

AT-Zahnriemenräder, Teilung 10 mm aus Aluminium

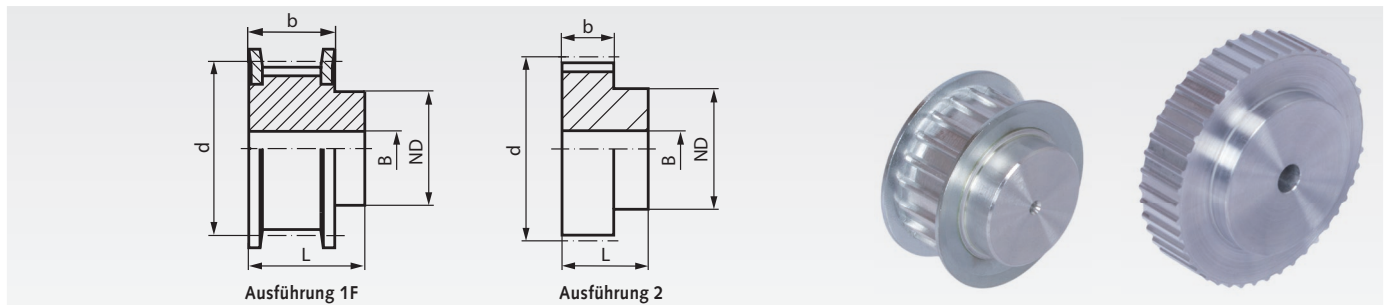

Werkstoff: Aluminium ähnlich EN AW2017A. Bordscheiben Stahl verzinkt.

Bestellangaben: z.B.: Art.-Nr. 168 215 00, Zahnriemenrad, Teilung AT 10, 15 Zähne, Zahnriemenbreite 16 mm

Profil AT 10, Zahnriemenbreite 16 mm

Artikel-Nr. Zahnriemenbreite 16 mm	Typ	Zähne- zahl	Aus- führung	Außen-Ø		d mm	ND mm	b mm	L mm	Vorbereitung		Gewicht g
				Zahnscheibe mm	Bordscheibe mm					B mm		
168 215 00	31 AT10/15-2	15	1F	45,90	51	47,75	32	21	31	8	116	
168 216 00	31 AT10/16-2	16	1F	49,05	54	50,93	35	21	31	8	134	
168 218 00	31 AT10/18-2	18	1F	55,45	60	57,30	40	21	31	8	167	
168 219 00	31 AT10/19-2	19	1F	58,65	66	60,48	44	21	31	8	184	
168 220 00	31 AT10/20-2	20	1F	61,80	66	63,66	46	21	31	8	208	
168 222 00	31 AT10/22-2	22	1F	68,20	75	70,03	52	21	31	8	253	
168 224 00	31 AT10/24-2	24	1F	74,55	83	76,39	58	21	31	8	288	
168 225 00	31 AT10/25-2	25	1F	77,75	83	79,58	60	21	31	8	310	
168 226 00	31 AT10/26-2	26	1F	80,90	87	82,76	60	21	31	8	357	
168 227 00	31 AT10/27-2	27	1F	84,10	91	85,94	60	21	31	8	364	
168 228 00	31 AT10/28-2	28	1F	87,25	93	89,13	60	21	31	8	401	
168 230 00	31 AT10/30-2	30	1F	93,65	97	95,49	60	21	31	8	441	
168 232 00	31 AT10/32-2	32	1F	100,00	106	101,86	65	21	31	10	493	
168 236 00	31 AT10/36-2	36	1F	112,75	119	114,59	70	21	31	10	623	
168 240 00	31 AT10/40-2	40	1F	125,45	131	127,32	80	21	31	10	767	
168 244 00	31 AT10/44-0	44	2	138,20	-	140,06	88	21	31	10	993	
168 248 00	31 AT10/48-0	48	2	150,95	-	152,79	95	21	31	16	1090	
168 260 00	31 AT10/60-0	60	2	189,10	-	190,99	110	21	31	16	1701	

Profil AT 10, Zahnriemenbreite 25 mm

Artikel-Nr. Zahnriemenbreite 25 mm	Typ	Zähne- zahl	Aus- führung	Außen-Ø		d mm	ND mm	b mm	L mm	Vorbereitung		Gewicht g
				Zahnscheibe mm	Bordscheibe mm					B mm		
168 315 00	40 AT10/15-2	15	1F	45,90	51	47,75	32	30	40	8	152	
168 316 00	40 AT10/16-2	16	1F	49,05	54	50,93	35	30	40	8	176	
168 318 00	40 AT10/18-2	18	1F	55,45	60	57,30	40	30	40	8	224	
168 319 00	40 AT10/19-2	19	1F	58,65	66	60,48	44	30	40	8	247	
168 320 00	40 AT10/20-2	20	1F	61,80	66	63,66	46	30	40	8	276	
168 322 00	40 AT10/22-2	22	1F	68,20	75	70,03	52	30	40	8	337	
168 324 00	40 AT10/24-2	24	1F	74,55	83	76,39	58	30	40	8	392	
168 325 00	40 AT10/25-2	25	1F	77,75	83	79,58	60	30	40	8	422	
168 326 00	40 AT10/26-2	26	1F	80,90	87	82,76	60	30	40	8	477	
168 327 00	40 AT10/27-2	27	1F	84,10	91	85,94	60	30	40	8	536	
168 328 00	40 AT10/28-2	28	1F	87,25	93	89,13	60	30	40	8	540	
168 330 00	40 AT10/30-2	30	1F	93,65	97	95,49	60	30	40	8	640	
168 332 00	40 AT10/32-2	32	1F	100,00	106	101,86	65	30	40	10	693	
168 336 00	40 AT10/36-2	36	1F	112,75	119	114,59	70	30	40	10	873	
168 340 00	40 AT10/40-2	40	1F	125,45	131	127,32	80	30	40	10	1067	
168 344 00	40 AT10/44-0	44	2	138,20	-	140,06	88	30	40	10	1350	
168 348 00	40 AT10/48-0	48	2	150,95	-	152,79	95	30	40	16	1516	
168 360 00	40 AT10/60-0	60	2	189,10	-	190,99	110	30	40	16	2339	

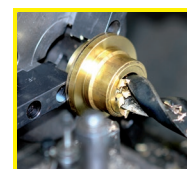

Fertigbearbeitung im
24-Stunden-Service möglich.
Sonderanfertigungen und
Zeichnungsteile auf Anfrage.