

FILTERING

FLAT CABLE FERRITES

Features

- Employ high-performance ferrites (Nickel-Zinc) effective against high frequency noise.
- Special mounting options include adhesive tape, or screw type through holes available.
- Designed to help reduce cost and time to market saving.
- Can be installed in its intended location before or after product assembly simply with Mounting part.

Applications

- Superior suppression of radiation emissions for full compliance with FCC, VDE and VCCI on Interface/data line ribbon cables of computers, peripheral/terminal equipment.

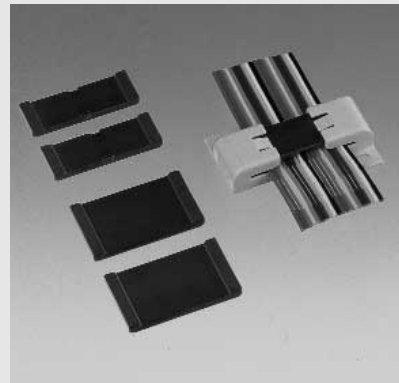
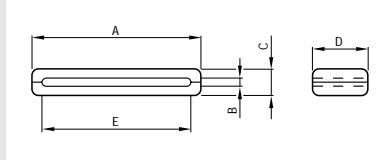

| Part No. | A | B | Unit: mm | | | Impedance (Ω) | | Max. Cable Width (mm) |
|-------------|------|-----|----------|----|----|------------------------|--------|-----------------------|
| | | | C | D | E | 25MHz | 100MHz | |
| SSH-33.5-12 | 33.5 | 1.2 | 6.6 | 12 | 27 | 33 | 63 | 26 |
| SSH-33.5-20 | 33.5 | 1.2 | 6.6 | 20 | 27 | 52 | 92 | 26 |
| SSH-40-12 | 40.0 | 1.2 | 6.6 | 12 | 35 | 27 | 61 | 34 |
| SSH-45-12 | 45.0 | 1.2 | 6.6 | 12 | 40 | 25 | 60 | 39 |

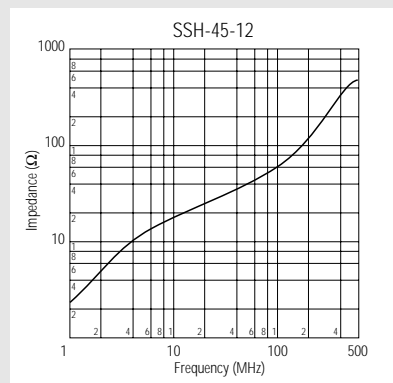
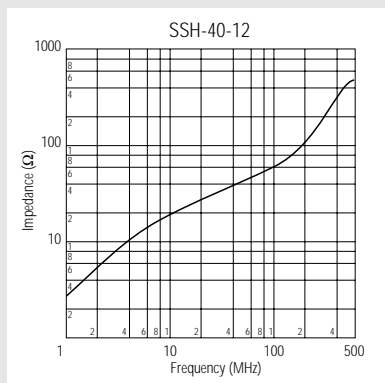
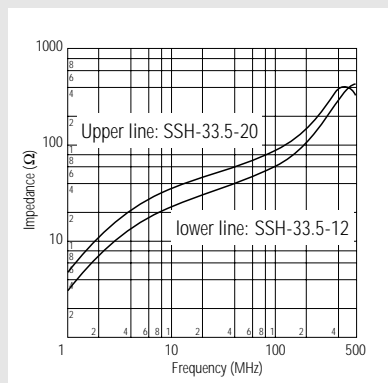

Mounting Parts for SSH type cores + SSC type cores

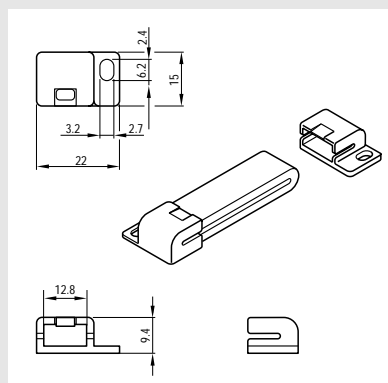

Part No.: FRH-12
Material: PA66 UL94V-0

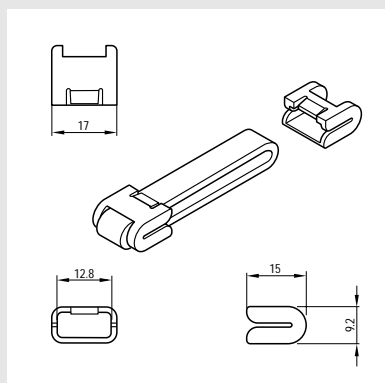

Part No.: FRC-12CP
Material: PA66 UL94V-0

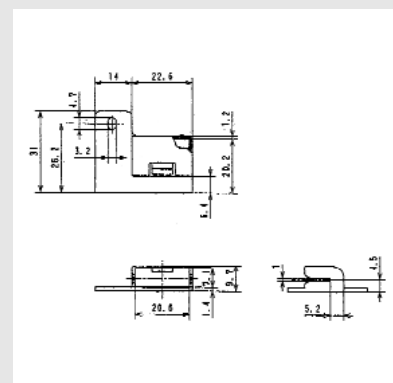

Part No.: FRHL-20
Material: PA66 UL94V-2

| Part No. | |
|----------|--|
| FRH-12 | Mounting part for screw ($D \geq 12\text{mm}$) |
| FRHL-20 | Mounting part for screw ($D \geq 20\text{mm}$) |
| FRC-12CP | Mounting part |

KE KITAGAWA

Elbinger Straße 3-5 · D-63110 Rodgau-Jügesheim · Germany · Telefon 0 61 06/85 24 - 0 · Telefax 0 61 06/85 24-30 (31)

FILTERING

FLAT CABLE FERRITES

Features

- Employ high-performance ferrites (Nickel-Zinc) effective against high frequency noise.
- Designed to help reduce cost and time to market saving.
- Can be installed in its intended location before or after product assembly.

Application

- Superior suppression of radiation emissions for full compliance with FCC, VDE and VCCI on Interface/data line ribbon cables of computers, peripheral/terminal equipment.

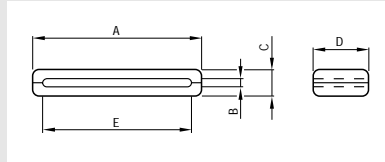
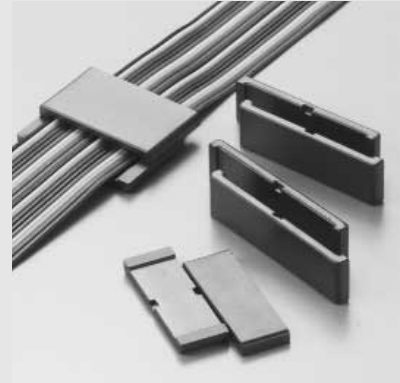

| Part No. | Unit: mm | | | | | Impedance (Ω) | | Max. Cable Width (mm) |
|---------------|----------|-----|-----|------|------|------------------------|--------|-----------------------|
| | A | B | C | D | E | 25MHz | 100MHz | |
| FPH-10-6-5 | 10 | 1.8 | 5.0 | 6.0 | 6.8 | 16 | 29 | 6.5 |
| FPH-10-10-5 | 10 | 1.8 | 5.0 | 10.0 | 6.8 | 22 | 48 | 6.5 |
| FPH-17-15-2,5 | 17.0 | 0.8 | 2.5 | 15.0 | 13.0 | 24 | 56 | 12.8 |
| FPH-31-12-3,5 | 31.0 | 0.4 | 3.5 | 12.0 | 27.0 | 17 | 46 | 26.5 |

No Mounting Parts available for all size

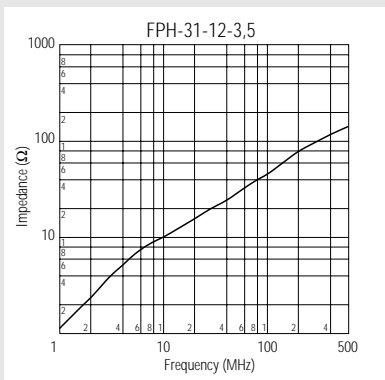
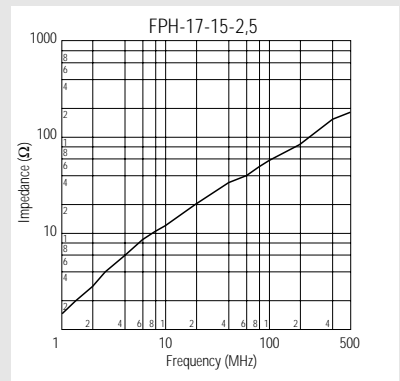
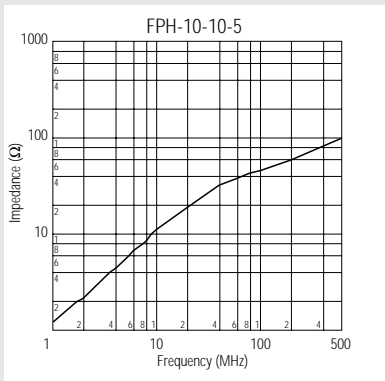
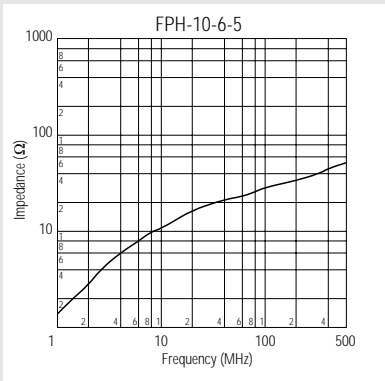

KE KITAGAWA

Elbinger Straße 3-5 · D-63110 Rodgau-Jügesheim · Germany · Telefon 0 61 06/85 24 - 0 · Telefax 0 61 06/85 24-30 (31)

FILTERING

FLAT CABLE FERRITES

Features

- Employ high-performance ferrites (Nickel-Zinc) effective against high frequency noise.
- Designed to help reduce cost and time to market saving.
- Can be installed in its intended location before product assembly.

Applications

- Superior suppression of radiation emissions for full compliance with FCC, VDE and VCCI on Interface/ data line Ribbon/FPC cables of computers, peripheral/terminal equipment.

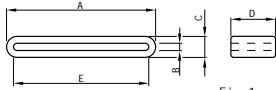
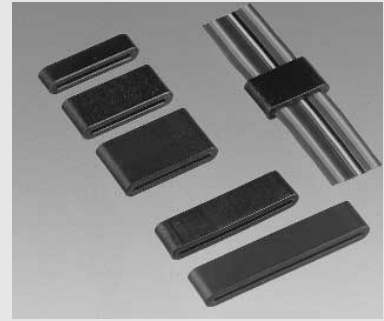

Fig.1

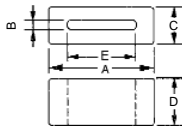

Fig.2

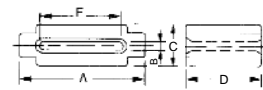
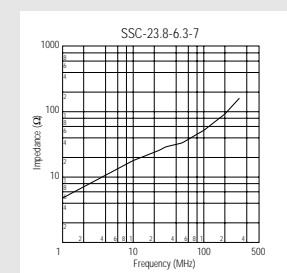
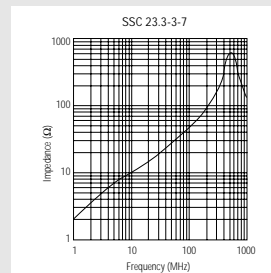
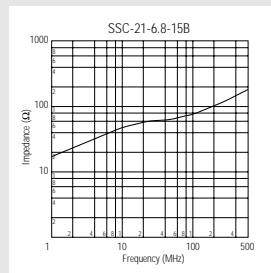
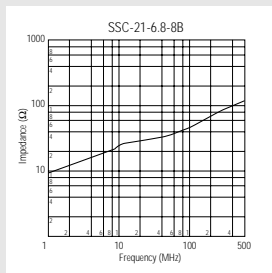

Fig.3

| Part No. | Fig. | Unit: mm | | | | | Impedance (Ω) | | Max. Cable Width (mm) |
|-------------------|------|-----------|--------------|------------|-----------|---------------|---------------|--------|-----------------------|
| | | A | B | C | D | E | 25MHz | 100MHz | |
| SSC-21-6.8-8B | 2 | 21.0±0.5 | 1.3+0.4/-0.1 | 6.8±0.3 | 8.0±0.3 | 15.0±0.5 | 32 | 44 | 14 |
| SSC-21-6.8-15B | 2 | 21.0±0.5 | 1.3+0.4/-0.1 | 6.8±0.3 | 15.0±0.4 | 15.0±0.5 | 60 | 75 | 14 |
| SSC-23.3-3-7 | 2 | 23.3±0.7 | 0.9±0.2 | 3.1±0.3 | 7.0±0.3 | 20.0±0.5 | 17 | 45 | 19 |
| SSC-23.8-6.3-7 | 1 | 23.8±0.7 | 1.3±0.25 | 6.3±0.3 | 7.0±0.3 | 18.4±0.5 | 27 | 58 | 18 |
| SSC-23.8-6.3-12.5 | 1 | 23.8±0.8 | 1.1±0.4 | 6.3±0.4 | 12.5±0.4 | 18.7±0.8 | 29 | 83 | 18 |
| SSC-23.8-6.3-15 | 1 | 23.8±0.8 | 1.1±0.4 | 6.3±0.4 | 15.0±0.4 | 18.7±0.8 | 46 | 88 | 18 |
| SSC-28.5-6.5-8 | 1 | 28.5±0.7 | 0.85±0.3 | 6.5±0.5 | 8.0±0.4 | 23.5±0.5 | 28 | 65 | 22 |
| SSC-28-7.7-14.6 | 3 | 28.0±0.8 | 1.4±0.2 | 7.7±0.3 | 14.6±0.4 | 23.0±0.5 | 55 | 115 | 22 |
| SSC-33.5-8 | 1 | 33.5±1.0 | 1.4±0.4 | 6.5±0.5 | 8.0±0.4 | 27.0±0.5 | 21 | 44 | 26 |
| SSC-33.5-10 | 1 | 33.5±1.0 | 1.4±0.4 | 6.5±0.5 | 10.0±0.4 | 27.0±0.5 | 26 | 51 | 26 |
| SSC-33.5-12 | 1 | 33.5±1.0 | 1.4±0.4 | 6.5±0.5 | 12.0±0.5 | 27.0±0.5 | 31 | 58 | 26 |
| SSC-33.5-10-2 | 1 | 33.5±0.9 | 2.2±0.3 | 7.4±0.4 | 10.0±0.5 | 27.0±0.9/-0.6 | 27 | 50 | 26 |
| SSC-33.5-20 | 1 | 33.5±0.9 | 1.4±0.4 | 6.5±0.5 | 20.0±0.6 | 27.15±0.75 | 58 | 149 | 26 |
| SSC-38.5-4-12 | 2 | 38.5±1.0 | 0.8±0.3 | 4.0±0.2 | 12.0±0.5 | 35.0±0.7 | 25 | 68 | 34 |
| SSC-38.5-12-25.4 | 2 | 38.5±0.58 | 1.9±0.38 | 12.06±0.38 | 25.4±0.76 | 26.77±0.76 | 86 | 166 | 26 |
| SSC-40-10 | 1 | 40.0±1.0 | 1.4±0.4 | 6.5±0.5 | 10.0±0.45 | 35.0±0.7 | 23 | 54 | 34 |
| SSC-40-12 | 1 | 40.0±1.0 | 1.4±0.4 | 6.5±0.5 | 12.0±0.5 | 35.0±0.7 | 27 | 60 | 34 |
| SSC-45-8 | 1 | 45.2±1.0 | 1.4±0.4 | 6.5±0.5 | 8.0±0.3 | 40.0±0.8 | 19 | 46 | 39 |
| SSC-45-12 | 1 | 45.2±1.0 | 1.4±0.4 | 6.5±0.5 | 12.0±0.5 | 40.0±0.8 | 26 | 61 | 39 |
| SSC-50-12 | 1 | 49.6±1.0 | 1.4±0.4 | 6.5±0.5 | 12.0±0.5 | 40.0±0.8 | 25 | 64 | 43 |
| SSC-58-12 | 1 | 57.6±1.20 | 1.4±0.4 | 6.5±0.5 | 12.0±0.5 | 52.0±0.8 | 25 | 63 | 51 |
| SSC-60-12 | 1 | 60.6±1.1 | 1.4±0.4 | 6.5±0.5 | 12.0±0.5 | 55.2±1.0 | 35 | 92 | 54 |

Mounting Parts Page 10 + 16



KE KITAGAWA

Elbinger Straße 3-5 · D-63110 Rodgau-Jügesheim · Germany · Telefon 0 61 06/85 24 - 0 · Telefax 0 61 06/85 24-30 (31)

FILTERING

FLAT CABLE FERRITES

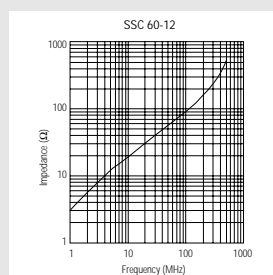
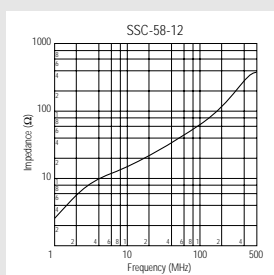
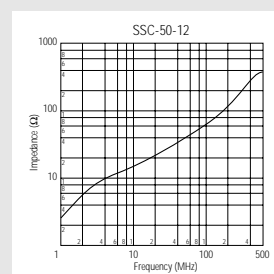
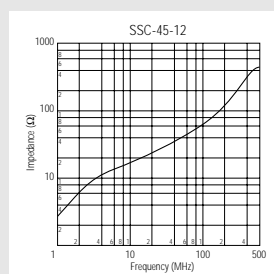
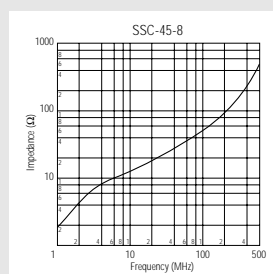
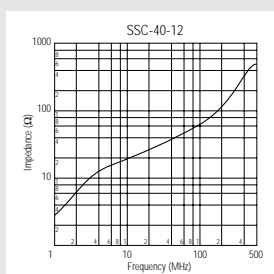
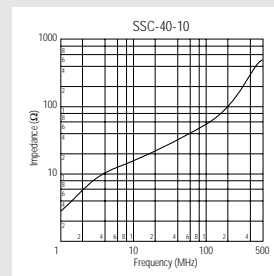
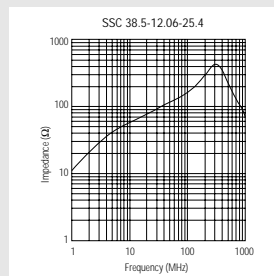
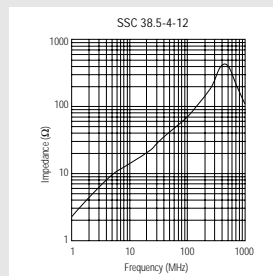
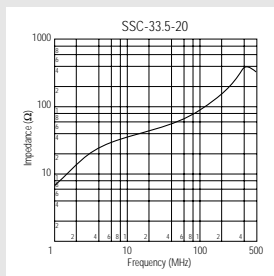
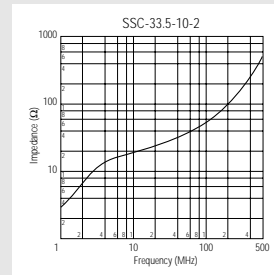
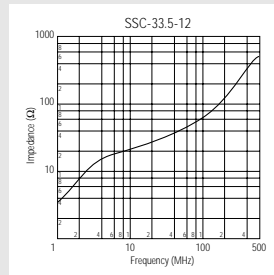
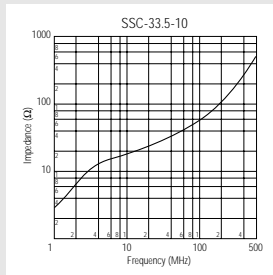
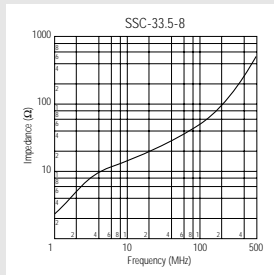
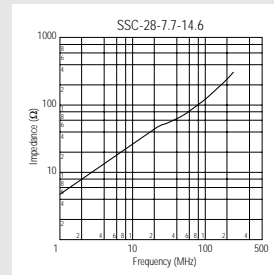
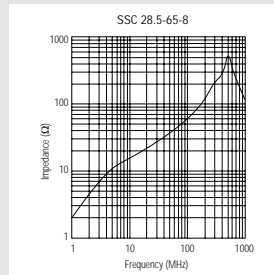
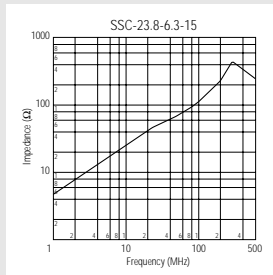
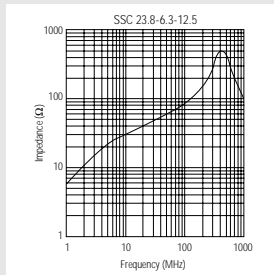

FILTERING

FLAT CABLE FERRITES

Features

- Employ high-performance ferrites (Nickel-Zinc) effective against high frequency noise.
- Designed to help reduce cost and time to market saving.
- Can be installed in its intended location before or after product assembly.

Application

- Superior suppression of radiation emissions for full compliance with FCC, VDE and VCCI on Interface data line ribbon cables of computers peripheral/terminal equipment.

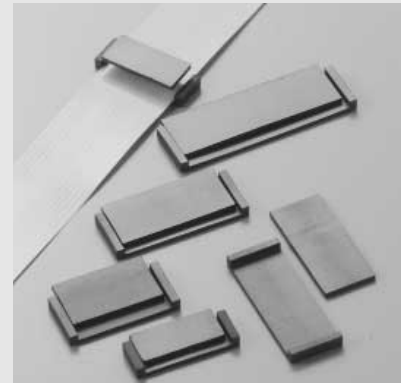
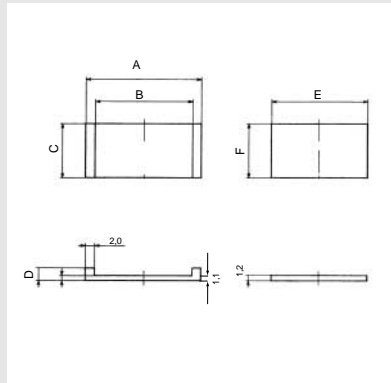

| Part No. | Unit: mm | | | | | | Impedance (Ω) | | Max. Cable Width (mm) |
|---------------|----------|------|------|-----|------|------|------------------------|--------|-----------------------|
| | A | B | C | D | E | F | 25MHz | 100MHz | |
| FPO-25-12-3 | 25.0 | 21.0 | 12.0 | 2.8 | 20.5 | 12.0 | 25 | 56 | 20.5 |
| FPO-31-12-3 | 31.0 | 27.0 | 12.0 | 2.8 | 26.5 | 12.0 | 24 | 55 | 26.6 |
| FPO-43-12-3 | 43.0 | 39.0 | 12.0 | 2.7 | 38.5 | 12.0 | 17 | 49 | 38.5 |
| FPI-20-12-1,2 | - | - | - | - | 20.5 | 12.0 | - | - | - |

No Mounting Parts available for all size

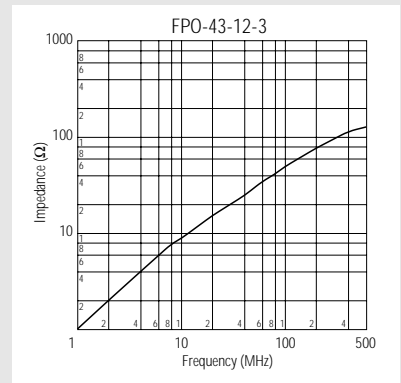
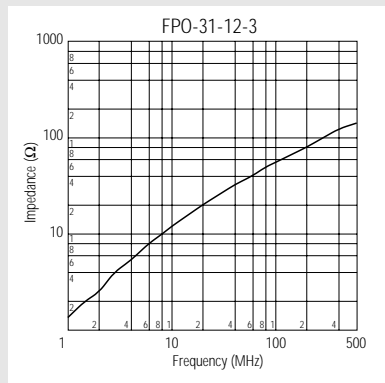
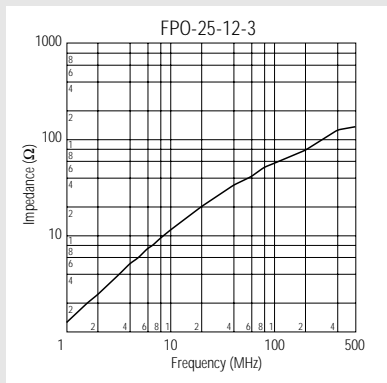

FILTERING

FLAT CABLE FERRITES

Features

- Employ high-performance ferrites (Nickel-Zinc) effective against high frequency noise.
- Designed to help reduce cost and time to market saving.
- Can be installed simply in its intended location before product assembly.
- Mounting part, FPCK12A, 12B is available

Applications

- Superior suppression of radiation emissions for full compliance with FCC, VDE and VCCI on Interface/data line FPC cables of computers, peripheral/terminal equipment.

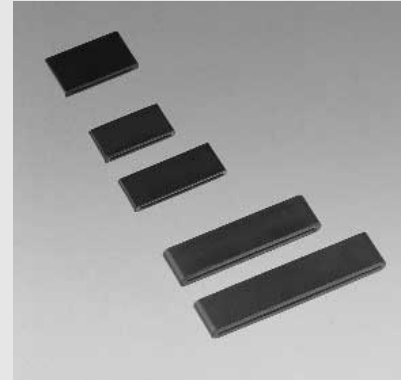
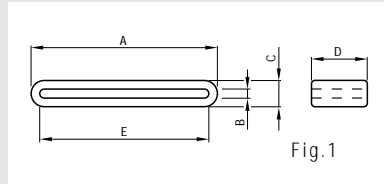

| Part No. | Unit: mm | | | | | Impedance (Ω) | | Max.Cable width (mm) |
|-------------|---------------|--------------|--------------|----------|----------|---------------|--------|----------------------|
| | A | B | C | D | E | 25MHz | 100MHz | |
| FPC 16-12 | 16.0±0.4 | 0.5+0.6/-0.0 | 5.0+0.0/-0.7 | 12.0±0.5 | 11.5±0.4 | 42 | 79 | 10.5 |
| FPC-16-20 | 16.0±0.4 | 0.5+0.6/-0.0 | 5.0+0.0/-0.7 | 20.0±0.6 | 11.5±0.4 | 71 | 127 | 10.5 |
| FPC-25-12 | 24.5±0.7 | 0.5+0.6/-0.0 | 5.0+0.0/-0.7 | 12.0±0.4 | 20.0±0.5 | 30 | 65 | 19.0 |
| FPC-25-20 | 24.5±0.7 | 0.85±0.25 | 5.0+0.0/-0.7 | 20.0±0.6 | 20.0±0.5 | 50 | 103 | 19.0 |
| FPC-31-12 | 31.0±1.0 | 1.0±0.2 | 5.0±0.3 | 12.0±0.5 | 27.0±0.7 | 26 | 66 | 26.0 |
| FPC-46-12 | 46.0+1.1/-0.8 | 0.5+1.0/-0.0 | 5+0.0/-0.8 | 12.0±0.8 | 41.5±0.9 | 23 | 65 | 40.5 |
| FPC-56-12 | 56.2±1.1 | 0.5+1.1/-0.0 | 5+0.3/-1.1 | 12.0±0.5 | 52.4±0.9 | 23 | 66 | 51.0 |
| FPC-24-12-3 | 23.3±0.7 | 0.9±0.2 | 3.1±0.3 | 12.0±0.5 | 20.0±0.5 | 20 | 41 | 19.0 |
| FPC-31-12-3 | 31.0±0.8 | 0.9±0.2 | 3.0±0.2 | 12.0±0.5 | 27.0±0.6 | 17 | 42 | 26.0 |

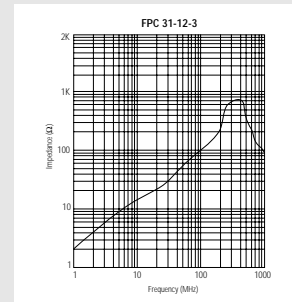
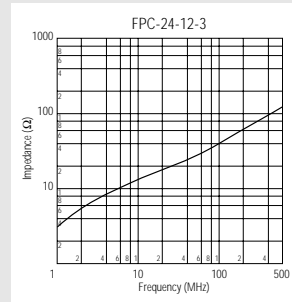
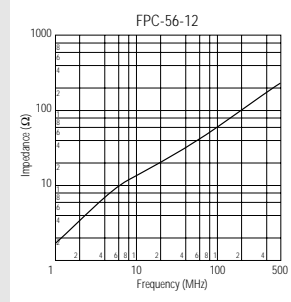
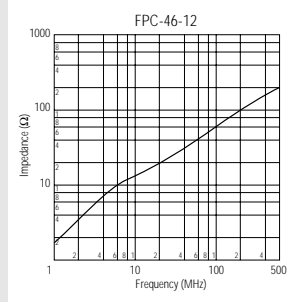
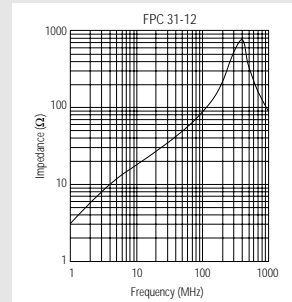
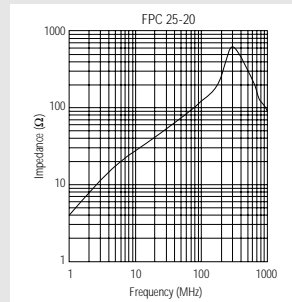
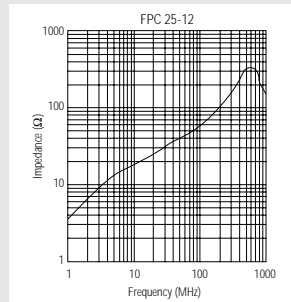
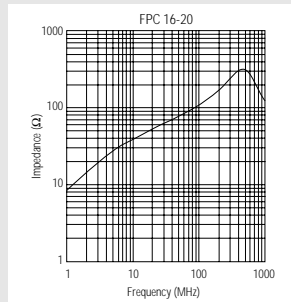
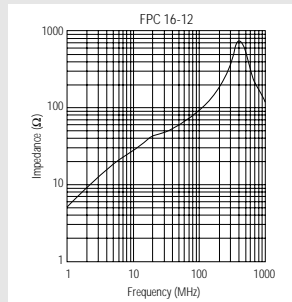

KE KITAGAWA

Elbinger Straße 3-5 · D-63110 Rodgau-Jügesheim · Germany · Telefon 0 61 06/85 24 - 0 · Telefax 0 61 06/85 24-30 (31)

FILTERING

FLAT CABLE FERRITES

Mounting Parts for FPC type cores

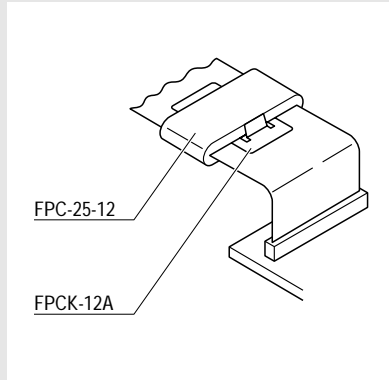

Part No.: FPCK-12B
 Material: PVC
 Applicable: FPC-31-12
 FPC-46-12
 FPC-56-12
 FPC-31-12-3

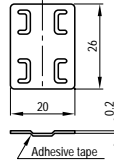

Part No.: FPCK-12A
 Material: PVC
 Applicable: FPC-16-12
 FPC-25-12
 FPC-24-12-3

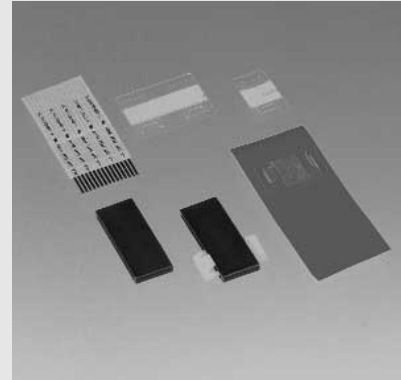
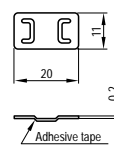

| Part No. | Applicable |
|----------|--|
| FPCK-12B | FPC-31-12; FPC-46-12; FPC-56-12; FPC-31-12-3 |
| FPCK-12A | FPC-16-12; FPC-25-12; FPC-24-12-3 |

Mounting Parts for SSC type cores

Features

- Plastic clip for SSC-cores
- Material: ABS
- Colour: black

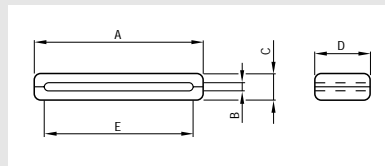

| Part No. | Unit: mm | | | | | Applicable |
|----------|----------|-----|------|------|------|---|
| | A | B | C | D | E | |
| FCP-15P | 34,5 | 0,8 | 12,0 | 19,0 | 21,6 | SSC-21-6,8-8 / 21-6,8-15 / 23,8-6,3-7 / 23,8-6,3-15 / 28-7-14,6 |
| FCP-25P | 46,5 | 0,8 | 10,6 | 16,0 | 34,3 | SSC-33,5-8 / 33,5-10 / 33,5-12 / 33,5-10-2 / 40-10 / 40-12 |
| FCP-34P | 56,6 | 0,8 | 10,4 | 16,0 | 43,2 | SSC-45-8 / 45-12 / 50-12 |
| FCP-40P | 64,1 | 0,8 | 10,4 | 16,0 | 53,3 | SSC-58-12 |

FILTERING

FLAT CABLE FERRITES

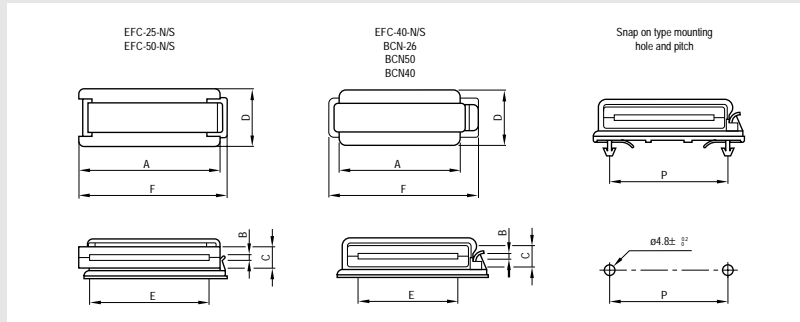

Features

- Split construction permits easy insertion of cables already wired and installed, or cables with connectors.
- Nylon mounting clamp comes with.
- Split block cores supported with plastic mounting clamp for flat cables

Applications

- For noise problems arising in office automation equipment or other digital equipment.

| Part No. | Unit: mm | | | | | | | Impedance (Ω) | | Applicable cable |
|----------|----------|-----|------|------|------|------|------|---------------|--------|--|
| | A | B | C | D | E | F | P | 25MHz | 100MHz | |
| EFC-25S | 44.0 | 2.0 | 13.0 | 28.5 | 33.0 | 47.0 | 33.0 | 65 | 150 | flat cable Less than the dimension E |
| EFC-40S | 63.0 | 2.0 | 13.0 | 28.5 | 52.0 | 77.0 | 64.5 | 72 | 175 | |
| EFC-50S | 76.5 | 2.0 | 13.0 | 28.5 | 64.5 | 79.5 | 64.5 | 62 | 185 | |
| EFC-25N | 44.0 | 2.0 | 13.0 | 28.5 | 33.0 | 47.0 | — | 65 | 150 | |
| EFC-40N | 63.0 | 2.0 | 13.0 | 28.5 | 52.4 | 77.0 | — | 72 | 175 | |
| EFC-50N | 76.5 | 2.0 | 13.0 | 28.5 | 64.5 | 79.5 | — | 62 | 185 | |
| BCN-26 | 45.0 | 2.0 | 13.0 | 28.5 | 34.0 | 59.0 | — | 92 | 180 | |
| BCN-40 | 63.0 | 2.0 | 13.0 | 28.5 | 52.0 | 76.5 | — | 72 | 180 | |
| BCN-50 | 76.5 | 2.0 | 13.0 | 28.5 | 64.5 | 90.7 | — | 63 | 185 | |

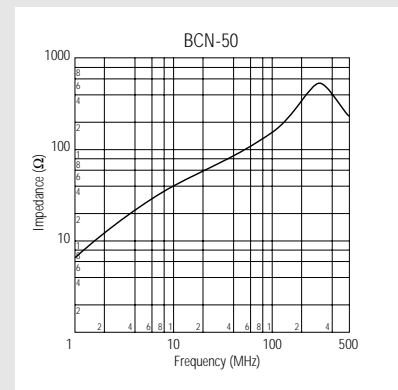
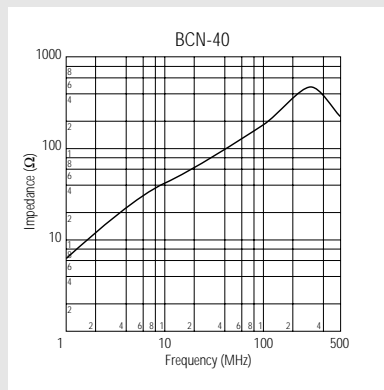
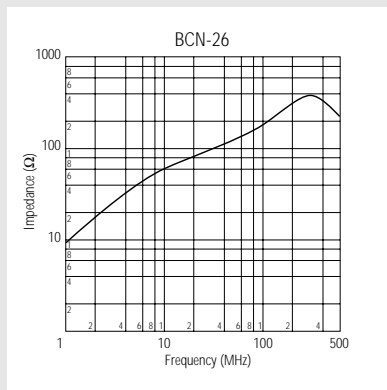
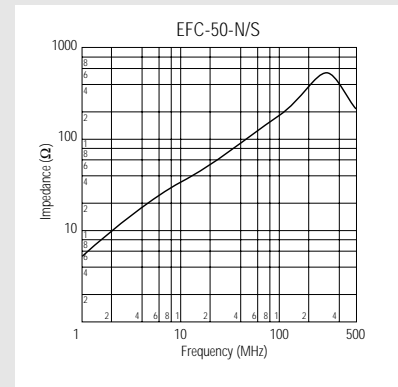
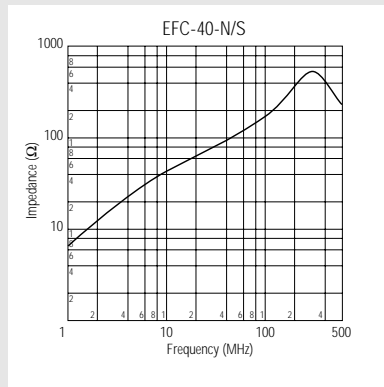
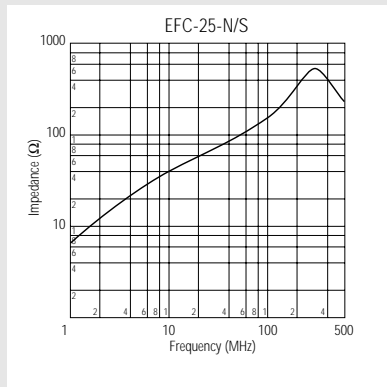

FILTERING

FLAT CABLE FERRITES

Features

- Kitagawa offers a line of bisected flat cable suppression cores to attenuate radiated EMI emissions from ribbon cables.
- Ferrite assembly press-fitted into a pair of metal clips.
- Metal clips included, except FP 16,5-2-10.25

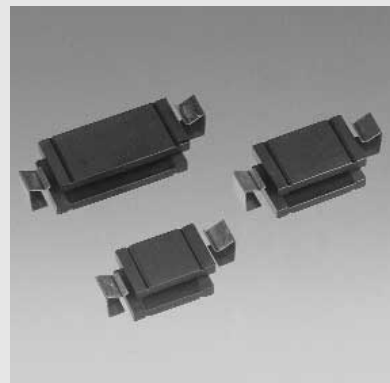
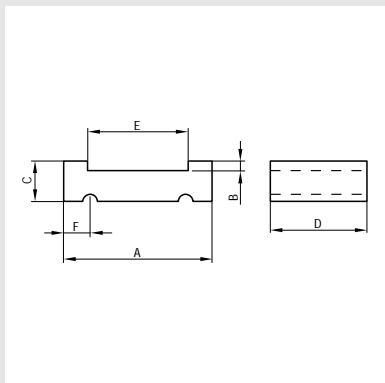

Applications

- Internal ribbon cables between PCB and Data line.
- To suppress radiated EMI emission from flat cable and ribbon cable.

| Part No. | | Unit: mm | | | | | Impedance (Ω) | |
|-------------------|----|-----------|---------|-----------|-----------|----------|------------------------|--------|
| | | A | B | C | D | E | 25MHz | 100MHz |
| FP 16.5-2-10.25 | | 16.5±0.25 | 0.6±0.2 | 2.0±0.2 | 10.25±0.2 | 12.5±0.3 | 29 | 72 |
| FP 38-6.35-10 | * | 38.0±1.0 | 0.8±0.2 | 6.35±0.25 | 10.0±0.4 | 26.6±0.7 | 45 | 107 |
| FP 38-6.35-25.4 | * | 38.0±1.0 | 0.8±0.2 | 6.35±0.25 | 25.4±0.75 | 26.6±0.7 | 103 | 173 |
| FP 45-6.35-10 | * | 45.0±0.75 | 0.8±0.2 | 6.35±0.25 | 10.0±0.4 | 34.4±0.7 | 41 | 98 |
| FP 45-6.35-28.5 | ** | 45.0±0.75 | 0.8±0.2 | 6.35±0.25 | 28.5±0.7 | 34.4±0.7 | 84 | 166 |
| FP 55.1-6.35-28.5 | ** | 55.1±1.2 | 0.8±0.2 | 6.35±0.25 | 28.5±0.7 | 43.7±1.0 | 78 | 179 |
| FP 63.5-6.35-13 | * | 63.5±1.3 | 0.8±0.2 | 6.35±0.25 | 13.0±0.4 | 52.0±1.1 | 45 | 114 |
| FP 63.5-6.35-15 | * | 63.5±1.3 | 0.8±0.2 | 6.35±0.25 | 15.0±0.4 | 52.0±1.1 | 50 | 124 |
| FP 63.5-6.35-28.5 | ** | 63.5±1.3 | 0.8±0.2 | 6.35±0.25 | 28.5±0.7 | 52.0±1.1 | 74 | 155 |
| FP 76.2-6.35-28.5 | ** | 76.2±1.5 | 0.8±0.2 | 6.35±0.25 | 28.5±0.7 | 65.3±1.3 | 72 | 200 |

* Metal clips (KE-MC-10 or KE MC-13) are included

** Metal clips (KE-MC-13) are included, however Plastic clip KE-PC-28.5 is also available as option

Metal Clip for FP-core

Features

- Metal clip for FP-core
- Part No. KE-MC-10
- Part No. KE-MC-13

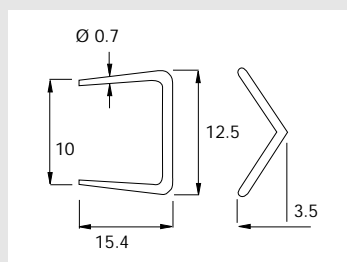

KE-MC-10

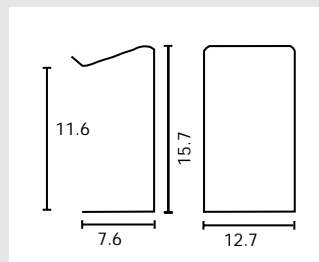

KE-MC-13

KE KITAGAWA

Elbinger Straße 3-5 · D-63110 Rodgau-Jügesheim · FR-Germany · Telefon 0 61 06/85 24 - 0 · Telefax 0 61 06/85 24-30 (31)

FILTERING

FLAT CABLE FERRITES

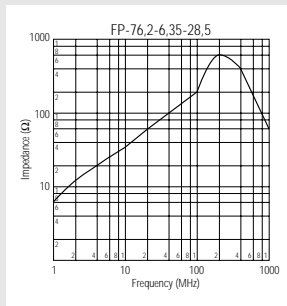
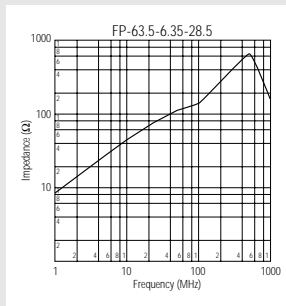
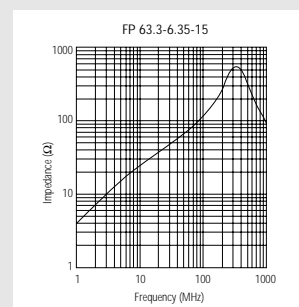
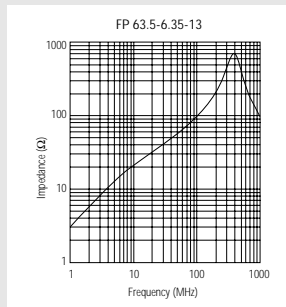
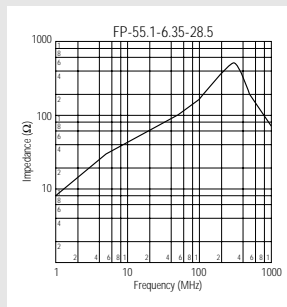
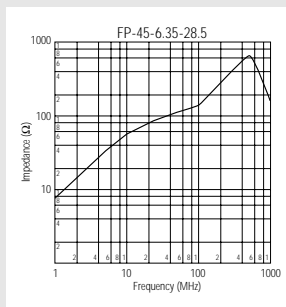
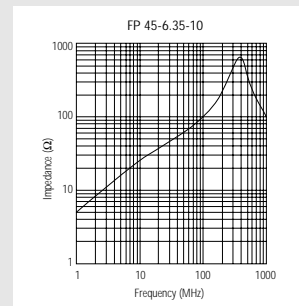
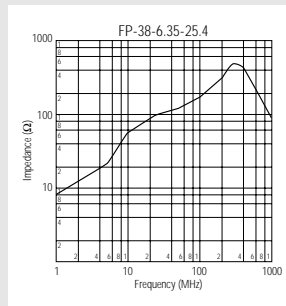
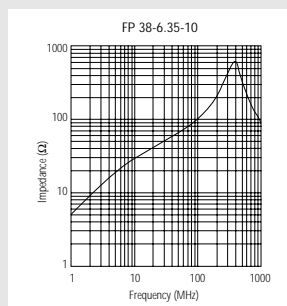
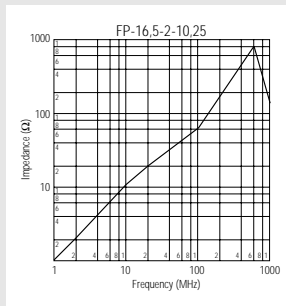

Mounting parts for FP-cores

Features

- Plastic clip for FP- cores
- Nylon 6.6 (UL 94 V-2)
- Colour grey
- Screw mounting
- Part No. KE-PC-28.5

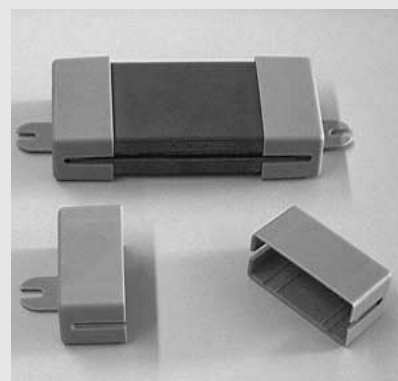
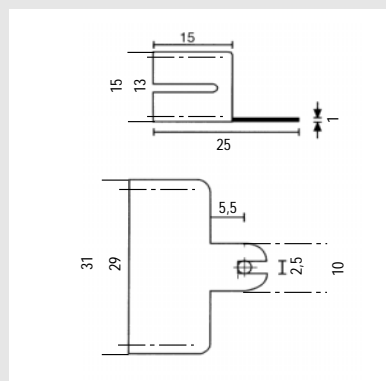

KE-PC-28.5