

QFP, PQFP, TQFP (Clamshell)

IC51 Series

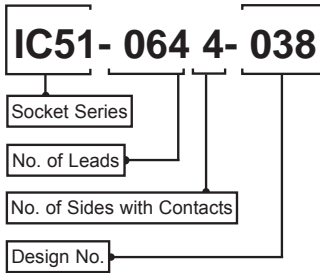

Characteristics

Insulation Resistance: 1,000M Ω minimum at 500 VDC
 Withstanding Voltage: 700 VAC for 1 minute
 Contact Resistance: 30m Ω max. at 10mA/20mV (Initial)
 Operating Temperature: PES/PEI -55°C ~ +170°C
 PSF -40°C ~ +150°C

Material

Insulator: PSF / PES / PEI
 Contact: Beryllium Copper
 Plating: Gold over Nickel

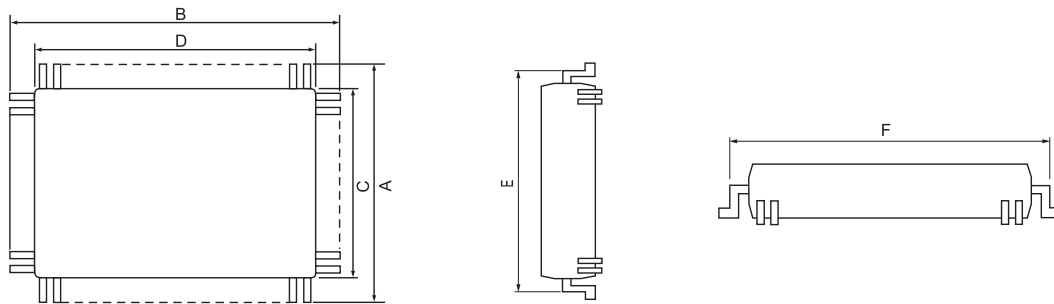

(Reference Only)

| Part Number | No. of Leads | Body Size | Pitch | Matching Package Size | | | | | | Notes |
|------------------|--------------|-----------|-------|-----------------------|------|------|------|---------|---------|----------------|
| | | | | A | B | C | D | E (Max) | F (Max) | |
| IC51-0324-805 | 32 | 5 x 5 | 0.5 | 7.0 | 7.0 | 5.0 | 5.0 | 6.2 | 6.2 | Floating Base |
| IC51-0324-354 | 32 | 7 x 7 | 0.8 | 9.0 | 9.0 | 7.0 | 7.0 | 8.4 | 8.4 | |
| IC51-0324-1498 | 32 | 7 x 7 | 0.8 | 9.0 | 9.0 | 7.0 | 7.0 | 8.4 | 8.4 | |
| QFP11T044-001* | 44 | 10 x 10 | 0.8 | 12.0 | 12.0 | 10.0 | 10.0 | 11.3 | 11.3 | |
| IC51-0444-1195-3 | 44 | 10 x 10 | 0.8 | 12.6 | 12.6 | 10.0 | 10.0 | 11.5 | 11.5 | |
| IC51-0444-825 | 44 | 10 x 10 | 0.8 | 12.6 | 12.6 | 10.0 | 10.0 | 11.7 | 11.7 | |
| IC51-467-KS11247 | 44 | 10 x 10 | 0.8 | 13.2 | 13.2 | 10.0 | 10.0 | 12.0 | 12.0 | IC248-0444-001 |
| IC51-0444-798 | 44 | 10 x 10 | 0.8 | 13.9 | 13.9 | 10.0 | 10.0 | 12.9 | 12.9 | |
| IC51-0444-615 | 44 | 14 x 14 | 1.0 | 17.2 | 17.2 | 14.0 | 14.0 | 15.8 | 15.8 | |
| IC51-621-KS8966 | 44 | 14 x 14 | 1.0 | 17.9 | 17.9 | 14.0 | 14.0 | 16.5 | 16.5 | |
| IC51-0484-806 | 48 | 7 x 7 | 0.5 | 9.0 | 9.0 | 7.0 | 7.0 | 8.2 | 8.2 | Floating Base |
| IC51-0484-081 | 48 | 12 x 12 | 0.8 | 15.3 | 15.3 | 12.0 | 12.0 | 14.0 | 14.0 | |

*Note: New tooling part number.

QFP, PQFP, TQFP (Clamshell)

IC51 Series

(Reference Only)

| Part Number | No. of Leads | Body Size | Pitch | Matching Package Size | | | | | | Notes |
|-------------------|--------------|-----------|-------|-----------------------|------|------|------|---------|---------|---------------------------|
| | | | | A | B | C | D | E (Max) | F (Max) | |
| IC51-0484-630 | 48 | 12 x 12 | 0.8 | 16.9 | 16.9 | 12.0 | 12.0 | 15.0 | 15.0 | |
| IC51-0484-831-2 | 48 | 14 x 14 | 1.0 | 17.2 | 17.2 | 14.0 | 14.0 | 15.8 | 15.8 | |
| IC51-0484-831-1 | 48 | 14 x 14 | 1.0 | 17.9 | 17.9 | 14.0 | 14.0 | 16.8 | 16.8 | |
| IC51-0524-1612 | 52 | 10 X 10 | 0.65 | 12.0 | 12.0 | 10.0 | 10.0 | 11.2 | 11.2 | Handmade |
| IC51-0564-680 | 56 | 10 X 10 | 0.65 | 13.2 | 13.2 | 10.0 | 10.0 | 11.8 | 11.8 | |
| IC51-0564-924 | 56 | 10 X 14 | 0.8 | 13.2 | 17.2 | 10.0 | 14.0 | 11.8 | 15.8 | |
| IC51-0564-790 | 56 | 16 X 20 | 1.0 | 19.2 | 23.2 | 16.0 | 20.0 | 17.7 | 21.8 | |
| IC51-0564-1056 | 56 | 10 X 10 | 0.7 | 13.2 | 13.2 | 10.0 | 10.0 | 11.8 | 11.8 | |
| IC51-0604-468 | 60 | 14 X 14 | 0.8 | 17.2 | 17.2 | 14.0 | 14.0 | 15.8 | 15.8 | |
| IC51-0604-104 | 60 | 14 X 14 | 0.8 | 17.9 | 17.9 | 14.0 | 14.0 | 16.4 | 16.4 | |
| IC51-0604-291 | 60 | 14 X 14 | 0.8 | 17.9 | 17.9 | 14.0 | 14.0 | 16.7 | 16.7 | w/ Separator |
| IC51-0604-497-2 | 60 | 16 X 20 | 1.0 | 17.9 | 23.9 | 16.0 | 20.0 | 17.0 | 23.0 | |
| IC51-0644-807 | 64 | 10 X 10 | 0.5 | 12.0 | 12.0 | 10.0 | 10.0 | 11.3 | 11.3 | FB lidless IC201-0644-003 |
| IC51-0644-1586 | 64 | 12 X 12 | 0.65 | 15.3 | 15.3 | 12.0 | 12.0 | 13.9 | 13.9 | Floating Base / Lidless |
| IC51-1240-AC03026 | 64 | 14 X 14 | 0.8 | 16.0 | 16.0 | 14.0 | 14.0 | 15.3 | 15.3 | |
| IC51-0644-824-3 | 64 | 14 X 14 | 0.8 | 16.2 | 16.2 | 14.0 | 14.0 | 15.4 | 15.4 | |
| IC51-0644-824-1 | 64 | 14 X 14 | 0.8 | 17.2 | 17.2 | 14.0 | 14.0 | 15.8 | 15.8 | |
| IC51-0644-824-2 | 64 | 14 X 14 | 0.8 | 17.9 | 17.9 | 14.0 | 14.0 | 16.7 | 16.7 | |
| IC51-0644-824-5 | 64 | 14 X 14 | 0.8 | 16.0 | 16.0 | 14.0 | 14.0 | 15.2 | 15.2 | |
| IC51-0644-820-2 | 64 | 14 X 20 | 1.0 | 17.6 | 23.6 | 14.0 | 20.0 | 16.3 | 22.3 | |
| IC51-820-2-KS9376 | 64 | 14 X 20 | 1.0 | 17.9 | 23.9 | 14.0 | 20.0 | 16.8 | 22.8 | Lidless IC201-0644-019 |
| IC51-0644-820-1 | 64 | 14 X 20 | 1.0 | 18.7 | 24.7 | 14.0 | 20.0 | 17.0 | 23.0 | |
| IC51-0684-734 | 68 | 10 X 14 | 0.65 | 13.2 | 17.2 | 10.0 | 14.0 | 11.8 | 15.8 | |
| IC51-0684-730 | 68 | 27 X 27 | 1.27 | 30.0 | 30.0 | 27.0 | 27.0 | 27.5 | 27.5 | Handmade w/ Separator |
| IC51-0724-119 | 72 | 16 X 20 | 0.8 | 18.0 | 23.0 | 16.0 | 20.0 | 16.6 | 21.5 | |
| IC51-0724-698 | 73 | 16 X 20 | 0.8 | 18.2 | 23.1 | 16.0 | 20.0 | 16.5 | 21.4 | |
| IC51-0804-808 | 80 | 12 X 12 | 0.5 | 14.0 | 14.0 | 12.0 | 12.0 | 13.3 | 13.3 | FB IC201-0804-014 |
| IC51-0804-795 | 80 | 14 X 14 | 0.65 | 16.0 | 16.0 | 14.0 | 14.0 | 15.3 | 15.3 | |
| IC51-0804-711 | 80 | 14 X 14 | 0.65 | 17.2 | 17.2 | 14.0 | 14.0 | 15.8 | 15.8 | |
| IC51-0804-956-2 | 80 | 14 X 14 | 0.65 | 17.2 | 17.2 | 14.0 | 14.0 | 16.0 | 16.0 | IC149-080-017-S5 |
| IC51-0804-819-6 | 80 | 14 X 20 | 0.8 | 17.2 | 23.2 | 14.0 | 20.0 | 15.8 | 21.8 | |
| IC51-819-KS12720 | 80 | 14 X 20 | 0.8 | 17.2 | 23.2 | 14.0 | 20.0 | 16.3 | 22.3 | IC201-0804-032 |
| IC51-0804-819-2 | 80 | 14 X 20 | 0.8 | 17.6 | 23.6 | 14.0 | 20.0 | 16.3 | 22.3 | |
| IC51-0804-819-1 | 80 | 14 X 20 | 0.8 | 17.9 | 23.9 | 14.0 | 20.0 | 16.8 | 22.8 | Lidless IC201-0804-005 |
| IC51-0884-999 | 88 | 20 X 20 | 0.8 | 23.0 | 23.0 | 20.0 | 20.0 | 22.3 | 22.3 | |
| IC51-0884-1290 | 88 | 12 X 12 | 0.5 | 14.0 | 14.0 | 12.0 | 12.0 | 13.3 | 13.3 | FB |
| IC51-1004-809 | 100 | 14 X 14 | 0.5 | 16.0 | 16.0 | 14.0 | 14.0 | 15.2 | 15.2 | Lidless IC201-1004-008 |
| IC51-1004-814-6 | 100 | 14 X 20 | 0.7 | 17.2 | 23.2 | 14.0 | 20.0 | 15.8 | 21.8 | |
| IC51-1004-814-13 | 100 | 14 X 20 | 0.65 | 16.0 | 22.0 | 14.0 | 20.0 | 15.2 | 21.2 | |
| IC51-814-KS12033 | 100 | 14 X 20 | 0.65 | 17.2 | 23.2 | 14.0 | 20.0 | 16.4 | 22.4 | Lidless IC201-1004-028 |

Quad Flat Packages

QFP, PQFP, TQFP (Clamshell)

IC51 Series

(Reference Only)

| Part Number | No. of Leads | Body Size | Pitch | Matching Package Size | | | | | | Notes |
|--------------------|--------------|-------------|-------|-----------------------|-------|-------|-------|---------|---------|---------------------------|
| | | | | A | B | C | D | E (Max) | F (Max) | |
| IC51-1004-814-2 | 100 | 14 x 20 | 0.65 | 17.6 | 23.6 | 14.0 | 20.0 | 16.4 | 22.4 | |
| IC51-1004-814-1 | 100 | 14 x 20 | 0.65 | 17.9 | 23.9 | 14.0 | 20.0 | 17.0 | 23.0 | FB/Lidless IC201-1004-016 |
| IC51-1004-567 | 100 | 22 x 22 | 0.8 | 27.8 | 27.8 | 22.0 | 22.0 | 25.8 | 25.8 | Dead Bug Loading |
| IC51-1124-1036-2 | 112 | 20 x 20 | 0.65 | 23.3 | 23.3 | 20.0 | 20.0 | 22.3 | 22.3 | |
| IC51-1204-1812 | 120 | 14 x 14 | 0.4 | 16.0 | 16.0 | 14.0 | 14.0 | 15.2 | 15.2 | Floating Base |
| IC51-1204-1497 | 120 | 28 x 28 | 0.8 | 31.2 | 31.2 | 28.0 | 28.0 | 30.0 | 30.0 | |
| IC51-1204-1646 | 120 | 28 x 28 | 0.8 | 32.0 | 32.0 | 28.0 | 28.0 | 30.8 | 30.8 | |
| IC51-1204-1652 | 120 | 16 x 16 | 0.5 | 18.4 | 18.4 | 16.0 | 16.0 | 17.5 | 17.5 | FB/IC201-1204-017 |
| IC51-1497-KS11444 | 120 | 28 x 28 | 0.8 | 31.9 | 31.9 | 28.0 | 28.0 | 30.5 | 30.5 | |
| IC51-1284-844-3 | 128 | 28 x 28 | 0.8 | 31.9 | 31.9 | 28.0 | 28.0 | 30.6 | 30.6 | w/Separator |
| IC51-1284-1433 | 128 | 14 x 20 | 0.5 | 16.0 | 22.0 | 14.0 | 20.0 | 15.0 | 21.0 | Floating Base / TQFP |
| IC51-1284-1433-10 | 128 | 14 x 20 | 0.5 | 17.2 | 23.2 | 14.0 | 20.0 | 16.4 | 22.4 | Floating Base |
| IC51-1284-1788 | 128 | 14 x 14 | 0.4 | 16.0 | 16.0 | 14.0 | 14.0 | 15.3 | 15.3 | Floating Base |
| IC51-1284-976-2 | 128 | 28 x 28 | 0.80 | 31.2 | 31.2 | 28.0 | 28.0 | 30.0 | 30.0 | |
| IC51-1284-976-1 | 128 | 28 x 28 | 0.80 | 31.9 | 31.9 | 28.0 | 28.0 | 30.5 | 30.5 | Lidless IC200-1284-001 |
| IC51-1444-1354 | 144 | 20 x 20 | 0.5 | 22.0 | 22.0 | 20.0 | 20.0 | 21.2 | 21.2 | Floating Base |
| IC51-1444-1354-7 | 144 | 20 x 20 | 0.5 | 22.0 | 22.0 | 20.0 | 20.0 | 21.3 | 21.3 | Floating Base / TQFP |
| IC51-1354-KS11590 | 144 | 20 x 20 | 0.5 | 23.2 | 23.2 | 22.0 | 22.0 | 22.3 | 22.3 | Floating Base |
| IC51-1444-1014-3 | 144 | 28 x 28 | 0.65 | 31.2 | 31.2 | 28.0 | 28.0 | 30.4 | 30.4 | |
| IC51-1014-KS11225 | 144 | 28 x 28 | 0.65 | 31.6 | 31.6 | 28.0 | 28.0 | 30.6 | 30.6 | |
| IC51-1014-KS12626 | 144 | 28 x 28 | 0.65 | 32.0 | 32.0 | 28.0 | 28.0 | 31.0 | 31.0 | |
| IC51-1505-AC07095 | 160 | 24 x 24 | 0.50 | 26.0 | 26.0 | 24.0 | 24.0 | 25.3 | 25.3 | SFB / TQFB |
| IC51-1604-1350 | 160 | 24 x 24 | 0.50 | 26.0 | 26.0 | 24.0 | 24.0 | 25.2 | 25.2 | Floating Base |
| IC51-1604-1350-2 | 160 | 24 x 24 | 0.5 | 26.0 | 26.0 | 24.0 | 24.0 | 25.3 | 25.3 | Floating Base / TQFP |
| IC51-1604-845-4 | 160 | 28 x 28 | 0.65 | 31.2 | 31.2 | 28.0 | 28.0 | 30.0 | 30.0 | Lidless IC201-1604-006 |
| IC51-1604-845-1 | 160 | 28 x 28 | 0.65 | 31.9 | 31.9 | 28.0 | 28.0 | 30.5 | 30.5 | |
| IC51-1764-1995-6 | 176 | 20 x 20 | 0.4 | 22.0 | 22.0 | 20.0 | 20.0 | 21.2 | 21.2 | Floating Base / TQFP |
| IC51-1764-1505 | 176 | 24 x 24 | 0.5 | 26.0 | 26.0 | 24.0 | 24.0 | 25.3 | 25.3 | Floating Base |
| IC51-1764-1505-5 | 176 | 24 x 24 | 0.5 | 26.0 | 26.0 | 24.0 | 24.0 | 25.3 | 25.3 | Floating Base / TQFP |
| IC51-1844-1148-1 | 184 | 32 x 32 | 0.65 | 35.2 | 35.2 | 32.0 | 32.0 | 33.7 | 33.7 | Floating Base |
| IC51-1844-1541 | 184 | 32 x 32 | 0.65 | 35.75 | 35.75 | 32.0 | 32.0 | 34.0 | 34.0 | Floating Base |
| IC51-1964-1952 | 196 | 32.29x32.29 | 0.64 | — | — | 32.3 | 32.3 | 56.5 | 56.5 | NCTB |
| IC51-2084-1052-* † | 208 | 28 x 28 | 0.5 | — | — | 28.0 | 28.0 | — | — | Floating Base |
| IC51-2084-1509 | 208 | 28 x 28 | 0.5 | 30.6 | 30.6 | 28.0 | 28.0 | 29.9 | 29.9 | MQUAD® |
| IC51-2404-1655-2 | 240 | 32 x 32 | 0.5 | 34.6 | 34.6 | 32.0 | 32.0 | 33.8 | 33.8 | Floating Base |
| IC51-2404-1655-3 | 240 | 32 x 32 | 0.5 | 34.6 | 34.6 | 31.6 | 31.6 | 33.7 | 33.7 | Floating Base / TQFP |
| IC51-2404-1655-4 | 240 | 32 x 32 | 0.5 | 34.0 | 34.0 | 32.0 | 32.0 | 33.4 | 33.4 | Floating Base / TQFP |
| IC51-2564-1668 | 256 | 28 x 28 | 0.4 | 30.6 | 30.6 | 28.0 | 28.0 | 29.9 | 29.9 | Floating Base |
| IC51-2564-1668-9 | 256 | 28 x 28 | 0.4 | 30.6 | 30.6 | 28.0 | 28.0 | 29.4 | 29.4 | Floating Base |
| IC51-2564-1668-10 | 256 | 28 x 28 | 0.4 | 30.0 | 30.0 | 28.0 | 28.0 | 29.4 | 29.4 | Floating Base / TQFP |
| IC51-2564-1668-15 | 256 | 28 x 28 | 0.4 | 30.0 | 30.0 | 28.0 | 28.0 | 29.2 | 29.2 | Floating Base / TQFP |
| QFP12T256-001 | 256 | 42 x 42 | 0.5 | 46.4 | 46.4 | 42.0 | 42.0 | 45.0 | 45.0 | MQUAD® |
| IC51-2724-1727 | 272 | 36 x 36 | 0.5 | 39.9 | 39.9 | 36.0 | 36.0 | 37.6 | 37.6 | Floating Base |
| IC51-3044-1471-2 | 304 | 40 x 40 | 0.5 | 42.6 | 42.6 | 40.0 | 40.0 | 41.6 | 41.6 | Lidless IC201-3044-004 |
| IC51-3044-1471-5 | 304 | 40 x 40 | 0.5 | 42.6 | 42.6 | 39.64 | 39.64 | 41.9 | 41.9 | MQUAD® |

FB = Floating Base

† = We have many variations of this product. Please contact our salespersons for further details.

This information is for reference only. We recommend actual check of package for any socket with a Floating Base before ordering.

MQUAD® is a Registered Trademark of Olin Corp.

For detailed drawings or information please contact our sales office at (408) 456-0797.

PC BOARD LAYOUTS

QFP, PQFP, TQFP (Clamshell)

IC51 Series

IC51-0324-805 (32 Pins)

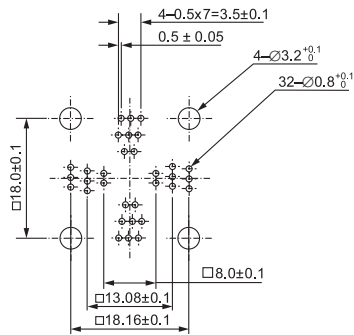

IC51-0324-1498 (32 Pins)

IC51-0324-354 (32 Pins)

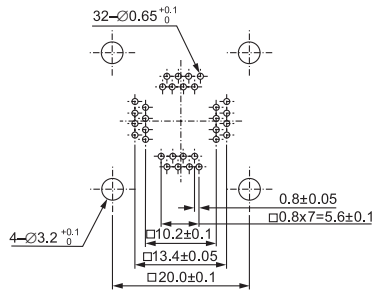

IC51-0444-1195-3 (44 Pins)

IC51-0444-825 (44 Pins)

IC51-467-KS11247 (44 Pins)

IC51-467-KS11787 (44 Pins)

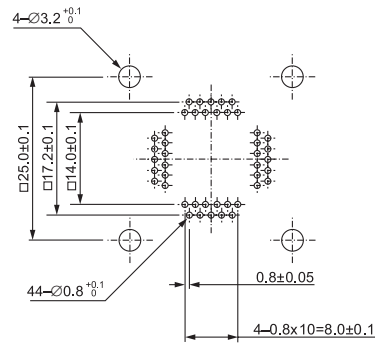

Quad Flat Packages

QFP, PQFP, TQFP (Clamshell)

PC BOARD LAYOUTS

IC51 Series

IC51-0444-798 (44 Pins)

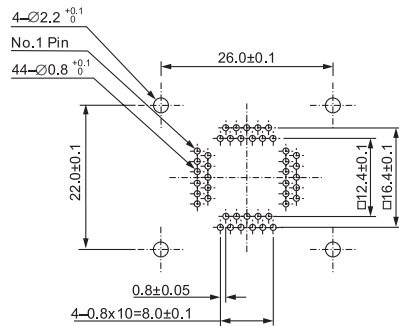

IC51-0484-806 (48 Pins)

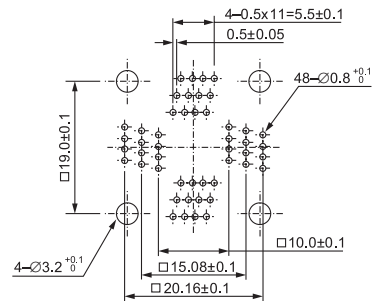

IC51-0444-615 (44 Pins)

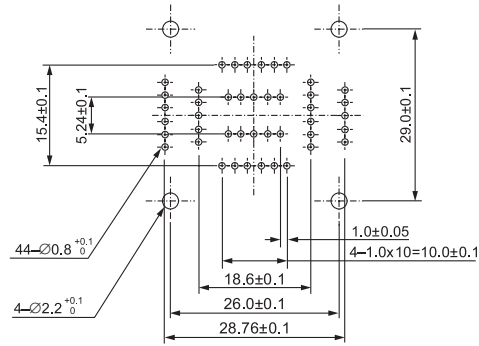

PC BOARD LAYOUTS

QFP, PQFP, TQFP (Clamshell)

IC51 Series

IC51-0484-081 (48 Pins)

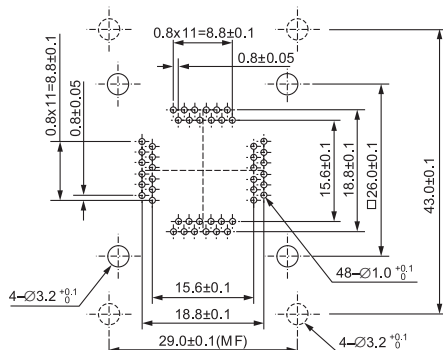

IC51-0564-924 (56 Pins)

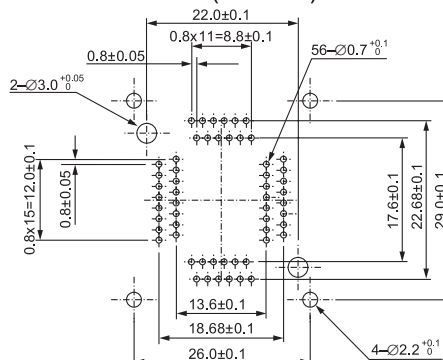

IC51-0564-680 (56 Pins)

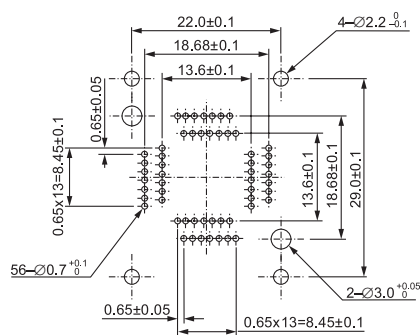

IC51-0564-790 (56 Pins)

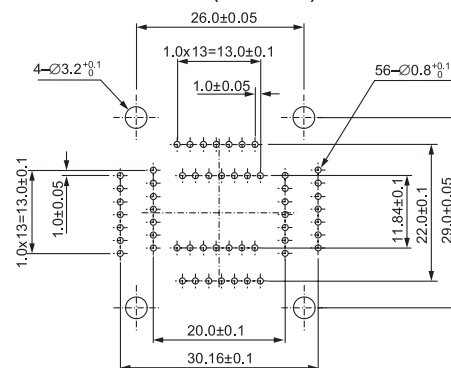

Quad Flat Packages

QFP, PQFP, TQFP (Clamshell)

IC51 Series

PC BOARD LAYOUTS

IC51-1004-809 (100 Pins)

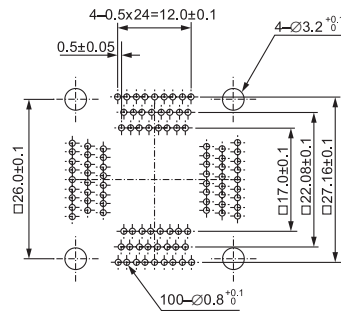

IC51-1004-567 (100 Pins)

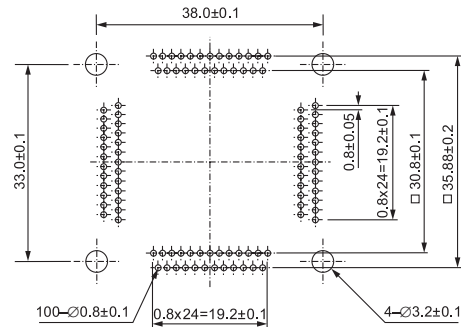

IC51-1124-1036-2 (112 Pins)

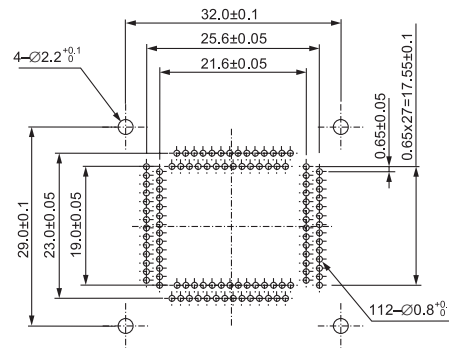

IC51-1004-814-1 (100 Pins)

IC51-1004-814-2 (100 Pins)

IC51-1004-814-13 (100 Pins)

IC51-814-KS12033 (100 Pins)

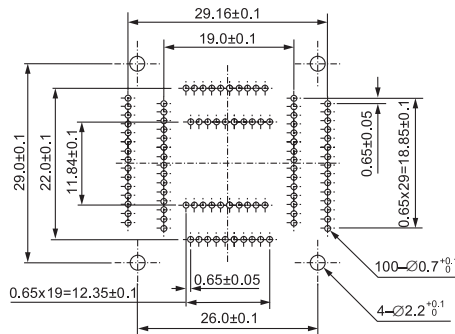

IC51-1204-1812 (120 Pins)

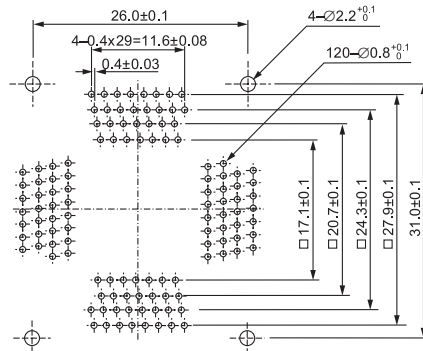

PC BOARD LAYOUTS

QFP, PQFP, TQFP (Clamshell)

IC51 Series

IC51-0644-692 (64 Pins)

IC51-0644-824-1 (64 Pins)

IC51-0644-824-2 (64 Pins)

IC51-0644-824-3 (64 Pins)

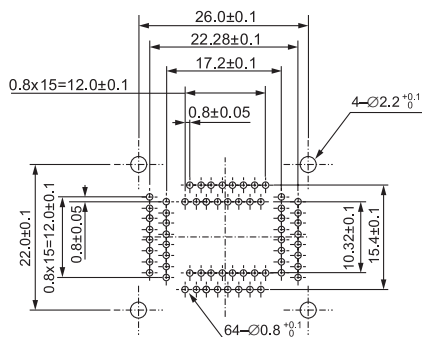

IC51-0684-734 (68 Pins)

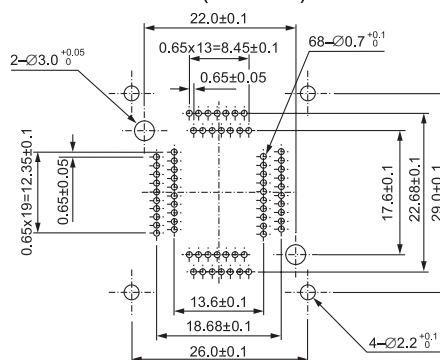

IC51-0644-472 (64 Pins)

IC51-0644-820-1 (64 Pins)

IC51-0644-820-2 (64 Pins)

IC51-0644-820-4 (64 Pins)

IC51-820-2-KS9376 (64 Pins)

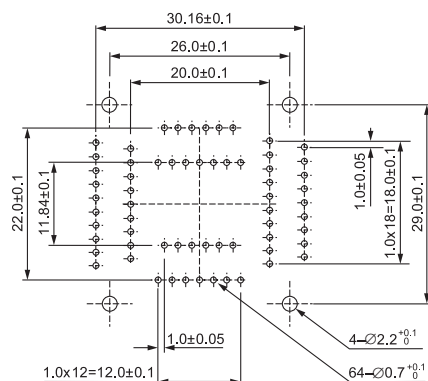

IC51-0724-698 (72 Pins)

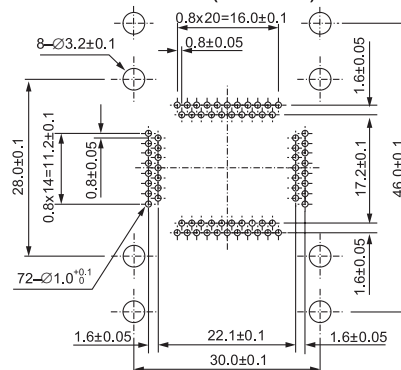

Quad Flat
Packages

QFP, PQFP, TQFP (Clamshell)

IC51 Series

PC BOARD LAYOUTS

IC51-0804-808 (80 Pins)

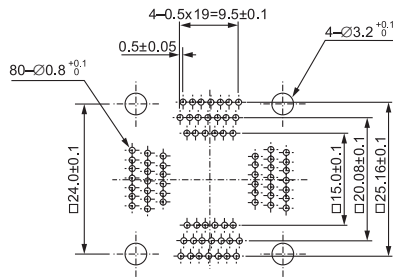

IC51-0804-795 (80 Pins)

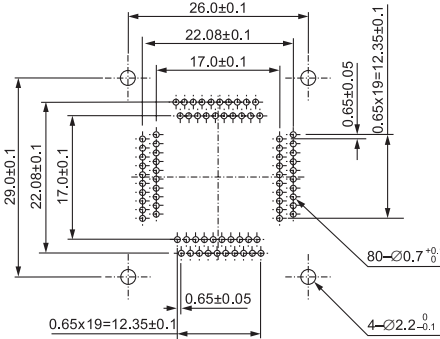

IC51-0804-711 (80 Pins)

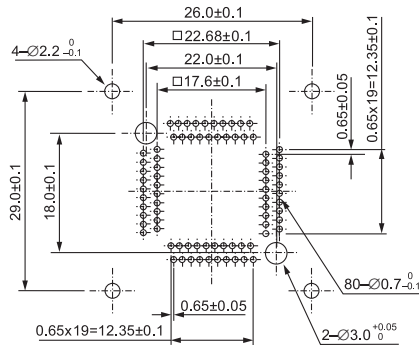

IC51-0804-819-1 (80 Pins)

IC51-0804-819-2 (80 Pins)

IC51-0804-819-8 (80 Pins)

IC51-819-KS12720 (80 Pins)

IC51-0804-956-2 (80 Pins)

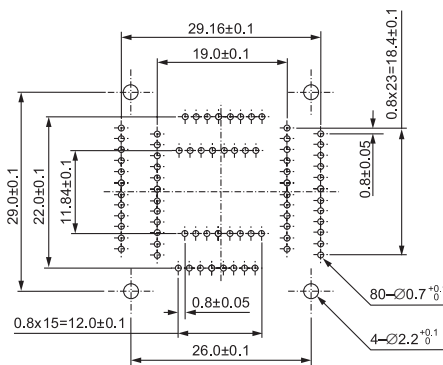
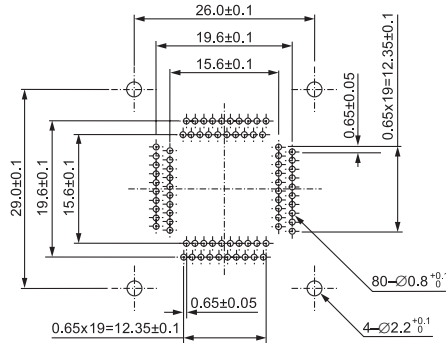

PC BOARD LAYOUTS

QFP, PQFP, TQFP (Clamshell)

IC51 Series

Quad Flat
Packages

IC51 Series

IC51-1204-1652 (120 Pins)

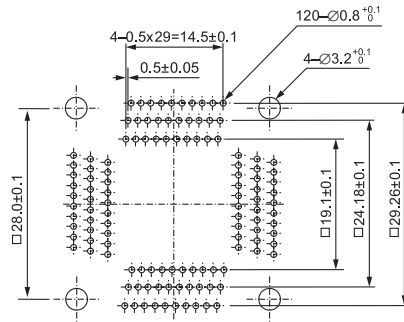

IC51-1284-1433 (128 Pins)
IC51-1284-1433-10 (128 Pins)

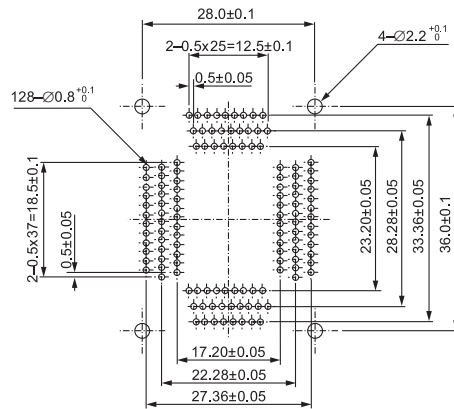

IC51-1497-KS11444 (120 Pins)
IC51-1204-1497 (120 Pins)

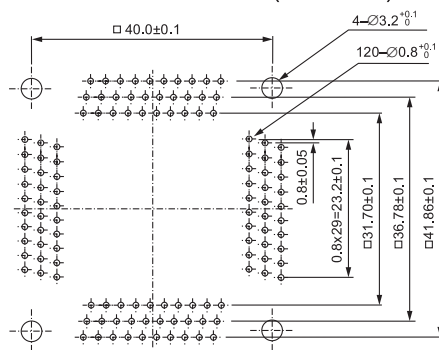

IC51-1284-844-1 (128 Pins)
IC51-1284-976-1 (128 Pins)
IC51-1284-976-2 (128 Pins)
IC51-844-KS13329 (128 Pins)

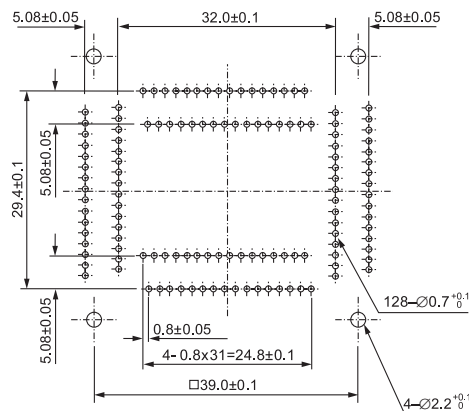

PC BOARD LAYOUTS

QFP, PQFP, TQFP (Clamshell)

IC51 Series

IC51-1444-1354 (144 Pins)

IC51-1444-1354-7 (144 Pins)

IC51-1354-KS11590 (144 Pins)

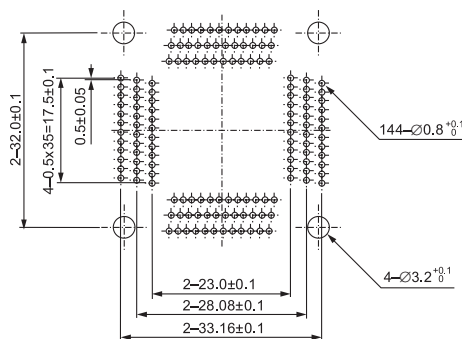

IC51-1604-1350 (160 Pins)

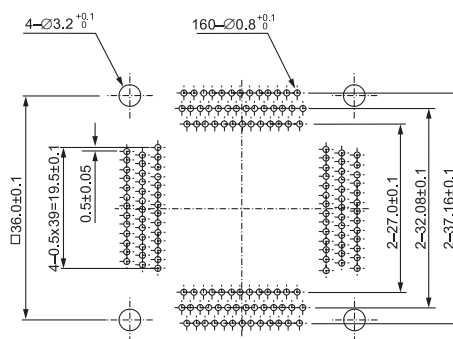

IC51-1444-1014 (144 Pins)

IC51-1444-1014-3 (144 Pins)

IC51-1014-KS11137 (144 Pins)

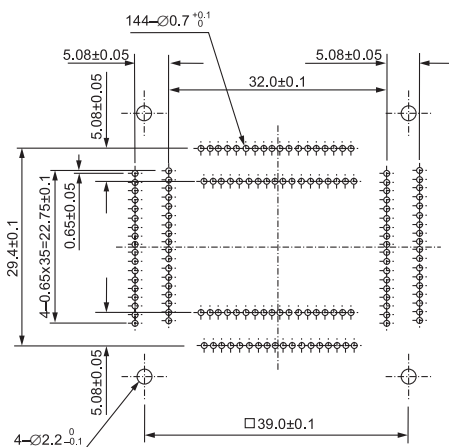

IC51-1604-845-1 (160 Pins)

IC51-1604-845-4 (160 Pins)

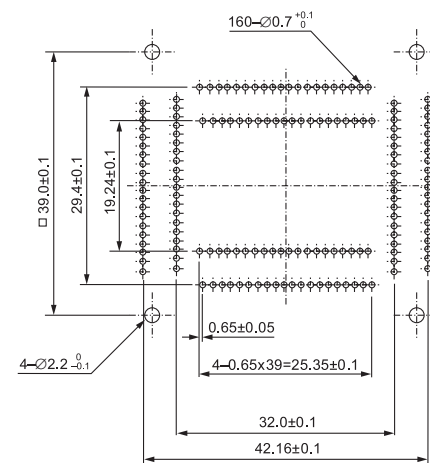

Quad Flat Packages

IC51 Series

PC BOARD LAYOUTS

IC51-1764-1505 (176 Pins)

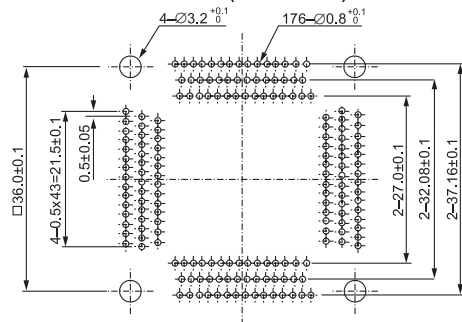

IC51-2084-1052-*¹⁾ (208 Pins)
IC51-2084-1509 (208 Pins)

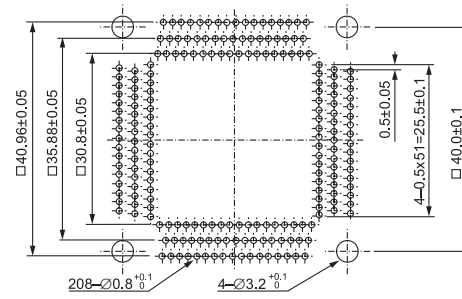

*¹⁾ for type: -1, -2, -3, -5, -6, -7, -9 and -11

IC51-1844-1148-1 (184 Pins)

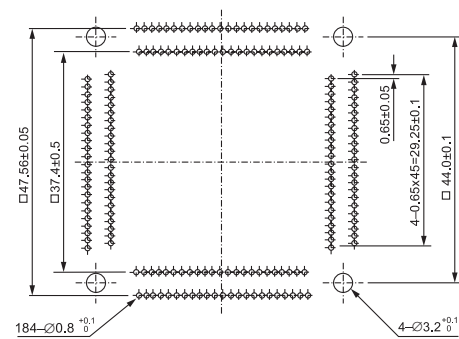

IC51-2084-1052-*²⁾ (208 Pins)

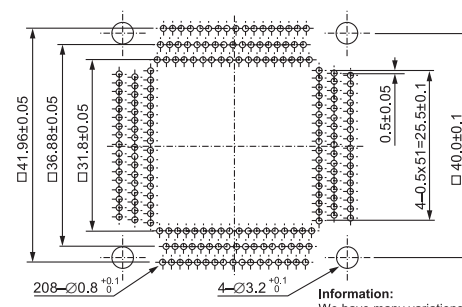

*²⁾ for type: -4, -8 and -13

Information:
We have many variations of this product. Please contact our sales staff for further details.

IC51-1844-1541 (184 Pins)

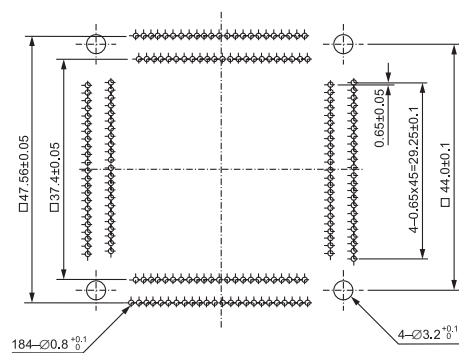

IC51-2404-1655-2 (240 Pins)
IC51-2404-1655-3 (240 Pins)

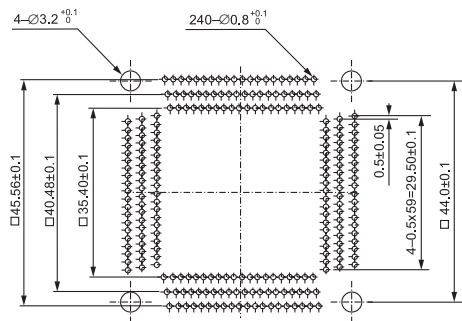

PC BOARD LAYOUTS

QFP, PQFP, TQFP (Clamshell)

IC51 Series

IC51-2564-1668 (256 Pins)

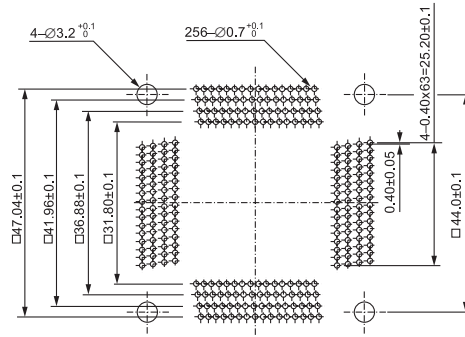

IC51-2724-1727 (272 Pins)

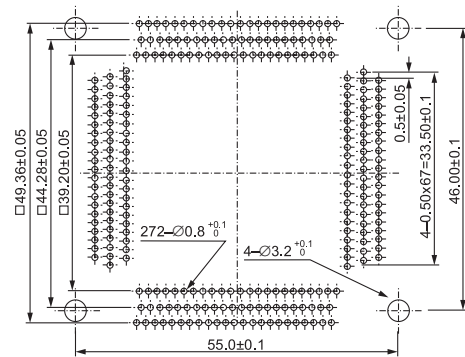

IC51-3044-1471-2 (304 Pins)

IC51-3044-1471-5 (304 Pins)

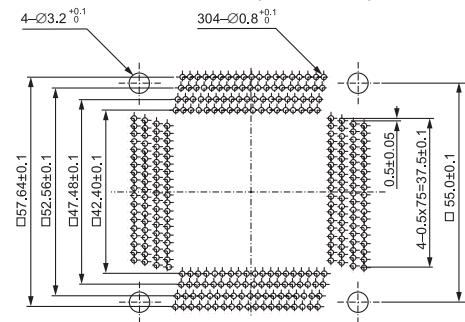

Quad Flat Packages