

Elma TT

Logistik GmbH

Raiffeisenstrasse 4
89415 Lauingen
Telefon: 09072/ 991956
Telefax: 09072/ 991963
e-mail: elmatt@ t-online.de

Constructional data for isolating transformers and safety transformers:

- 1.1 Applicant : ELMA TT d.d. Ljubljana
- 1.2 Place of manufacture : Cesta 24. junija 23, SLO 1213 Ljubljana – Črnuče
- 1.3 Reference of type : PV/0-23040
- 1.4 Trade mark : CONRAD
- 1.5 Other markings : IZ3181 - Conrad Art. Nr. 408210
- 1.6 Europe standard : EN 61558 - 2 - 4

- 2.1 Protection against electric shock : Non short.circuit proof
- 2.2 Class of protection to IEC 529 : IP 00
- 2.3 Type of construction (Isolating transformer) : Isolating transformer
- 2.4 Stationary Transformer : Stationary, to built-in transformer
Portable Transformer :
- 2.5 Protection against short-circuit according to Sub-clause
inherently short-circuit proof :
non-inherently short-circuit proof :
non short-circuit proof : Non short-circuit proof
fail safe
(rated current of the cutout)
- 2.6 Rated maximum ambient temperature : ta 40 °C
- 2.7 Class : B Insulation : IEC 60 085 and IEC 60 216

3. Electrical values

		prim :	sec:
3.1 Rated voltage(s)	V :	230-400	230
3.2 Rated frequency	Hz :	50	
3.3 Rated current	A :	0,8-0,47	0,7
3.4 Rated output	VA :		160

4. Windings

4.1 Coil base,	number :	1
	material :	Duretan AKV 30 H – PA 6.6
4.2 Material of layer insulation :		Film poliestere 0.13 , classe B-130 - Teflex
4.3 Windings,	number :	660+485 729
	material :	Enoflex G1 – S180 Enoflex G1 – S180
4.4 Diameter of wire (mm) :		0,5+0,355 0,5
4.5 Windings insulation, material :		polyurethane polyamide polyurethane polyamide

5. Iron core

5.1 Sheet metall, material :	EI 96 V 530 – 50
	main dimensions : 96x80x35
5.2 Cross-sectional drawing :	See specification of insulation materials

6. Type of construction

6.1 Open – Covered – In case protection :	Open
6.2 Impregnated – Undrowned – Drowned :	Impregnated
6.3 Soaking (liquor) :	
6.4 Underpressure – Overpressure – Soaking at :	Soaking
6.5 Drown material :	1K – Traenharz E8561 Blaugrau Herberts

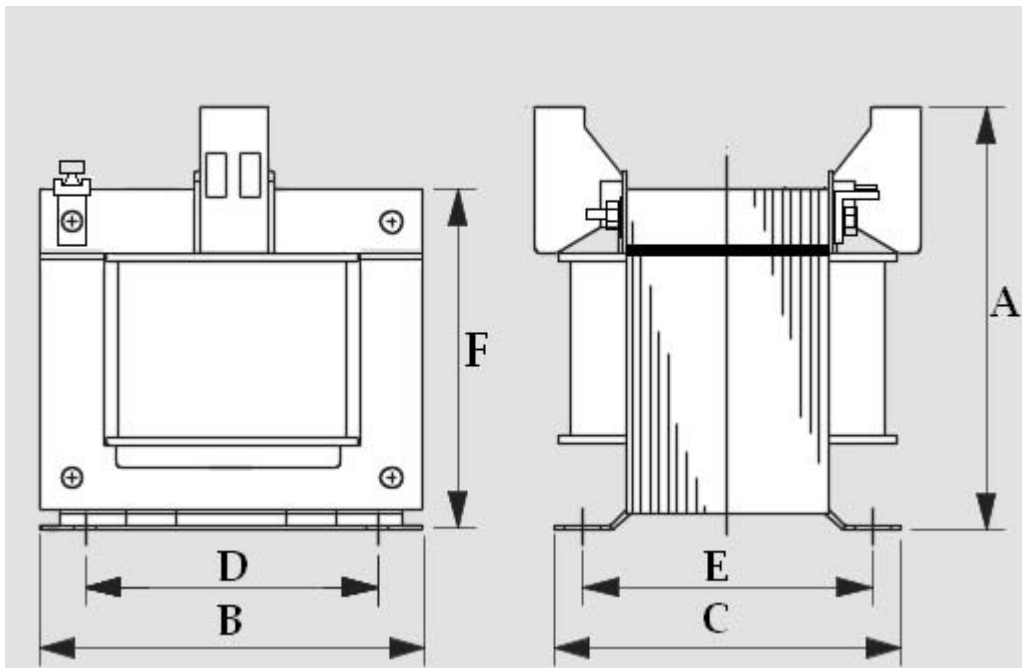

A(mm)	B(mm)	C(mm)	D(mm)	E(mm)	F(mm)	Weight (kg)
103	96	81	84	65,3	80	2,4