

HRTR 2 Miniature diffuse reflection light scanner with background suppression

en 03-2012/08 50112211



15mm (fixed)
30mm (fixed)
50mm (fixed)



- Miniature diffuse reflection light scanner with visible red light
- Homogenous, focussed light beam with a very small, laser-like light spot
- Very good background suppression
- 3 permanently set scanning ranges: 15 mm, 30 mm or 50 mm
- Miniature construction with temperature-stable plastic housing with protection class IP 67 and 2 inlaid metal fastening sleeves for secure mounting

Dimensioned drawing

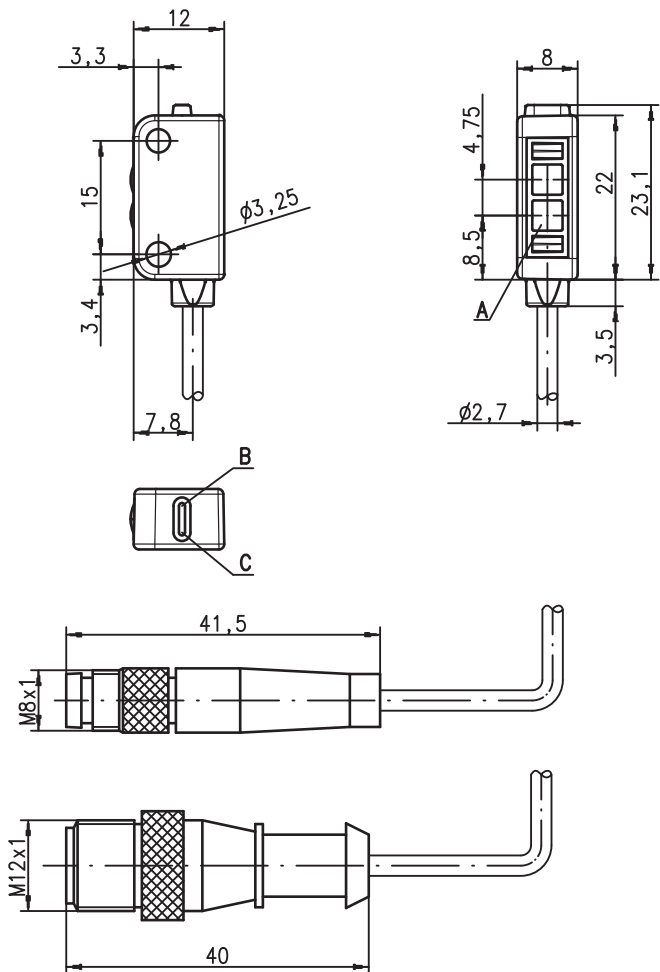

- A** Transmitter
- B** Yellow indicator diode
- C** Green indicator diode

Electrical connection

Plug connection, 4-pin

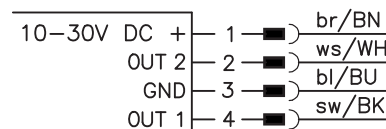

Cable, 4 wires

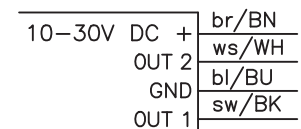

Plug connection, 3-pin

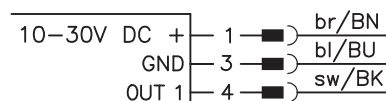

We reserve the right to make changes • DS_HRTR2_en_50112211.fm

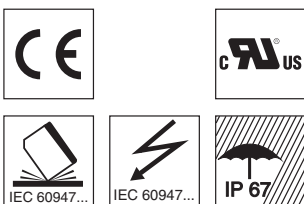

Accessories:

(available separately)

- Mounting device BT 002 M.5 (50112206)
- Cable with M8 or M12 connector (K-D ...)

Specifications

Optical data

Typ. scanning range limit ¹⁾
 Scanning range ²⁾
 Light beam characteristic
 Light spot at focal point
 Light source³⁾
 Wavelength

HRTR 2...-15F...	HRTR 2...-30F...	HRTR 2...-50F...
15mm	30mm	50mm
see tables	focussed at 16mm	focussed at 16mm
focussed at 10mm	focussed at 16mm	focussed at 16mm
typ. < 1mm		
LED (modulated light)		
640nm (visible red light)		

Timing

Switching frequency 700Hz
 Response time 0.72ms
 Repeatability 175µs
 Delay before start-up ≤ 120ms

Electrical data

Operating voltage U_B ⁴⁾ 10 ... 30VDC (incl. residual ripple)
 Residual ripple ≤ 10% of U_B
 Open-circuit current ≤ 20mA
 Switching output .../42

OUT1 (pin 4): PNP light switching
 OUT2 (pin 2): NPN light switching
 .../42D OUT1 (Pin 4): PNP dark switching
 OUT2 (Pin 2): NPN dark switching
 .../2 OUT1 (pin 4): NPN light switching
 bipolar transistor with open collector,
 leakage current (OFF):
 PNP=10µA, NPN=200µA,
 saturation voltage (ON, at 50mA):
 PNP=1.45V, NPN=1.25V
 max. 50mA (per output and total)
 C ≤ 2.2µF

Output configuration

Output current Load

Indicators

Green LED in continuous light ready
 Green LED, flashing output overloaded
 Yellow LED in continuous light object detected - reflection
 Yellow LED, flashing object detected - reflection, performance reserve too low

Mechanical data

Housing plastic (TPE), color: red RAL 3000
 Optics cover plastic (PC)
 Fastening by means of 2 brass sleeves integrated in the housing
 Weight with 2m cable: 50g
 with 150mm cable and connector: 20g
 Connection type 2m cable, PVC, 4-wire, core cross section 4x0.14mm²,
 150mm cable with M8/M12 connector, 4-pin,
 150mm cable with M8/M12 connector, 3-pin

Environmental data

Ambient temp. (operation/storage) -20°C ... +55°C/-30°C ... +75°C
 Protective circuit ⁵⁾ 1, 2, 3, 4
 VDE safety class III
 Protection class IP 67
 LED class 1 (in accordance with EN 60825-1)
 Standards applied IEC 60947-5-2
 Certifications cURus (Recognised Component Mark for Canada and USA)

- 1) Typ. scan. range limit: max. achievable scanning range for light objects (white 90%)
- 2) Scanning range: recommended scanning range for objects with different diffuse reflection
- 3) Average life expectancy 100,000h at an ambient temperature of 25°C
- 4) For UL applications: for use in class 2 circuits according to NEC only
- 5) 1=overload protection, 2=polarity reversal protection, 3=short circuit protection for all transistor outputs, 4=transient protection max. ± 50V

Remarks

● Approved purpose

The diffuse reflection light scanners are optical electronic sensors for optical, contactless detection of objects. This product may only be used by qualified personnel and must only be used for the approved purpose. This sensor is not a safety sensor and is not to be used for the protection of persons.

Tables

HRTR 2...-15F...

	mm					
1	1	4		14	18	
2	OFF	3	5	Scanning range [mm]	12	17
3		4	7		10	16

HRTR 2...-30F...

	mm					
1	1	5		28	35	
2	OFF	3	6	Scanning range [mm]	24	33
3		4	7		20	32

HRTR 2...-50F...

	mm					
1	1	4		46	60	
2	OFF	3	6	Scanning range [mm]	34	52
3		4	8		24	45

1	white 90%
2	grey 18%
3	black 6%

Scanning range [mm]
 Typ. scanning range limit [mm]
 Sensor OFF



In the areas between "Sensor OFF" and the operating range, the sensor functions with only a low performance reserve. The sensor typically flashes in this case. Depending on the tolerance, it is, however, also possible that the sensor no longer detects objects.

Diagrams

HRTR 2...-15F...

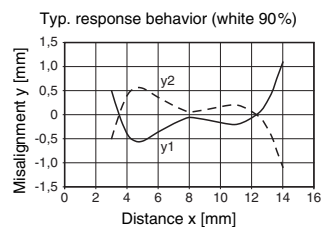

HRTR 2...-30F...

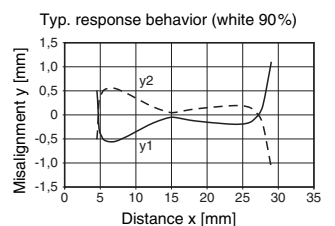

HRTR 2...-50F...

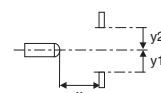
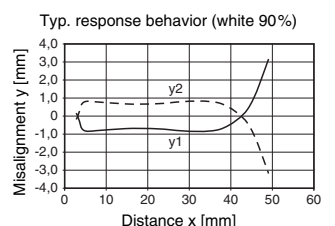

HRTR 2 Miniature diffuse reflection light scanner with background suppression

Part number code

H	R	T	R	2	/	4	2	D	-	1	5	F	,	1	5	0	-	S	1	2
---	---	---	---	---	---	---	---	---	---	---	---	---	---	---	---	---	---	---	---	---

Operating principle

HRTR	Miniature light scanners with background suppression, red light
PRK	Miniature retro-reflective photoelectric sensor with polarization filter
LSSR	Miniature throughbeam photoelectric sensor, red-light transmitter
LSER	Miniature throughbeam photoelectric sensor, red-light receiver

Series

2	2 Series
----------	----------

Switching output

/42	Bipolar transistor output open collector, OUT 1 (pin 4): PNP, OUT 2 (pin 2): NPN
------------	--

Switching output function

N/A	OUT 1 and OUT 2 both light switching
D	OUT 1 and OUT 2 both dark switching

Scanning range (only with operating principle HRTR)

-15F	Scanning range limit set to 15mm
-30F	Scanning range limit set to 30mm
-50F	Scanning range limit set to 50mm

Electrical connection

N/A	Cable, PVC, standard length 2000mm, 4-wire
,150-S8	Cable, PVC, length 150mm with M8 connector, 4-pin, axial
,150-S12	Cable, PVC, length 150mm with M12 connector, 4-pin, axial
,150-S8.3	Cable, PVC, length 150mm with M8 connector, 3-pin, axial

Order guide

The sensors listed here are preferred types; current information at www.leuze.com

Order code

Part no.

Scanning range permanently set to 15mm

HRTR 2/42-15F	50112109
HRTR 2/42-15F, 150-S8	50112110
HRTR 2/42-15F, 150-S12	50112111
HRTR 2/42D-15F	50112112
HRTR 2/42D-15F, 150-S8	50112113
HRTR 2/42D-15F, 150-S12	50112114

Scanning range permanently set to 30mm

HRTR 2/42-30F	50112115
HRTR 2/42-30F, 150-S8	50112116
HRTR 2/42-30F, 150-S12	50112117
HRTR 2/42D-30F	50112118
HRTR 2/42D-30F, 150-S8	50112119
HRTR 2/42D-30F, 150-S12	50112120

Scanning range permanently set to 50mm

HRTR 2/42-50F	50112121
HRTR 2/42-50F, 150-S8	50112122
HRTR 2/2-50F, 150-S8.3	50120855
HRTR 2/42-50F, 150-S12	50112123
HRTR 2/42D-50F	50112124
HRTR 2/42D-50F, 150-S8	50112125
HRTR 2/42D-50F, 150-S12	50112126

Application notes

- When detecting glossy surfaces (e.g. metals), the light beam should not be incident on the object surface at a right angle. A slight inclination is sufficient for preventing undesired direct reflections. The following rule of thumb applies: the smaller the scanning range, the larger the angle of inclination (approx. $5^\circ \dots 7^\circ$).

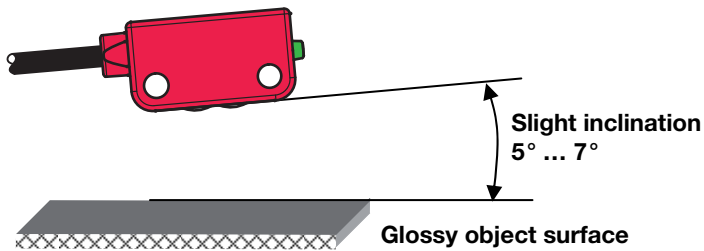

- Objects should only be moved in laterally from the right or left. Moving in objects from the cable side or LED side is to be avoided.
- The sensors are equipped with effective measures for the maximum avoidance of mutual interference should they be mounted opposite one another. Opposite mounting of multiple sensors of the same type should, however, absolutely be avoided.