





FRONT MOUNTED ROTARY OPERATOR EMERGENCY-OFF IEC  
IP30/40 ACCESSORY FOR 3VA5 125



Model	
Product brand name	SETRON
Product designation	Accessories
Design of the product	Front rotary operating mechanism
accessories	FRONT ROTARY OPERATING MECHANISM
General technical data	
Degree of protection NEMA rating	NEMA 1/3R/12
Mechanical Design	
Height	70 mm
Width	77 mm
Depth	95 mm
Certificates	

General Product Approval	EMC	Declaration of Conformity	other
 CSA	 UL	 EAC	 RCM
			 EG-Konf.
			<a href="#">Miscellaneous</a>

#### Further information

**Information- and Downloadcenter (Catalogs, Brochures,...)**

<http://www.siemens.com/lowvoltage/catalogs>

**Industry Mall (Online ordering system)**

<https://mall.industry.siemens.com/mall/en/en/Catalog/product?mlfb=3VA9137-0EK15>

**Service&Support (Manuals, Certificates, Characteristics, FAQs,...)**

<https://support.industry.siemens.com/cs/ww/en/ps/3VA9137-0EK15>

**Image database (product images, 2D dimension drawings, 3D models, device circuit diagrams, ...)**

[http://www.automation.siemens.com/bilddb/cax\\_en.aspx?mlfb=3VA9137-0EK15](http://www.automation.siemens.com/bilddb/cax_en.aspx?mlfb=3VA9137-0EK15)

**CAX-Online-Generator**

<http://www.siemens.com/cax>

**Tender specifications**

<http://www.siemens.com/specifications>

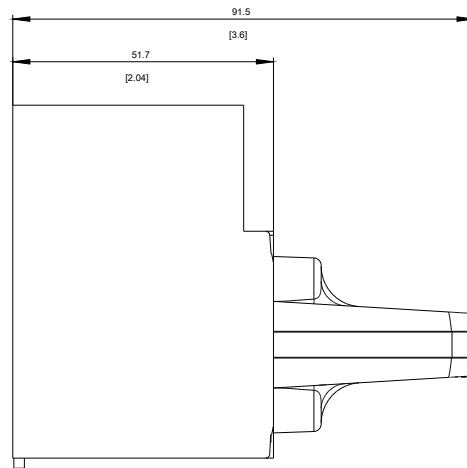
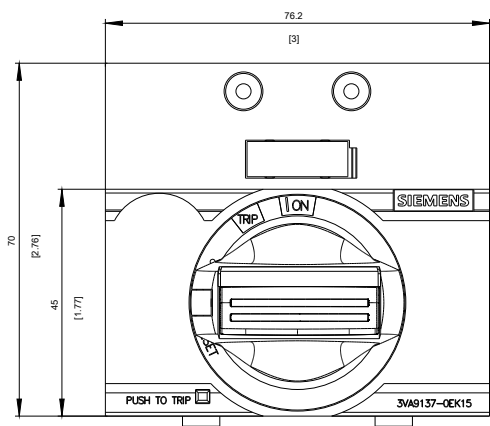

**last modified:**

08/28/2017