

# ENC09A

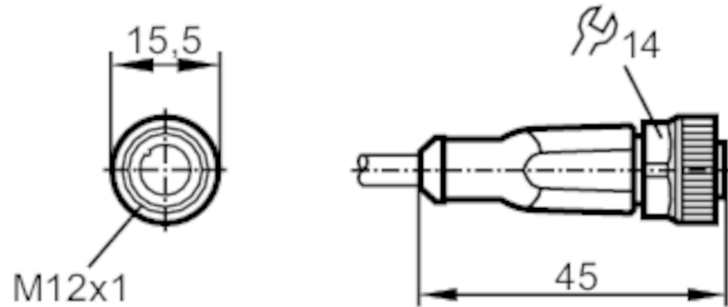

## Connecting cable with socket

ADOGH050MSN0010H05/1G/1D



### Application

Special feature	Free from silicone; Halogen-free; Gold-plated contacts
Free from silicone	yes
Compatible with paint	yes

### Electrical data

Operating voltage [V]	< 30 DC
Protection class	II
Max. input power [mW]	group II: 1000; group IIIB: 1000; group IIIC: 550 (Ta < 90 °C) / 650 (Ta < 70 °C) / 750 (Ta < 40 °C)
Max. current load total [A]	1

### Operating conditions

Ambient temperature [°C]	-25...90
Note on ambient temperature	for use in hazardous areas: ambient temperature in accordance with unit marking
Protection	IP 67; (outside hazardous areas: IP 68 / IP 69K)

### Tests / approvals

Approval	BVS 11 ATEX E 009 X; IECEx BVS 11.0002 X
ATEX marking	⊕ II 1G Ex ia IIB T6 Ga Ta: -25...80°C
	⊕ II 2G Ex ia IIC T6 Gb Ta: -25...80°C
	⊕ II 1D Ex ia IIIC T85°C Da Ta: -25...80°C
	⊕ II 1G Ex ia IIB T5 Ga Ta: -25...90°C
	⊕ II 2G Ex ia IIC T5 Gb Ta: -25...90°C
	⊕ II 1D Ex ia IIIC T95°C Da Ta: -25...90°C

# ENC09A



## Connecting cable with socket

ADOGH050MSN0010H05/1G/1D

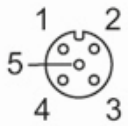
Safety classification	
Max. internal capacitance [nF]	1
Max. internal inductance [ $\mu$ H]	20
Mechanical data	
Weight [g]	373.7
Dimensions [mm]	15.5 x 15.5 x 45
Materials	housing: TPU orange; Sealing: FKM
Material nut	brass, nickel-plated
Remarks	
Remarks	Special conditions for safe operation apply for use in hazardous areas. Observe the corresponding notes in the operating instructions (Ex protection related part).
Pack quantity	1 pcs.
Electrical connection	
Cable: 10 m, PUR, Halogen-free, blue, $\varnothing$ 4.9 mm; 5 x 0.34 mm <sup>2</sup> (42 x $\varnothing$ 0.1 mm )	
Electrical connection - socket	
Connector: 1 x M12, straight; Locking: brass, nickel-plated; Contacts: gold-plated; Tightening torque: 0.6...1.5 Nm	
	

# ENC09A



## Connecting cable with socket

ADOGH050MSN0010H05/1G/1D

### Connection

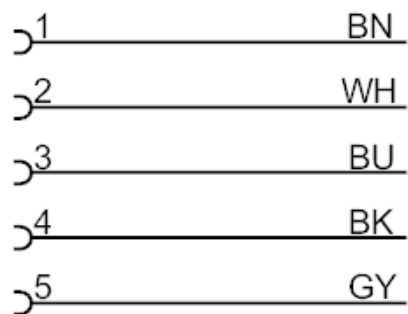

#### Core colours :

BK =	black
BN =	brown
BU =	blue
GY =	grey
WH =	white