

MTS 1-PHASE SAFETY TRANSFORMER

P: 250VA IN: 230/400VAC +/- 15VAC OUT: 24VAC

Single-phase safety transformer
250 VA
Isolation class T 40/B

Other voltages on request.

[Link to Product](#)

Illustration

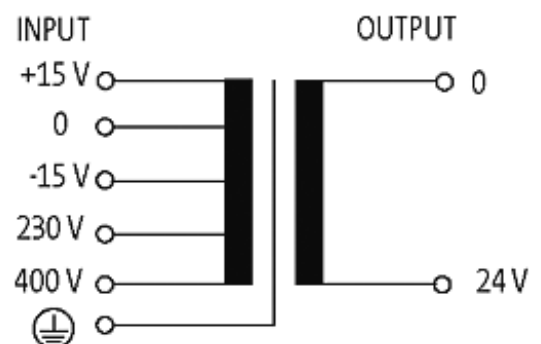

stay connected

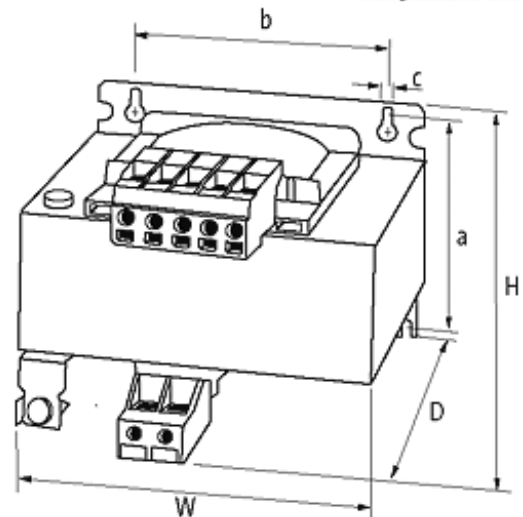

Product may differ from Image

Approvals



Input

Input voltage	230/400 ±15 V AC
Frequency	50...60 Hz
Input current	1.35 A (230 V AC); 0.78 A (400 V AC)
Inrush current	11.2 A (230 V AC); 6.45 A (400 V AC)
Short-circuit current	18.7 A (230 V AC); 10.7 A (400 V AC)

General data

Standards	(EN 61558-1), (EN 61558-2-6), (EN 62041 category 0)
Test isolation voltage	4 kV (prim./sec.)
Mounting method	Long-hole mounting or DIN-rail mountable TH35 (EN 60715)
Temperature range	-20...+40 °C, no condensation
Dimensions H × W × D	102×96×108 mm
Fixing centers a × b × c	86.5×84×4.8 mm
Drill hole Ø	4.8×8.4 mm

Output

Output voltage	24 V AC (SELV)
----------------	----------------

Commercial data

country of origin	CZ
customs tariff number	85043180
minimum order quantity	1