

Thumb Knobs
24520.0002



Product Description

Material

- Steel, blackened

Drawing

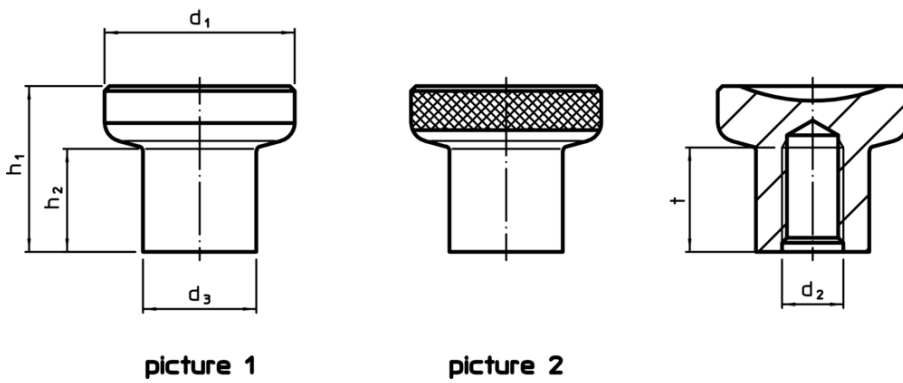

Order information

Dimensions							Art. No.
d ₁	d ₂	d ₃	h ₁	h ₂	t min.	[g]	
without knurling – picture 1, steel							
21	M4	12.5	18	10.5	10	26	24520.0002

Application example

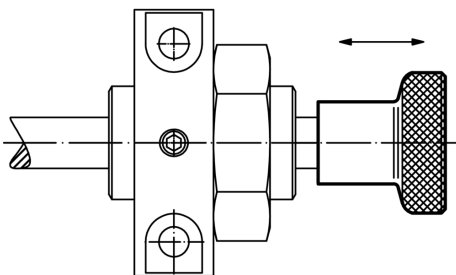

Compliance

RoHS compliant

Contains lead - compliant according to exceptions 6a / 6b / 6c

Contains SVHC substances >0,1% w/w

Contains lead - SVHC list [REACH] as of 10.06.2022

Contains Proposition 65 substances



Lead can cause cancer and reproductive harm from exposure

<https://www.P65Warnings.ca.gov/>

Free from Conflict Minerals

This product does not contain any substances designated as "conflict minerals" such as tantalum, tin, gold or tungsten from the Democratic Republic of Congo or adjacent countries.