

Accessories Miniature Relay PT

- Easy replacement of relays on a densely packed DIN rail
- No reduction of protection class or creepage/clearance with plastic retainer
- Plug-in indicator- and protection modules
- Retainer clip with ejection function for relays of 29 mm height

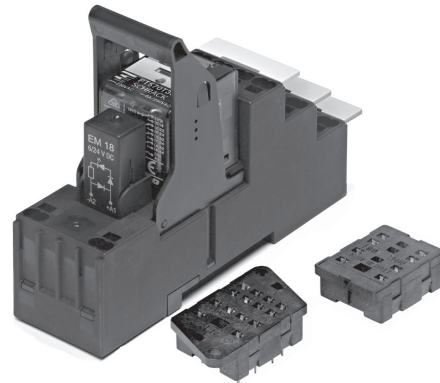

F0263-F

Premium socket with screwless terminals for DIN rail mounting

PT 78 74P Premium socket, logical terminal arrangement, 4 pole
PT 78 72P Premium socket, logical terminal arrangement, 2 pole

- PT 2/4 pole 12/6 A
- Screwless Clamps
- Mounting of solid wires without tool
- Double Clamps per terminal
- Jumper links for interconnection
- Open coil circuit for active modules
- Logical terminal arrangement

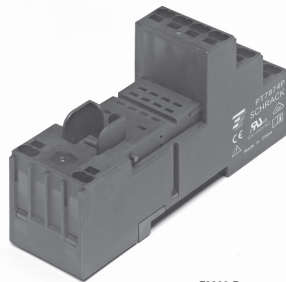

F0300-B

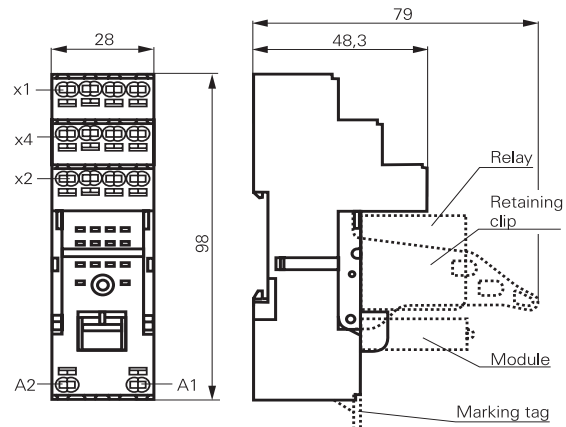

S0546-AE

Approvals
 VDE Cert. No. 40009108, cULus E135149

Technical data	2-pole	4-pole
Rated voltage/Max. switching voltage AC	240/400VAC	240 VAC
Rated current	12 A	6 A
Limiting continuous current	see derating curve	
Dielectric strength		
coil contact circuit	2500 V _{rms}	2500 V _{rms}
open contact circuit	1200 V _{rms}	1200 V _{rms}
adjacent contact circuits	2500 V _{rms}	2000 V _{rms}
Clearance / creepage		
coil contact circuit	≥ 4/4 mm	≥ 4/4 mm
adjacent contact circuits	≥ 3.5/9.5 mm	≥ 1.8/3.5 mm
Material group of insulation parts	IIIa	
Insulation to IEC 60664-1		
Type of insulation coil-contact circuit	basic	
open contact circuit	functional	
adjacent contact circuits	basic	
Rated insulation voltage	250 V	
Pollution degree	2 ¹⁾	
Rated voltage system	230 / 400 V	
Overvoltage category	III	

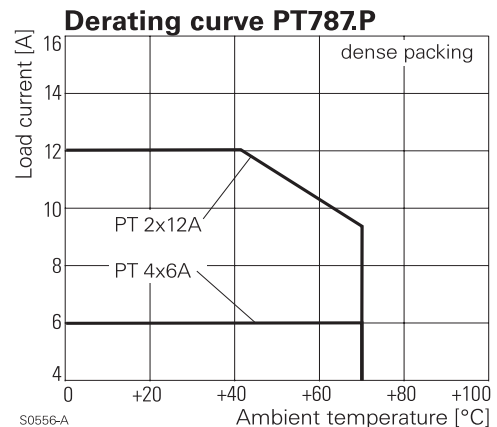

S0556-A

1) with inserted relay pollution degree 1 in region of contact pins / socket inlets.

Accessories Miniature Relay PT (Continued)

Technical data (continued)

Material compliance: EU RoHS/ELV, China RoHS, REACH, Halogen content refer to the Product Compliance Support Center at www.te.com/customersupport/rohssupportcenter

	2-pole	4-pole
Ambient temperature range for mounting/handling	-25...+70°C	
in operation	-40...+70°C	
Terminals	screwless	
Wire strip length	12 mm	
Wire cross section solid wire	1x0.75/1/1.5mm ²	2x0.75/1mm ²
with stand. isolation (no oversize isolation)	2x1.5mm ²	
stranded wire without bootlace crimp	1x0.75/1/1.5mm ²	2x0.75/1mm ²
without bootlace crimp with stand. isolation	2x1.5mm ²	
with bootlace crimp	1x0.75/1mm ²	2x0.75mm ²
with bootlace crimp without isolation or min 18 mm long	1x1.5mm ²	

For stranded wires with braids 0.05 mm or smaller the use of bootlace crimps is recommended. When using stranded wires without bootlace crimp the clamp must be opened during insertion.

Insertion cycles	A (10)	
Max. Insertion Force total	100 N	
Mounting distance	≥ 0, dense packing	
Weight	44 g	60 g
Packaging unit	10 pcs	

Socket with screwless terminals for DIN rail mounting

Type	Part Number
PT 7872P Premium socket, logical terminal arrangement Socket with screwless terminals 2 pole	1860100-1
PT 7874P Premium socket, logical terminal arrangement Socket with screwless terminals 4 pole	1860000-1

Accessories for PT 78 72P, PT 78 74P

Type	Part Number
PT 17 021 Plastic retaining clip, relay height 29 mm	2-1415526-1
PT 28 800 Metal retaining clip PT, relay height 29 mm	5-1419111-9
PT 17 040 Marking tag	6-1415037-1
PT 17 0P1 Jumper link, max load 12 A	1860214-1

How to use, Precautions

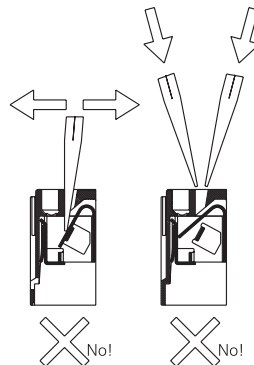
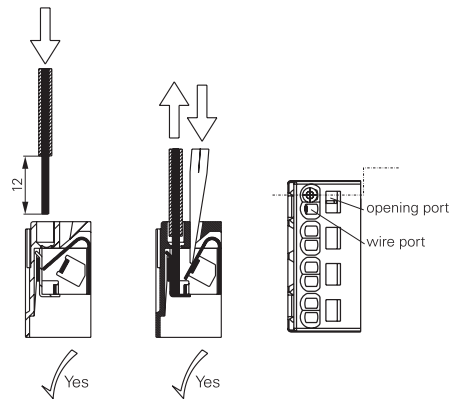
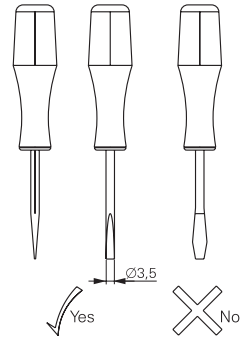

S0553-A

Jumper link

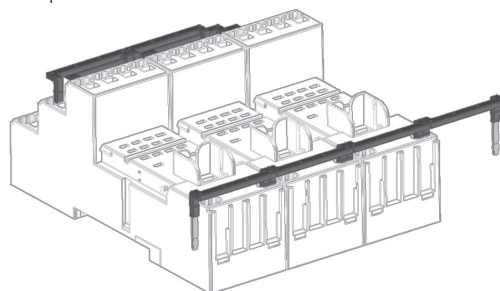

F0295-A

When connecting more than 2 poles with staggered jumper bars the lower bars need to be stripped and shortened to an appropriate length to enable correct fitting.

Accessories Miniature Relay PT (Continued)

**DIN-rail socket with screw type terminals
PT78722/PT78742**

- Socket with logical arrangement of control/load terminals
- High quality rising clamp terminals
- Captive combination terminal screws
- Second A2 for easier looping
- Jumper bars for interconnection

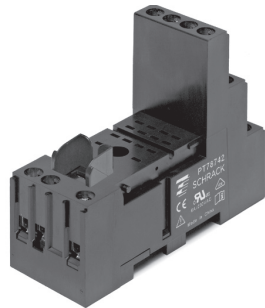

F0264-C

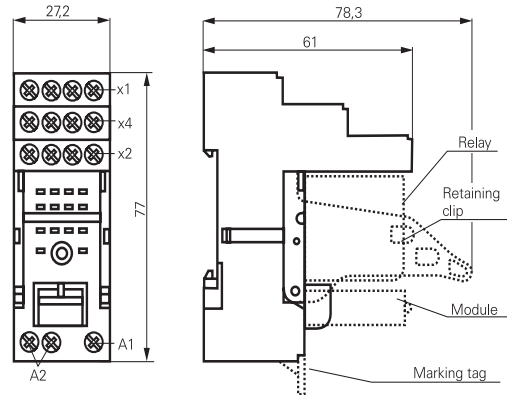

S0489-CA

Approvals

VDE Cert. No. 40009108, cULus E135149

Technical data	2-pole	4-pole
Rated voltage/Max. switching voltage AC	240/400VAC	240 VAC
Rated current	12 A	6 A
Limiting continuous current	see derating curve	
Dielectric strength		
coil contact circuit	2500 V _{rms}	2500 V _{rms}
open contact circuit	1200 V _{rms}	1200 V _{rms}
adjacent contact circuits	2500 V _{rms}	2000 V _{rms}
Clearance / creepage		
coil contact circuit	≥ 4/4 mm	≥ 4/4 mm
adjacent contact circuits	≥ 3.5/9.5 mm	≥ 1.8/3.5 mm
Material group of insulation parts	IIIa	
Insulation to IEC 60664-1		
Type of insulation coil-contact circuit	basic	
open contact circuit	functional	
adjacent contact circuits	basic	
Rated insulation voltage	250 V	
Pollution degree	2 ¹⁾	
Rated voltage system	230 / 400 V	
Overvoltage category	III	
Material compliance: EU RoHS/ELV, China RoHS, REACH, Halogen content refer to the Product Compliance Support Center at www.te.com/customersupport/rohssupportcenter		
Ambient temperature range	-40...+70°C	
Terminals	screw	
Terminals screw torque acc. IEC 61984	0.5 Nm	
max.	0.7 Nm	
Wire cross section		
single wire	2 x 2.5 mm ²	
fine wire	2 x 2.5 mm ²	
with bootlace crimp (DIN 46228/1)	2 x 1.5 mm ²	
Insertion cycles	A (10)	
Max. Insertion Force total	100 N	
Mounting distance	≥ 0, dense packing	
Weight	44 g	60 g
Packaging unit	10 pcs	

Derating curve

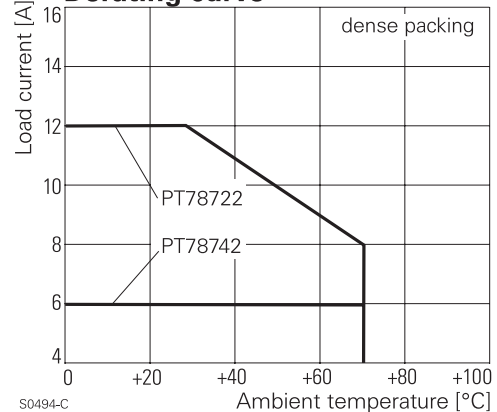

S0494-C

1) with inserted relay pollution degree 1 in region of contact pin/socket inlets

Accessories Miniature Relay PT (Continued)

DIN-rail socket with screw type terminals, In/Out arrangement

Type	Part Number
PT 78 722 DIN-rail socket with screw type terminals, In/Out arrangement 2 pole	1415526-1
PT 78 742 DIN-rail socket with screw type terminals, In/Out arrangement 4 pole	1-1415526-1

Accessories for PT 78 722, PT 78 742

Type	Part Number
PT 17 021 Plastic retaining clip, relay height 29 mm	2-1415526-1
PT 28 800 Metal retaining clip PT, relay height 29 mm	5-1419111-9
PT 17 040 Marking tag	6-1415037-1
PT 17 0R6 Jumper bar, max load 12A for connection of up to 6 PT sockets	1860517-5

Jumper bar

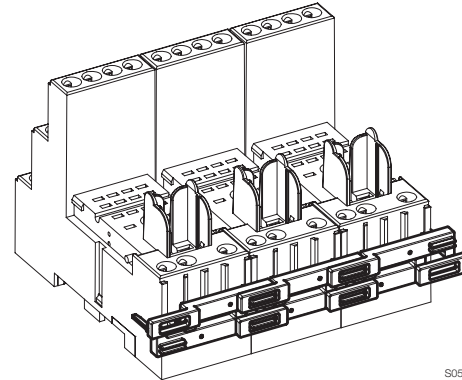

S0559-AP

PT DIN-rail socket with screw type terminals PT78720/730/740/741

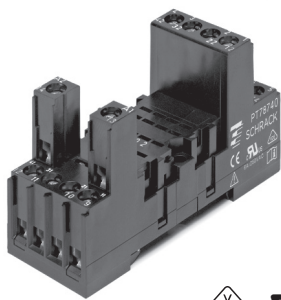

F0234-C

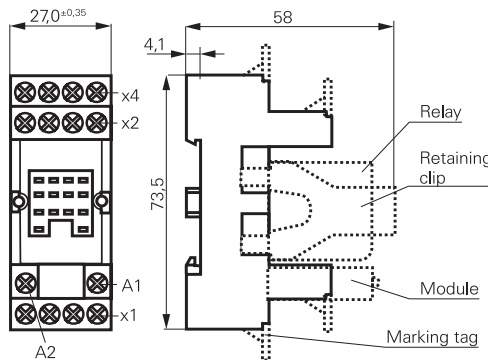

S0427-DB

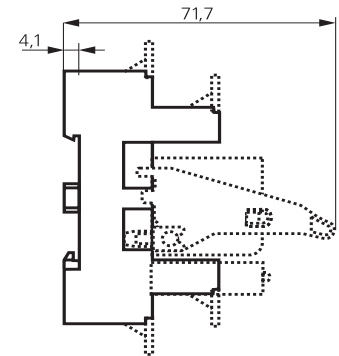

S0427-CF

Approvals

VDE Cert. No. 40009108, cULus E135149

Technical data	2-pole	3-pole	4-pole
Rated voltage/Max. switching voltage AC	240/400VAC		
Rated current	12 A	10 A	6 A
Limiting continuous current	see derating curve		
Dielectric strength			
coil-contact circuit	2500 V _{rms}	2500 V _{rms}	2500 V _{rms}
open contact circuit	1200 V _{rms}	1200 V _{rms}	1200 V _{rms}
adjacent contact circuits	2500 V _{rms}	2500 V _{rms}	2000 V _{rms}
Clearance / creepage			
coil-contact circuit	≥ 4/4 mm	≥ 4/4 mm	≥ 4/4 mm
adjacent contact circuits	≥3.5/9.5mm	≥2.6/3.5mm	≥1.8/3.5mm
Material group of insulation parts IIIa			
Insulation to IEC 60664-1			
Type of insulation			
coil-contact circuit	basic	basic	basic
open contact circuit	functional	functional	functional
adjacent contact circuits	basic	basic	functional
Rated insulation voltage	250 V		
Pollution degree	2		
Rated voltage system	230 / 400 V		
Overvoltage category	III		
Material compliance: EU RoHS/ELV, China RoHS, REACH, Halogen content refer to the Product Compliance Support Center at www.te.com/customer-support/rohssupportcenter			
Ambient temperature range	-40...+70°C		

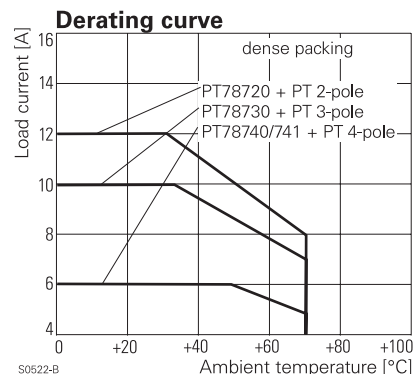

S0522-B

Accessories Miniature Relay PT (Continued)

Technical data (continued)	2-pole	3-pole	4-pole
Terminals		screw	
Terminal screw torque acc. IEC 61984		0.5 Nm	
max.		0.7 Nm	
Wire cross section			
single wire		2 x 2.5 mm ²	
fine wire		2 x 2.5 mm ²	
with bootlace crimp (DIN 46228/1)		2 x 1.5 mm ²	
Insertion cycles		A (10)	
Max. Insertion Force total		100 N	
Mounting distance		≥ 0, dense packing	
Weight	41 g	48 g	55 g
Packaging unit		10 pcs	

DIN-rail socket with screw type terminals		
Type		Part Number
PT 78 720	DIN-rail socket with screw type terminals, 2 pole	6-1415034-1
PT 78 730	DIN-rail socket with screw type terminals, 3 pole	9-1415071-1
PT 78 740	DIN-rail socket with screw type terminals, 4 pole	4-1415033-1
PT 78 741	DIN-rail socket with screw type terminals, 4 pole, package with protection diode module A1+, A2-	5-1415034-1

Accessories for PT 78 720, PT 78 730, PT 78 740, PT 78 741		
Type		Part Number
PT 17 016	Plastic retaining clip PT, relay height 29 mm	5-1415037-1
PT 17 024	Plastic retaining clip PT with ejecting func., relay height 29 mm	1816124-1
PT 28 800	Metal retaining clip PT, relay height 29 mm	5-1419111-9
PT 17 040	Marking tag	6-1415037-1
PT 17 0R6	Jumper bar, max load 12A for connection of up to 6 PT sockets	1860517-5

PT17 016

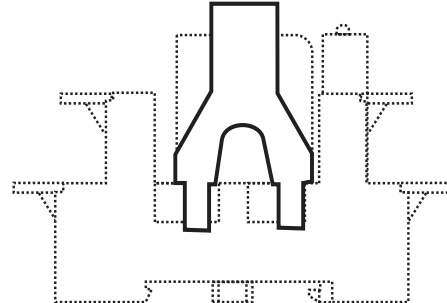

S0427-CH

PT17 024

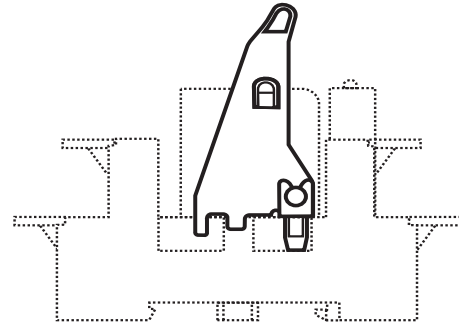

S0427-CI

Marking tags

- White marking area 28 x 6 mm
- Snaps on socket in up to 4 positions

Accessories Miniature Relay PT (Continued)

LED- and Protection Modules for PT 78 72P, PT 78 74P, PT 78 722, PT 78 742, PT 78 720, PT 78 730, PT 78 740

Easy insertion of module into the socket
Wiring in parallel to the coil

Type			Part Number
PTM TO 0A0	EM09	Protection diode (standard, A1+,A2-)	9-1415036-1
PTM TO 0L0	EM01	Protection diode (A1-, A2+)	1415037-1
PTM UO 524	EM02	RC-network 6...60 VAC	1-1415037-1
PTM UO 730	EM03	RC-network 110...230 VAC	2-1415037-1
PTM VO 524	EM04	Varistor 24 VAC	3-1415037-1
PTM VO 615	EM13	Varistor 115 VAC	6-1415365-1
PTM VO 730	EM05	Varistor 230 VAC	4-1415037-1
PTM DO 730	EM31	Residual current bypass RC 110...230 VAC	1415037-2
PTM RO 730	EM29	Residual current bypass resistor 110...230 VAC	1-1415539-2

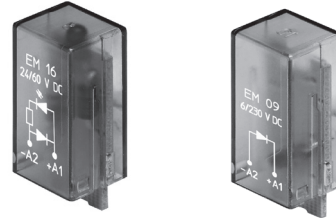

LED

PTM LO 024	EM18	red LED 6...24 VDC w. prot. diode (std, A1+, A2-)	5-1415036-1
PTM GO 024	EM12	green LED 6...24 VDC w. prot. diode (std, A1+, A2-)	2-1415036-1
PTM L1 024	EM08	red LED 6...24 VDC w. prot. diode (A1-, A2+)	8-1415036-1
PTM LO 060	EM16	red LED 24...60 VDC w. prot. diode (std, A1+, A2-)	5-1415539-3
PTM GO 060	EM25	green LED 24...60 VDC w. prot. diode (std, A1+, A2-)	7-1415539-7
PTM LO 110	EM19	red LED 60...110 VDC w. prot. diode (A1+, A2-)	2-1415392-1
PTM GO 110	EM26	green LED 60...110 VDC w. prot. diode (A1+, A2-)	1-1415539-7
PTM LO 220	EM27	red LED 110...220 VDC w. prot. diode (A1+, A2-)	1-1415539-4
PTM GO 220	EM28	green LED 110...220 VDC w. prot. diode (A1+, A2-)	1-1415539-6
PTM LO 524	EM07	red LED 6...24 VDC/VAC	6-1415036-1
PTM GO 524	EM11	green LED 6...24 VDC/VAC	3-1415036-1
PTM LO 560	EM14	red LED 24...60 VDC/VAC	1-1415539-3
PTM GO 560	EM30	green LED 24...60 VDC/VAC	1-1415539-5
PTM LO 730	EM06	red LED 110...230 VAC	7-1415036-1
PTM GO 730	EM10	green LED 110...230 VAC	4-1415036-1

Relay Packages

Complete packages consisting of a relay mounted on a socket: see Relay Package PT

Accessories Miniature Relay PT (Continued)

PT sockets for PCB mount and with solder terminals

PT 78 600, socket with solder terminals, 4-pole

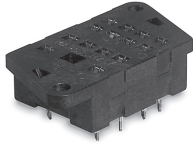

F0132-A

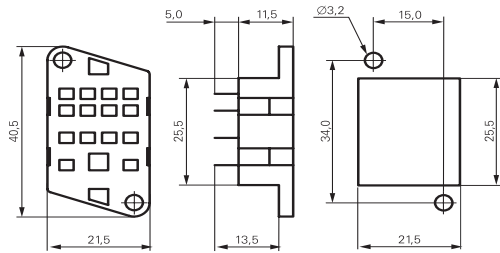

Chassis cut-out

S0308-AA

PT 78 602, PT 78 603, PT 78604, socket with PCB terminals, 2-, 3- and 4-pole

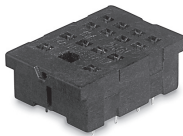

F0133-A

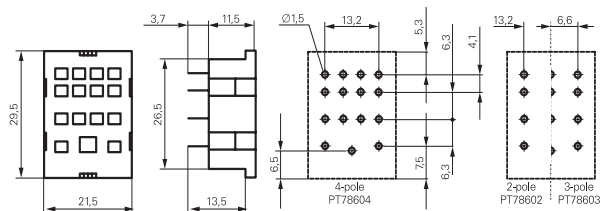

S0308-BB

PT 78 601, socket with solder terminals, 4-pole

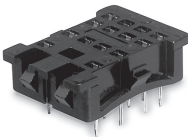

F0134-A

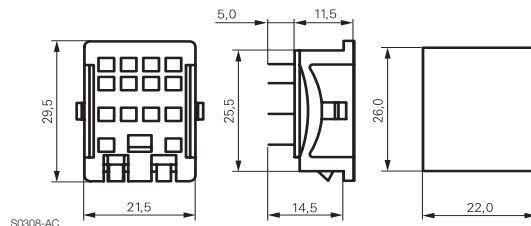

S0308-AC

Chassis cut-out

Technical data	2-pole	3-pole	4-pole
Rated voltage/max. switching voltage AC	240/400VAC		
Rated current	12 A	10 A	6 A
Dielectric strength			
coil-contact circuit	2500 V _{rms}	2500 V _{rms}	2500 V _{rms}
open contact circuit	1200 V _{rms}	1200 V _{rms}	1200 V _{rms}
adjacent contact circuits	2500 V _{rms}	2500 V _{rms}	2000 V _{rms}
Clearance / creepage			
coil-contact circuit	≥ 4/4 mm	≥ 4/4 mm	≥ 4/4 mm
adjacent contact circuits	≥3.5/9.5mm	≥2.6/3.5mm	≥1.8/3.5mm
Material group of insulation parts	IIIa		
Insulation to IEC 60664-1			
Type of insulation			
coil-contact circuit	basic	basic	basic
open contact circuit	functional	functional	functional
adjacent contact circuits	basic	basic	functional
Rated insulation voltage	250 V		
Pollution degree	2		
Rated voltage system	230 / 400 V		
Overvoltage category	III		

Material compliance: EU RoHS/ELV, China RoHS, REACH, Halogen content refer to the Product Compliance Support Center at www.te.com/customersupport/rohssupportcenter

Ambient temperature range	-40...+80°C
Terminals	pcb, solder terminals
Insertion cycles	A (10)
Max. Insertion Force total	100 N
Mounting distance	≥ 0, dense packing
Resistance to soldering heat	270°C / 10 s
Weight	6 g 7 g 7 g
Packaging unit	25 pcs

PT sockets

Type	Part Number
PT 78 600 Socket with solder terminals, 4 pole	4-1415043-1
PT 78 602 Socket with PCB terminals, 2 pole	5-1415043-1
PT 78 603 Socket with PCB terminals, 3 pole	1393162-5
PT 78 604 Socket with PCB terminals, 4 pole	3-1415043-1
PT 78 601 Socket with solder terminals, 4 pole	6-1415043-1

Accessories for PT 78 600, PT 78 601, PT 78 602, PT 78 603, PT 78 604

Type	Part Number
PT 28 802 Metal retaining clip PT, relay height 29 mm	1393162-1