



■ Features

- Universal AC input / Full range
- 2 pole EURO plug, Class II power unit
- No load power consumption < 0.075W
- **Energy efficiency Level VI**
- Comply with EU ErP and meet CoC Version 5
- Protections: Short circuit / Overload / Over voltage
- Fully enclosed plastic case
- Pass LPS
- 2 years warranty

■ Applications

- Consumer electronic devices
- Telecommunication devices
- Office facilities
- Industrial equipments

■ Description

GS06E is a highly reliable, 6W wall-mounted style single-output green adaptor series. This product is a class II power unit (no FG), equipped with a 2-Pin standard European AC power plug, adopting the input range from 90VAC to 264VAC. The entire series supplies different models with output voltages ranging between 5VDC and 48VDC that can satisfy the demands for various types of consumer electronic devices. With the efficiency up to 84% and the extremely low no-load power consumption below 0.075W, GS06E is compliant with EU ErP, and meet Code of Conduct(CoC) Version 5. The supreme feature allows the adaptor to save the energy when it is either under the operating mode or the standby mode. The entire series utilizes the 94V-0 flame retardant plastic case, providing the double insulation that effectively prevents electrical shock. GS06E is certified for the international safety regulations.

■ Model Encoding

GS 06 E - 1 P1J

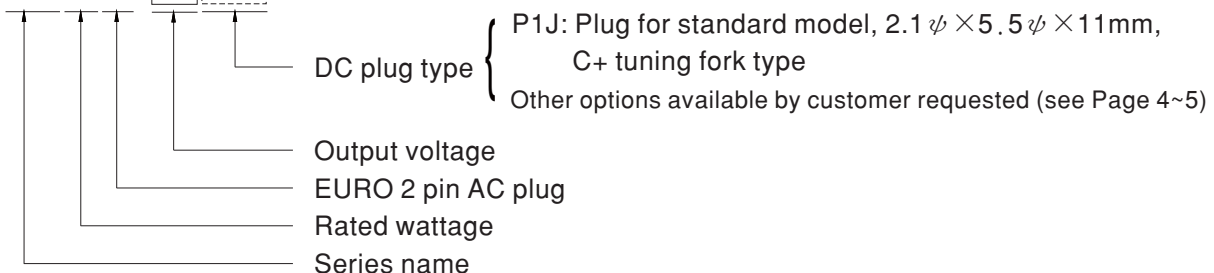



SPECIFICATION

ORDER NO.	GS06E-1P1J	GS06E-11P1J	GS06E-2P1J	GS06E-3P1J	GS06E-4P1J	GS06E-5P1J	GS06E-6P1J	GS06E-8P1J		
OUTPUT	SAFETY MODEL NO.	GS06E-1	GS06E-1-1	GS06E-2	GS06E-3	GS06E-4	GS06E-5	GS06E-6	GS06E-8	
	DC VOLTAGE <small>Note.2</small>	5V	7.5V	9V	12V	15V	18V	24V	48V	
	RATED CURRENT	1.00A	0.8A	0.66A	0.5A	0.4A	0.33A	0.25A	0.125A	
	CURRENT RANGE	0 ~ 1.00A	0 ~ 0.8A	0 ~ 0.66A	0 ~ 0.5A	0 ~ 0.4A	0 ~ 0.33A	0 ~ 0.25A	0 ~ 0.125A	
	RATED POWER	5W	6W	6W	6W	6W	6W	6W	6W	
	RIPPLE & NOISE (max.) <small>Note.3</small>	50mVp-p	80mVp-p	80mVp-p	100mVp-p	120mVp-p	150mVp-p	180mVp-p	200mVp-p	
	VOLTAGE TOLERANCE <small>Note.4</small>	±5.0%	±5.0%	±5.0%	±3.0%	±3.0%	±3.0%	±2.0%	±2.0%	
	LINE REGULATION <small>Note.5</small>	±0.5%	±0.5%	±0.5%	±0.5%	±0.5%	±0.5%	±0.5%	±0.5%	
	LOAD REGULATION <small>Note.6</small>	±5.0%	±5.0%	±5.0%	±3.0%	±3.0%	±3.0%	±2.0%	±2.0%	
SETUP, RISE, HOLD UP TIME	1000ms, 50ms, 12ms at full load									
INPUT	VOLTAGE RANGE	90 ~ 264VAC 127 ~ 370VDC								
	FREQUENCY RANGE	47 ~ 63Hz								
	EFFICIENCY (Typ.)	68%	74%	75%	77%	78%	78%	82%	84%	
	AC CURRENT	0.2A / 100VAC								
	INRUSH CURRENT (max.)	Cold start 30A / 115VAC 50A / 230VAC								
	LEAKAGE CURRENT(max.)	0.25mA / 240VAC								
PROTECTION	OVERLOAD	>105% rated output power for 5V ; >110% rated output power for 7.5 ~ 48V Protection type : Hiccup mode, recovers automatically after fault condition is removed								
	OVER VOLTAGE	>120% rated output voltage Protection type : Clamp by zener diode								
ENVIRONMENT	WORKING TEMP.	0 ~ +50°C (Refer to "Derating Curve")								
	WORKING HUMIDITY	20% ~ 90% RH non-condensing								
	STORAGE TEMP., HUMIDITY	-20 ~ +85°C, 10 ~ 95% RH non-condensing								
	TEMP. COEFFICIENT	±0.03% / °C (0 ~ 40°C)								
	VIBRATION	10 ~ 500Hz, 2G 10min./1cycle, period for 60min. each along X, Y, Z axes								
SAFETY & EMC <small>(Note. 7)</small>	SAFETY STANDARDS	TUV EN60950-1 approved								
	WITHSTAND VOLTAGE	I/P-O/P:4242VDC								
	ISOLATION RESISTANCE	I/P-O/P:100M Ohms / 500VDC / 25°C / 70% RH								
	EMC EMISSION	Parameter	Standard					Test Level / Note		
		Conducted emission	EN55032(CISPR32)					Class B		
		Radiated emission	EN55032(CISPR32)					Class B		
		Harmonic current	EN61000-3-2					Class A		
	EMC IMMUNITY	Parameter	Standard					Test Level /Note		
		ESD	EN61000-4-2					Level 3, 8KV air; Level 2, 4KV contact		
		RF field susceptibility	EN61000-4-3					Level 2, 3V/m		
		EFT bursts	EN61000-4-4					Level 2, 1KV		
		Surge susceptibility	EN61000-4-5					Level 3, 1KV/L-N		
		Conducted susceptibility	EN61000-4-6					Level 2, 3V		
		Magnetic field immunity	EN61000-4-8					Level 1, 1A/m		
Voltage dips , interruption		EN61000-4-11					>95% dip 0. 5 periods, 30% dip 25 periods, >95% interruptions 250 periods			
OTHERS	MTBF	500Khrs min. MIL-HDBK-217F(25°C)								
	DIMENSION	32*66*42.5mm (L*W*H)								
	PACKING	100g ; 90pcs / 10Kg / CARTON								
CONNECTOR	PLUG	See page 4~5 ; Other type available by customer requested								
	CABLE	See page 4~5 ; Other type available by customer requested								
NOTE	<p>1.All parameters are specified at 230VAC input, rated load, 25°C 70% RH ambient. 2.DC voltage: The output voltage set at point measure by plug terminal & 50% load. 3.Ripple & noise are measured at 20MHz by using a 12" twisted pair terminated with a 0.1µf & 47µf capacitor. 4.Tolerance: includes set up tolerance, line regulation, load regulation. 5.Line regulation is measured from low line to high line at rated load. 6.Load regulation is measured from 0% to 100% rated load 7.The power supply is considered as an independent unit, but the final equipment still need to re-confirm that the whole system complies with the EMC directives. For guidance on how to perform these EMC tests, please refer to "EMI testing of component power supplies." (as available on http://www.meanwell.com)</p>									



Derating Curve

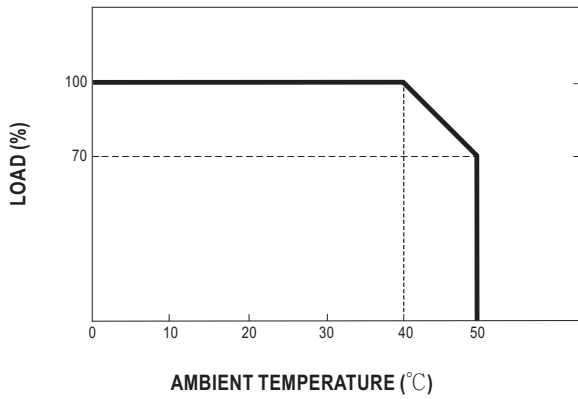

Static Characteristics

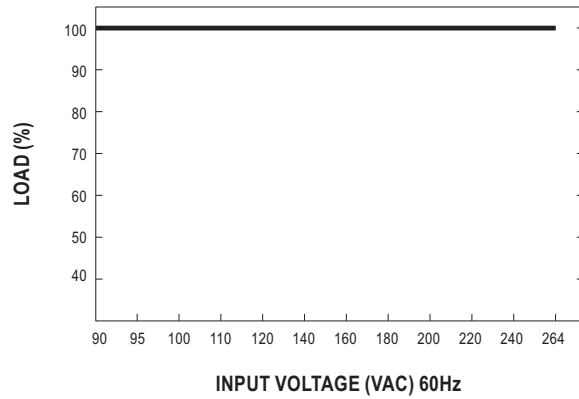

Mechanical Specification

Unit:mm

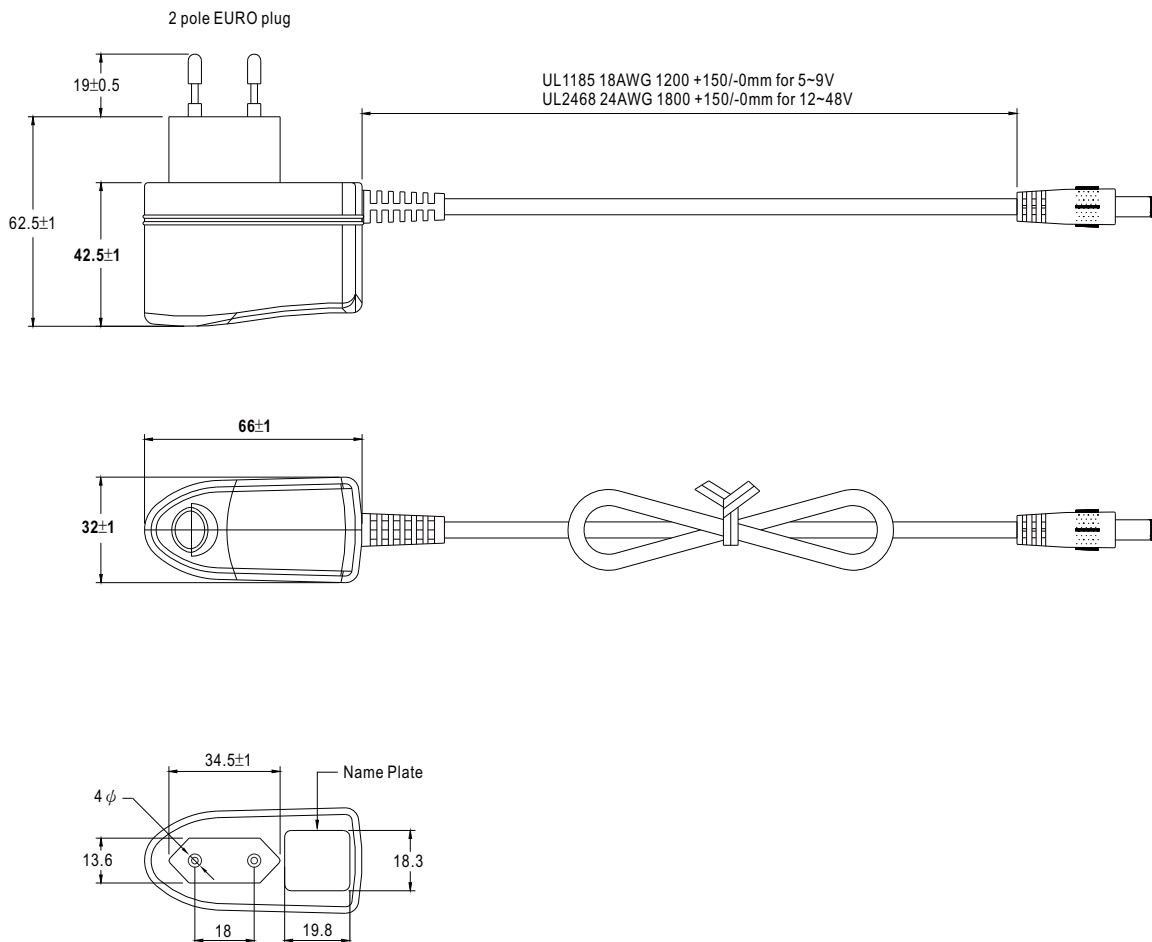











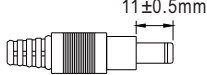



■ DC output plug

☉ Standard plug: P1J

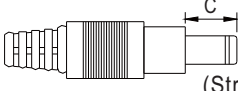
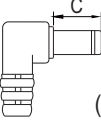
Unit:mm

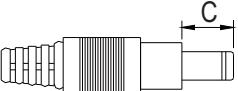
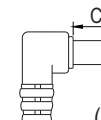
P1J		Pin Assignment
		
		Outside  Inside

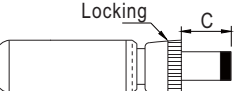
☉ Optional DC plug:

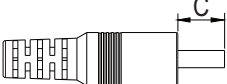
Tuning Fork Style		Type No.	A	B	C	
			OD	ID	L	
			P1I	5.5	2.1	9.5
		(Straight)	P1L	5.5	2.5	9.5
		(Right-angled)	P1M	5.5	2.5	11.0
		P1IR	5.5	2.1	9.5	
		P1JR	5.5	2.1	11.0	
		P1LR	5.5	2.5	9.5	
P1MR	5.5	2.5	11.0			
Barrel Style		Type No.	A	B	C	
			OD	ID	L	
			P2I	5.5	2.1	9.5
		(Straight)	P2J	5.5	2.1	11.0
		(Right-angled)	P2L	5.5	2.5	9.5
		P2M	5.5	2.5	11.0	
		P2IR	5.5	2.1	9.5	
		P2JR	5.5	2.1	11.0	
		P2LR	5.5	2.5	9.5	
		P2MR	5.5	2.5	11.0	
Lock Style		Type No.	A	B	C	
			OD	ID	L	
			P2S(S761K)	5.53	2.03	12.06
		Locking	P2K(761K)	5.53	2.54	12.06
		SWITCHCRAFT original or equivalent	P2C(S760K)	5.53	2.03	9.52
		P2D(760K)	5.53	2.54	9.52	
Min. Pin Style		Type No.	A	B	C	
			OD	ID	L	
			P3A	2.35	0.7	11.0
		EIAJ equivalent	P3B	4.0	1.7	11.0
		P3C	4.75	1.7	11.0	

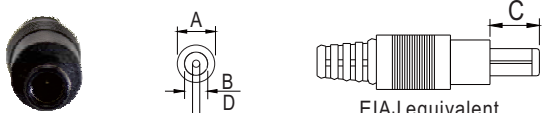
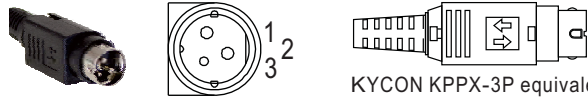
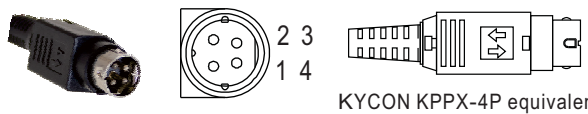
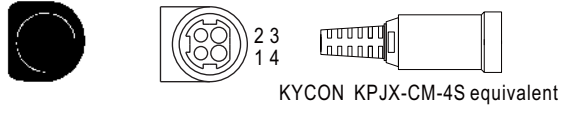
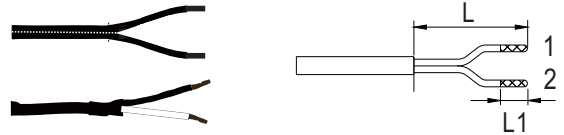

Center Pin Style	Type No.	A	B	C	D
		OD	ID	L	Center Pin
 <p>EIAJ equivalent</p>	P4A	5.5	3.4	11.0	1.0
	P4B	6.5	4.4	11.0	1.4
	P4C	7.4	5.1	11.0	0.6
Min. DIN 3 Pin with Lock (male)	Type No.	Pin Assignment			
 <p>KYCON KPPX-3P equivalent</p>	R6B	PIN No.		Output	
		1	+Vo		
		2	-Vo		
		3	+Vo		
Min. DIN 4 Pin with Lock (male)	Type No.	Pin Assignment			
 <p>KYCON KPPX-4P equivalent</p>	R7B	PIN No.		Output	
		1	+Vo		
		2	-Vo		
		3	-Vo		
		4	+Vo		
Min. DIN 4 Pin with Lock (female)	Type No.	Pin Assignment			
 <p>KYCON KPJX-CM-4S equivalent</p>	R7BF	PIN No.		Output	
		1	+Vo		
		2	-Vo		
		3	-Vo		
		4	+Vo		
Stripped and tinned leads	Type No.	Pin Assignment			
 <p>Length of Land L1 by request (MW's standard length, L: <u>25</u> mm, L1: <u>10</u> mm)</p>	by customer	PIN No.		Output	
		1 (Ribbed or White)	+Vo		
		2 (Letter or Black)	-Vo		

■ **Installation Manual**

Please refer to : <http://www.meanwell.com/manual.html>