



Figure can vary

Part no.: 68020203
MLC500T20-300G
Safety light curtain transmitter



Contents

- Technical data
- Dimensioned drawings
- Electrical connection
- Suitable receivers
- Part number code
- Notes
- Accessories

Technical data

Basic data	
Series	MLC 500
Device type	Transmitter
Cascading	Guest
Contains	2x BT-NC sliding block
Application	Hand protection
Characteristic parameters	
Type	4 , IEC/EN 61496
SIL	3 , IEC 61508
SILCL	3 , IEC/EN 62061
Mission time T _M	20 years , EN ISO 13849-1
Protective field data	
Resolution	20 mm
Protective field height	300 mm
Operating range	0 ... 15 m
Optical data	
Number of beams	24 Piece(s)
Light source	LED , Infrared
LED light wavelength	940 nm
Transmitted-signal shape	Pulsed
LED group	Exempt group in acc. with EN 62471:2008
Connection	
Number of connections	1 Piece(s)
Connection 1	
Type of connection	Cable with connector
Function	Cascade, Host In Cascade, Middle Guest In
Cable length	330 mm
Sheathing material	PUR
Thread size	M12
Material	Plastic
No. of pins	8 -pin
Mechanical data	
Dimension (W x H x L)	29 mm x 314 mm x 53 mm
Housing material	Metal , Aluminum
Lens cover material	Plastic / PMMA
Material of end caps	Diecast zinc
Net weight	423 g
Housing color	Yellow, RAL 1021
Type of fastening	Groove mounting Mounting bracket Swivel mount
Environmental data	

Part no.: 68020203 – MLC500T20-300G – Safety light curtain transmitter

Ambient temperature, operation	0 ... 55 °C
Ambient temperature, storage	-30 ... 70 °C
Relative humidity (non-condensing)	0 ... 95 %

Certifications	
Degree of protection	IP 65
Protection class	III
Certifications	c CSA US c TÜV NRTL US TÜV Süd
Vibration resistance	50 m/s ²
Shock resistance	100 m/s ²
US patents	US 6,418,546 B

Classification	
Customs tariff number	85365019
eCl@ss 8.0	27272704
eCl@ss 9.0	27272704
ETIM 5.0	EC002549
ETIM 6.0	EC002549

Dimensioned drawings

All dimensions in millimeters

Calculation of the effective protective field height $H_{PFE} = H_{PFN} + B + C$

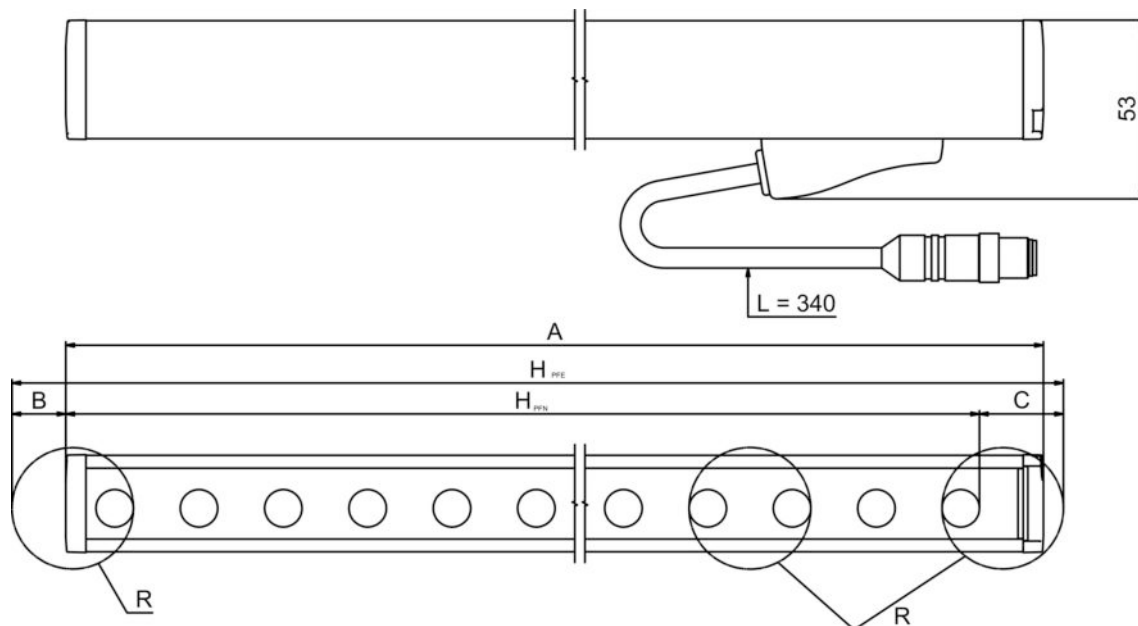

H_{PFE} Effective protective field height = 317 mm

H_{PFN} Nominal protective field height = 300 mm

A Total height = 314 mm

B 7 mm

C 10 mm

R Effective protective field height H_{PFE} goes beyond the dimensions of the optics area to the outer borders of the circles labeled with R.

Electrical connection

Connection 1	
Type of connection	Cable with connector
Function	Cascade, Host In Cascade, Middle Guest In
Cable length	330 mm
Sheathing material	PUR
Cable color	Black
Type of stranding	Pair stranding (twisted pair)
Wire cross section	0.14 mm ²
Thread size	M12
Type	Male
Material	Plastic
No. of pins	8 -pin
Encoding	A-coded

Suitable receivers

	Part no.	Designation	Article	Description
	68021203	MLC520R20-300G	Safety light curtain receiver	Resolution: 20 mm Protective field height: 300 mm Response time: 5 ms Connection: Cable with connector, M12, Plastic, 8 -pin, 330 mm, PUR

Part number code

 Part designation: **MLCxyy-za-hhhhei-ooo**

MLC	Safety light curtain
x	Series: 3: MLC 300 5: MLC 500
yy	Function classes: 00: transmitter 01: transmitter (AIDA) 02: transmitter with test input 10: basic receiver - automatic restart 11: basic receiver - automatic restart (AIDA) 20: standard receiver - EDM/RES selectable 30: extended receiver - blanking/muting
z	Device type: T: transmitter R: receiver
a	Resolution: 14: 14 mm 20: 20 mm 30: 30 mm 40: 40 mm 90: 90 mm
hhh	Protective field height: 150 ... 3000: from 150 mm to 3000 mm
e	Host/Guest (optional): H: Host MG: Middle Guest G: Guest
i	Interface (optional): /A: AS-i

Part no.: 68020203 – MLC500T20-300G – Safety light curtain transmitter

MLC	Safety light curtain
000	Option: /V: high Vibration-proof EX2: explosion protection (zones 2 + 22) SPG: Smart Process Gating

Note
A list with all available device types can be found on the Leuze electronic website at www.leuze.com .

Notes

Observe intended use!
<ul style="list-style-type: none"> The product may only be put into operation by competent persons. Only use the product in accordance with its intended use.

Accessories

Connection technology - Interconnection cables

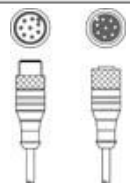
	Part no.	Designation	Article	Description
	429278	CB-M12-2000E-8TP	Interconnection cable	Connection 1: Connector, M12, Axial, Female, A-coded, 8 -pin Connection 2: Connector, M12, Axial, Male, A-coded, 8 -pin Shielded: Yes Cable length: 2,000 mm Sheathing material: PUR

Mounting technology - Mounting brackets

	Part no.	Designation	Article	Description
	429006	BT-2L-HG	Mounting device set	Mounting bracket, at device: Screw type Material: Metal

Mounting technology - Swivel mounts



	Part no.	Designation	Article	Description
	429395	BT-2HF-G	Mounting bracket set	Contains: 2x BT-HF swivel mount, 2 cylinders for mounting on the light curtain Fastening, at system: Through-hole mounting Mounting bracket, at device: Clampable Type of mounting device: Turning, 360° Material: Metal, Plastic

Part no.: 68020203 – MLC500T20-300G – Safety light curtain transmitter

Alignment aids

	Part no.	Designation	Article	Description
	520101	AC-ALM-M	Alignment aid	Housing material: Plastic

Services

	Part no.	Designation	Article	Description
	S981050	CS40-I-140	Safety inspection "Safety light barriers"	<p>Details: Checking of a safety light barrier application in accordance with current standards and guidelines. Inclusion of the device and machine data in a database, production of a test log per application.</p> <p>Conditions: It must be possible to stop the machine, support provided by customer's employees and access to the machine for Leuze employees must be ensured.</p> <p>Restrictions: Travel costs and accommodation expenses charged separately and according to expenditure.</p>
	S981046	CS40-S-140	Start-up support	<p>Details: For safety devices including stopping time measurement and initial inspection.</p> <p>Conditions: Devices and connection cables are already mounted, price not including travel costs and, if applicable, accommodation expenses.</p> <p>Restrictions: Max. 2 h., no mechanical (mounting) and electrical (wiring) work performed, no changes (attachments, wiring, programming) to third-party components in the nearby environment.</p>

Note

A list with all available accessories can be found on the Leuze electronic website in the Download tab of the article detailed page.