

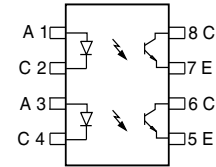

## Optocoupler, Phototransistor Output, Dual Channel, SOIC-8 package

### Features

- Two Channel Coupler
- SOIC-8A Surface Mountable Package
- Standard Lead Spacing of .05 "
- Available only on Tape and Reel Option (Conforms to EIA Standard 481-2)
- Isolation Test Voltage, 3000 V<sub>RMS</sub>
- Compatible with Dual Wave, Vapor Phase and IR Reflow Soldering

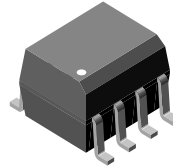

1179018

### Agency Approvals

- UL - File No. E52744 System Code Y

### Description

The ILD205T/ 206T/ 207T/ 211T/ 213T/ 217T are optically coupled pairs with a Gallium Arsenide infrared LED and a silicon NPN phototransistor. Signal information, including a DC level, can be transmitted by the device while maintaining a high degree of electrical isolation between input and output. The ILD205T/ 206T/ 207T/ 211T/ 213T/ 217T come in a standard SOIC-8A small outline package for surface mounting which makes it ideally suited for high density applications with limited space. In addition to eliminating through-holes requirements, this package conforms to standards for surface mounted devices.

A specified minimum and maximum CTR allows a narrow tolerance in the electrical design of the adjacent circuits. The high BV<sub>CEO</sub> of 70 V gives a higher safety margin compared to the industry standard of 30 V.

### Order Information

Part	Remarks
ILD205T	CTR 40 - 80 %, SOIC-8
ILD206T	CTR 63 - 125 %, SOIC-8
ILD207T	CTR 100 - 200 %, SOIC-8
ILD211T	CTR > 20 %, SOIC-8
ILD213T	CTR > 100 %, SOIC-8
ILD217T	CTR > 100 %, SOIC-8

For additional information on the available options refer to Option Information.

### Absolute Maximum Ratings

T<sub>amb</sub> = 25 °C, unless otherwise specified

Stresses in excess of the absolute Maximum Ratings can cause permanent damage to the device. Functional operation of the device is not implied at these or any other conditions in excess of those given in the operational sections of this document. Exposure to absolute Maximum Rating for extended periods of the time can adversely affect reliability.

### Input

Parameter	Test condition	Symbol	Value	Unit
Peak reverse voltage		V <sub>R</sub>	6.0	V
Peak pulsed current	1.0 μs, 300 pps		1.0	A
Continuous forward current per channel			30	mA
Power dissipation		P <sub>diss</sub>	50	mW
Derate linearly from 25 °C			0.66	mW/°C

### Output

Parameter	Test condition	Symbol	Value	Unit
Collector-emitter breakdown voltage		$BV_{CEO}$	70	V
Emitter-collector breakdown voltage		$BV_{ECO}$	7.0	V
Power dissipation per channel		$P_{diss}$	125	mW
Derate linearly from 25 °C			1.67	mW/°C

### Coupler

Parameter	Test condition	Symbol	Value	Unit
Total package dissipation ambient (2 LEDs + 2 detectors, 2 channels)		$P_{tot}$	300	mW
Derate linearly from 25 °C			4.0	mW/°C
Storage temperature		$T_{stg}$	- 55 to + 150	°C
Operating temperature		$T_{amb}$	- 55 to + 100	°C
Soldering time from 260 °C		$T_{sld}$	10	sec.

### Electrical Characteristics

$T_{amb} = 25\text{ °C}$ , unless otherwise specified

Minimum and maximum values are testing requirements. Typical values are characteristics of the device and are the result of engineering evaluation. Typical values are for information only and are not part of the testing requirements.

### Input

Parameter	Test condition	Symbol	Min	Typ.	Max	Unit
Forward voltage	$I_F = 10\text{ mA}$	$V_F$		1.2	1.55	V
Reverse current	$V_R = 6.0\text{ V}$	$I_R$		0.1	100	$\mu\text{A}$
Capacitance	$V_R = 0$	$C_O$		25		pF

### Output

Parameter	Test condition	Symbol	Min	Typ.	Max	Unit
Collector-emitter breakdown voltage	$I_C = 10\text{ }\mu\text{A}$	$BV_{CEO}$	70			V
Emitter-collector breakdown voltage	$I_E = 10\text{ }\mu\text{A}$	$BV_{ECO}$	7.0			V
Collector-emitter leakage current	$V_{CE} = 10\text{ V}$ , $I_F = 0$	$I_{CEO}$		5.0	50	nA
Collector-emitter capacitance	$V_{CE} = 0$	$C_{CE}$		10		pF

### Coupler

Parameter	Test condition	Symbol	Min	Typ.	Max	Unit
Collector-emitter saturation voltage	$I_F = 10\text{ mA}$ , $I_C = 2.5\text{ mA}$	$V_{CE(sat)}$			0.4	V
Capacitance (input-output)		$C_{IO}$		0.5		pF
Isolation test voltage	$t = 1.0\text{ sec.}$	$V_{ISO}$	3000			$V_{RMS}$
Resistance, input to output		$R_{IO}$		100		$G\Omega$



## Current Transfer Ratio

Parameter	Test condition	Part	Symbol	Min	Typ.	Max	Unit
DC Current Transfer Ratio	$V_{CE} = 5.0 \text{ V}, I_F = 10 \text{ mA}$	ILD205T	$CTR_{DC}$	40		80	%
		ILD206T	$CTR_{DC}$	63		125	%
		ILD207T	$CTR_{DC}$	100		200	%
		ILD211T	$CTR_{DC}$	20			%
		ILD213T	$CTR_{DC}$	100			%
	$V_{CE} = 5.0 \text{ V}, I_F = 1.0 \text{ mA}$	ILD205T	$CTR_{DC}$	13	30		%
		ILD206T	$CTR_{DC}$	22	45		%
		ILD217T	$CTR_{DC}$	100	120		%

## Switching Characteristics

Parameter	Test condition	Symbol	Min	Typ.	Max	Unit
Turn-on time	$I_C = 2.0 \text{ mA}, R_L = 100 \Omega, V_{CC} = 5.0 \text{ V}$	$t_{on}$	5.0			$\mu\text{s}$
Turn-off time	$I_C = 2.0 \text{ mA}, R_L = 100 \Omega, V_{CC} = 5.0 \text{ V}$	$t_{off}$	4.0			$\mu\text{s}$

## Typical Characteristics ( $T_{amb} = 25 \text{ }^\circ\text{C}$ unless otherwise specified)

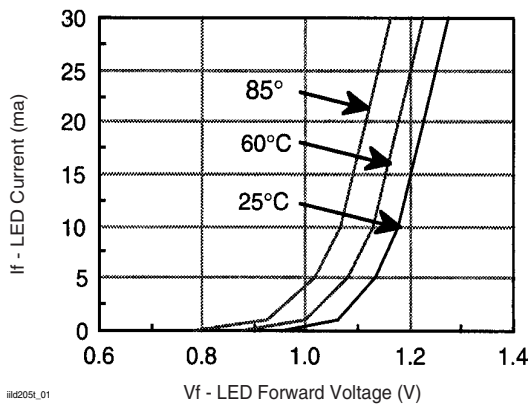

ild205L\_01

$V_f$  - LED Forward Voltage (V)

Fig. 1 Forward Current vs. Forward Voltage

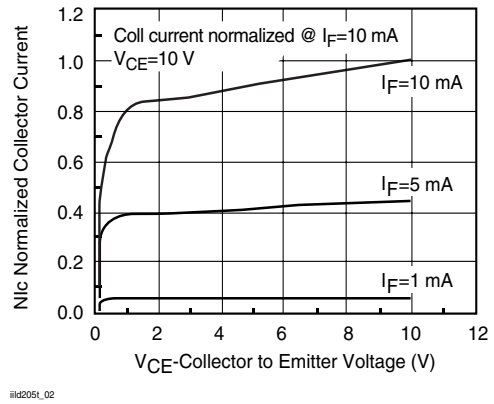

ild205L\_02

Fig. 2 Collector-Emitter Current vs. Temperature

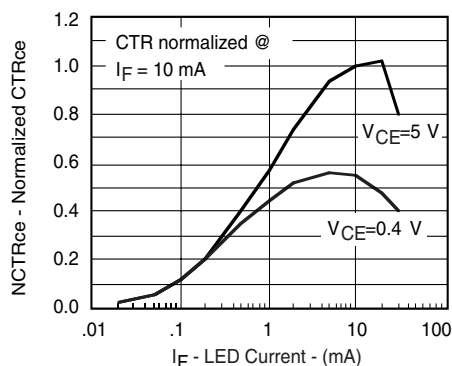

ild205t\_03

Fig. 3 Normalized  $CTR_{ce}$  vs. Forward Current

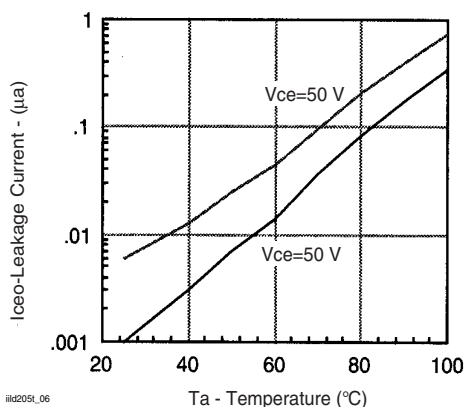

ild205t\_06

Fig. 6 Collector Current vs. Ambient Temperature

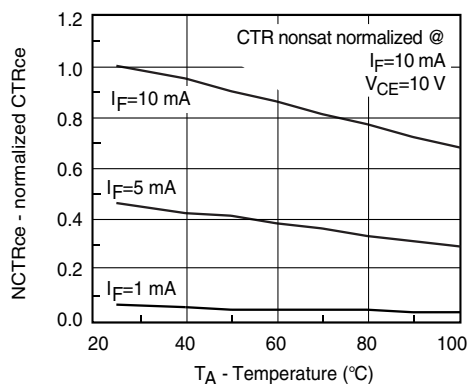

ild205t\_04

Fig. 4 Current Transfer Ratio (normalized) vs. Ambient Temperature

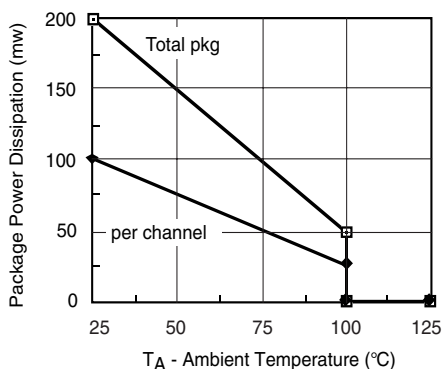

ild205t\_07

Fig. 7 Power Dissipation vs. Ambient Temperature

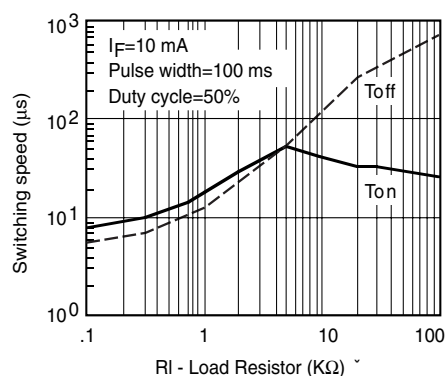

ild205t\_01

Fig. 5 Switching Speed vs. Load Resistor

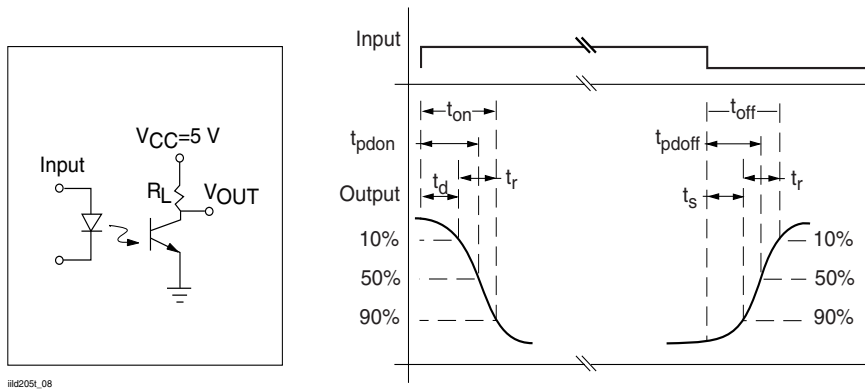
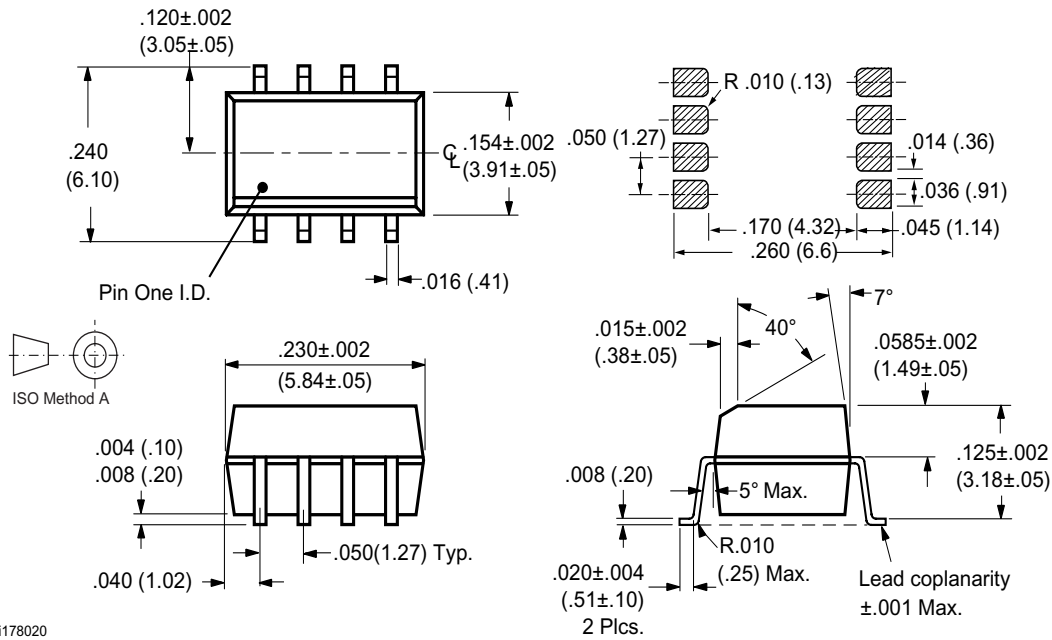

Fig. 8 Switching Time Test Schematic and Waveform

## Package Dimensions in Inches (mm)



i178020

### Ozone Depleting Substances Policy Statement

It is the policy of **Vishay Semiconductor GmbH** to

1. Meet all present and future national and international statutory requirements.
2. Regularly and continuously improve the performance of our products, processes, distribution and operating systems with respect to their impact on the health and safety of our employees and the public, as well as their impact on the environment.

It is particular concern to control or eliminate releases of those substances into the atmosphere which are known as ozone depleting substances (ODSs).

The Montreal Protocol (1987) and its London Amendments (1990) intend to severely restrict the use of ODSs and forbid their use within the next ten years. Various national and international initiatives are pressing for an earlier ban on these substances.

**Vishay Semiconductor GmbH** has been able to use its policy of continuous improvements to eliminate the use of ODSs listed in the following documents.

1. Annex A, B and list of transitional substances of the Montreal Protocol and the London Amendments respectively
2. Class I and II ozone depleting substances in the Clean Air Act Amendments of 1990 by the Environmental Protection Agency (EPA) in the USA
3. Council Decision 88/540/EEC and 91/690/EEC Annex A, B and C (transitional substances) respectively.

**Vishay Semiconductor GmbH** can certify that our semiconductors are not manufactured with ozone depleting substances and do not contain such substances.

**We reserve the right to make changes to improve technical design  
and may do so without further notice.**

Parameters can vary in different applications. All operating parameters must be validated for each customer application by the customer. Should the buyer use Vishay Semiconductors products for any unintended or unauthorized application, the buyer shall indemnify Vishay Semiconductors against all claims, costs, damages, and expenses, arising out of, directly or indirectly, any claim of personal damage, injury or death associated with such unintended or unauthorized use.

Vishay Semiconductor GmbH, P.O.B. 3535, D-74025 Heilbronn, Germany  
Telephone: 49 (0)7131 67 2831, Fax number: 49 (0)7131 67 2423

This datasheet has been download from:

[www.datasheetcatalog.com](http://www.datasheetcatalog.com)

Datasheets for electronics components.