

03 0304

Circular connectors with threaded joint M16 acc. to IEC 61076-2-106, IP40/IP67/IP68



Chassis socket acc. to IEC 61076-2-106, IP68, with threaded joint and solder terminals, for front mounting

03 0304

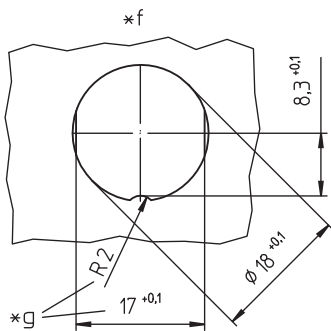
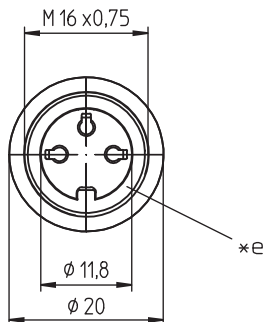
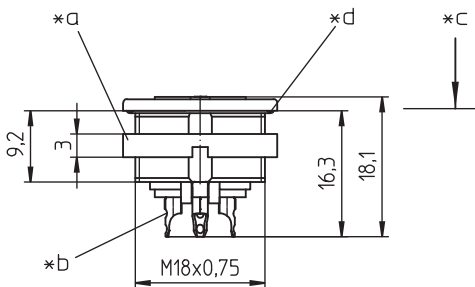
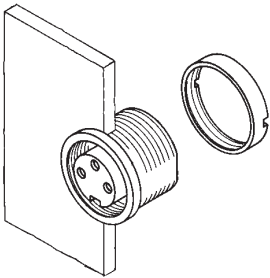

Environmental conditions

Temperature range -40 °C/+85 °C

Materials

Insulating body PA GF, V-0 according to UL94
 Contact bush CuZn, silver-plated and flash gold-plated (3-8 poles)
 CuZn, pre-nickel and gold-plated (12-14 poles)
 Housing Zn diecast, pre-copper and nickel-plated
 Ring screw CuZn, nickel-plated
 Seal CR (flat), NBR (O-ring)

Mechanical data

Insertion force/contact $\leq 5.0 \text{ N}^1$
 Withdrawal force/contact $\geq 1.2 \text{ N}$ (3-8 poles)
 $\geq 0.9 \text{ N}$ (12-14 poles)¹
 Tightening torque connector 1-3 Nm
 Tightening torque nut 1-3 Nm
 Protection class IP68²

¹ measured with a polished steel pin, nominal thickness 1.5 mm (1.0 mm with 12-14 poles)

² according to IEC DIN EN 60529, only in locked condition with an appropriate counterpart; IPX8 requirements under agreement between manufacturer and user

Connectable conductors for solder area

Section $\leq 0.75 \text{ mm}^2$ (AWG 20)
 (3-8 poles)
 $\leq 0.25 \text{ mm}^2$ (AWG 24)
 (12-14 poles)

Electrical data (at $T_{\text{amb}} 20 \text{ }^\circ\text{C}$)

Contact resistance $\leq 5 \text{ m}\Omega$
 Rated current 5 A ($T_{\text{amb}} 40 \text{ }^\circ\text{C}$, 3-8 poles)
 3 A ($T_{\text{amb}} 40 \text{ }^\circ\text{C}$, 12-14 poles)
 Rated voltage with pollution degree 1:
 300 V (versions 03, 04, 05-1, 06, 07)
 100 V (versions 05, 07-1, 08, 08-1)
 160 V (versions 12, 14)
 with pollution degree 2:
 250 V (versions 03, 04)
 32 V (versions 05, 07-1, 08, 08-1)
 160 V (versions 05-1, 06, 07, 12, 14)
 Rated impulse voltage 1500 V (versions 03, 04, 05-1, 06, 07, 12, 14)
 500 V (versions 05, 07-1, 08, 08-1)
 Material group II (IEC)/1 (UL) (400 \leq CTI $<$ 600)
 Overvoltage category I
 Insulation resistance $> 100 \text{ M}\Omega$

03 0304

Pin configurations, solder side view

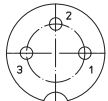

03-a
0304 03

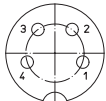

04-a
0304 04

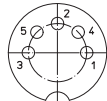

05-b
0304 05

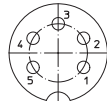

05-a
0304 05-1

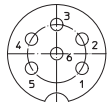

06-a
0304 06

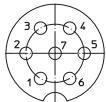

07-a
0304 07

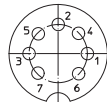

07-b
0304 07-1



0304 08



08-a
0304 08-1



12-a
0304 12

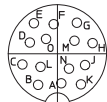

14-a
0304 14

Associated products

Counterparts

☑ 0331	☑ 0332	☑ 0332-1
☑ 033200	☑ 0365	☑ 036500

Accessories

☑ 0322 C 16	☑ 0381	☑ 038199
☑ 0382	☑ 0384	☑ 0385
☑ 038799		

- *a nut enclosed separately
- *b cup-shaped solder terminal
- *c mounting direction
- *d O-ring gasket
- *e flat gasket
- *f port in mounting plate
- *g anti-rotation, alternative execution

03

0304

Designation	Pole Number	PU (Pieces)	MDQ (Pieces)
0304 03	3	50	100
0304 04	4	50	100
0304 05	5	50	100
0304 05-1	5	50	100
0304 06	6	50	100
0304 07	7	50	100
0304 07-1	7	50	100
0304 08	8	50	100
0304 08-1	8	50	100
0304 12	12	50	100
0304 14	14	50	100

Packaging:

in a cardboard box