

Ultrasonic Sonar Ranging IC - PW0268

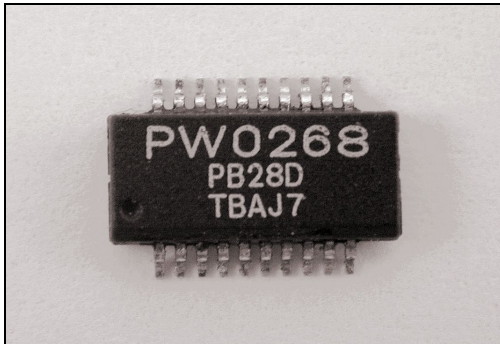

SSOP20

Features:

- Operates in 6 – 10 V single voltage
- Wide operation frequency range up to 250KHz
- Temperature controlled oscillator traces resonant frequency drift of transducers
- Built-in 32 steps time controlled gain amplifier
- Built-in band pass filter of less external tuned components
- Bi-direction I/O for both driving pulse and echo
- Adjustable system clock for various detection range
- Suitable for car reversing aids, tape measurements and other sonar ranging applications.

Description:

The PW-0268 ultrasonic sonar ranging IC is designed specially for ultrasonic echo ranging application. This chip consists of an external tunable RC oscillator with a special feature of automatic frequency tracing, which compensates the resonant frequency shift of used transducer due to temperature change, a stage of fixed gain pre-amplifier setting externally, a 32 steps time controlled gain amplifier, a less external components band pass filter, a comparator converts analog signal to TTL digital signal for external μ P processing and a tunable timer acts as time reference for chip clock.

The I_O (pin 1) is a bi-direction I/O pin, which is designed as an open collector connection with a pull high internal resistor. Once the I_O pin is being pulled low by external transistor, the RC oscillator operates and generates a tone burst signal at DRIVER₀ (pin 11) for driving power output stage. The I_O pin becomes as low level if an effective echo signal is detected.

The reflected echo signal feeds into the first stages of pre-amplifier thru ECHO (pin 10), the gain of pre-amplifier varies upon the sensitivity of used transducer which can be set with an external resistor between ECHO (pin 10) and GR_I (pin 9). A 32 steps time controlled gain amplifier from TCG_I (pin 7) to TCG_O (pin 6) be synchronized with the end of control pulse signal and be reset by the beginning of next control pulse.

Only need few passive components for active band pass filter, which consists of one stage of low pass filter between LP_I (pin 5) and LP_O (pin 4) and another stage of high pass filter from HP_I (pin 3) to HP_O (pin 2). The center frequency and bandwidth are decided by using different type of ultrasonic transducers and applications.

The amplified echo signal after band pass filter routes to a comparator, which shapes and converts the analog echo signal into digital signal output at I_O (pin 1) for further μ P handling.

A unique temperature controlled oscillator function traces the resonant frequency drift of ultrasonic transducers, which causes by environment temperature changing. Just simply adds one dual diode and one resistor between DRIVER_O (pin 11) and Ftrace (pin 12).

Block Diagram

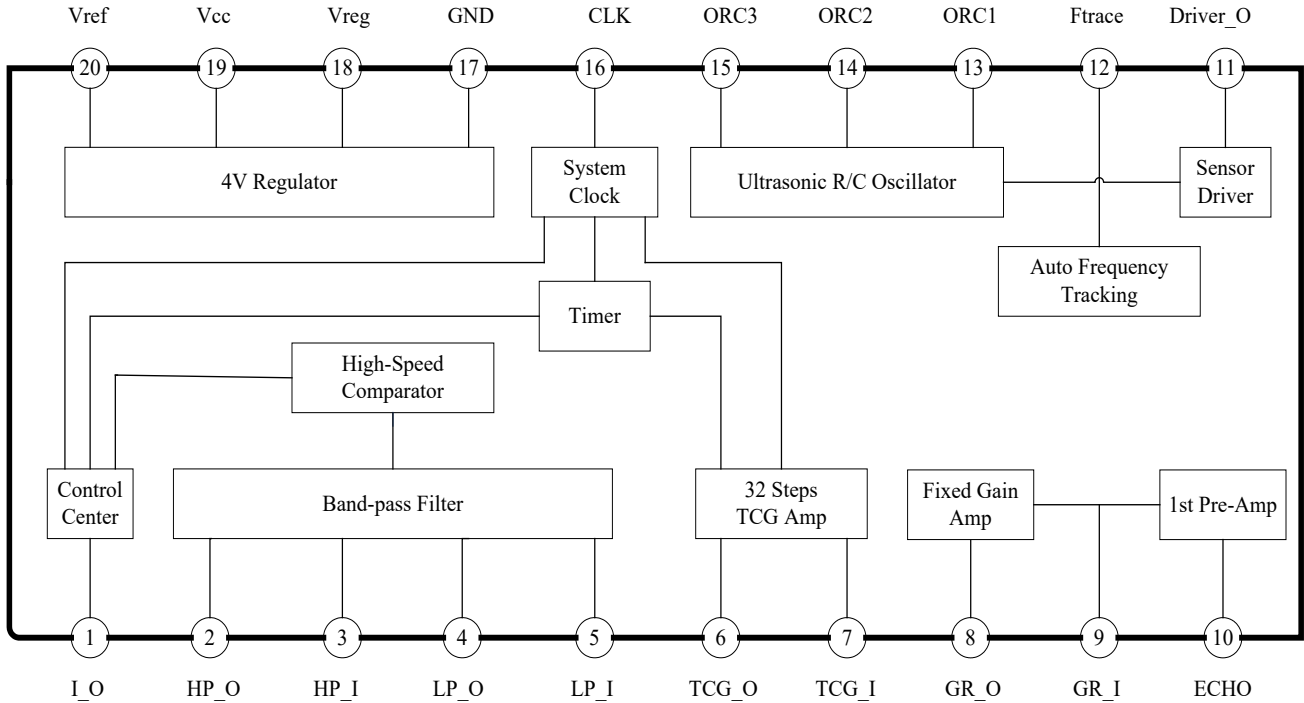

Pin Assignment

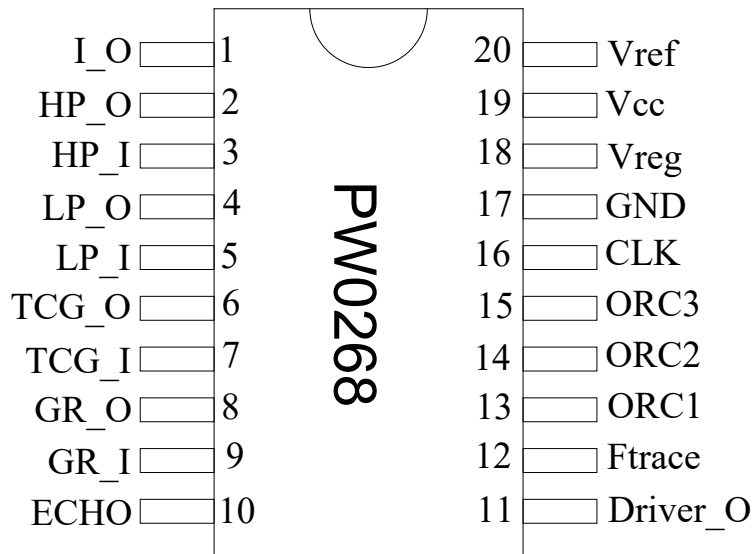

Specifications:

Unless otherwise specified, all data measured under $V_{cc} = 9V$, $F = 40KHz$

Parameter	Symbol	Condition	Min.	Typ.	Max.	Unit
Supply Voltage	V_{cc}	$V_{reg} = 4V$	5.5		11	V
Supply Current	I_{cc}	$V_{cc} = 6 \sim 10V$	8	11	14	mA
Regulated Voltage	V_{reg}	$V_{cc} = 6 \sim 10V$	3.8	4	5	V
Stability of V_{reg}	V_{lr}	$V_{cc} = 6 \sim 10V, \pm 3\%$	-3.0	0	+3.0	%
Reference Voltage	V_{ref}	$V_{cc} = 6 \sim 10V, RL > 2K\Omega$	0.4	0.44	0.5	V_{reg}
Op-Amp Slew Rate	SR	$V_{in} = 3V_{pp}$	5	-	-	$V/\mu S$
Comparator Trigger Level	T_{comp}	Over V_{ref}	300	350	400	mV
System Clock Frequency	CLKf	$R=33K\Omega, C=22pF$	610	660	710	KHz
System Clock Frequency Range	CLKr		0.001	-	1500	KHz
Ultrasonic Oscillation Frequency	Fosc f	$R=5.6K, C=1000pF$	38	40	42	KHz
Ultrasonic Oscillation Frequency Range	Fosc r		0.001	-	500	KHz
2 nd Amp Gain	GR		29	30	31	dB
Time Controlled Gain Amplifier	TCGain	Min(1x, 0dB)	-1	0	+1	dB
		Max(58x, 35.2dB)	34	35	36	dB
Bandwidth of 2nd Amp	GRbw	Gain = 50dB	150	170	200	KHz
Driving Current	I_{drv}	Driver O	-	20	40	mA
	I_{sink}	Driver O	-	-20	-80	
Input Voltage Level	I_{OVIH}		-	0.3	0.4	V_{cc}
	I_{OVIL}		0.15	0.2	-	
Output Voltage Level	I_{OVOH}		-	0.9	1	V_{cc}
	I_{OVOL}		0	0.05	-	
Input Low Level Current	I_{OIOL}		-	-10	-20	mA
I_O Internal Pull Up Resistance	Rup		3.5	5	6.5	K Ω

Absolute Maximum Ratings

Description	Symbol	Condition	Min.	Max.	Unit
Supply Voltage	V_{cc}		0	12	V
Operation Temperature	T_{opr}		-40	+85	$^{\circ}C$
Storage Temperature	T_{stg}		-65	+150	$^{\circ}C$
Max. Pin Input Voltage	V_{imax}	$I_{_O}, V_{cc}$	-0.3	$V_{cc}+0.3$	V
		Others	-0.3	$V_{reg}+0.3$	
Max. Input Current	I_{imax}	*	-10	+10	mA

*To prevent latch up, the instantaneous input current should be no large than 100mA for each pins.

Pins Description:

Pin	Name	Description	Pin	Name	Description
1	I O	Input/Output	11	Driver O	Transducer driving output
2	HP O	High pass filter output	12	Ftrace	Frequency tracing input
3	HP I	High pass filter input	13	ORC1	RC oscillator: terminal 1
4	LP O	Low pass filter output	14	ORC2	RC oscillator: terminal 2
5	LP I	Low pass filter input	15	ORC3	RC oscillator: terminal 3
6	TCG O	Time controlled gain output	16	CLK	System clock
7	TCG I	Time controlled gain input	17	GND	Ground
8	GR_O	External adjustable gain output	18	Vreg	Regulated voltage for internal analogue devices
9	GR_I	External adjustable gain input	19	Vcc	Power supply
10	ECHO	Receiving echo input	20	Vref	Reference voltage output

Application Circuit: for car reversing aids (values should be changed for other applications)

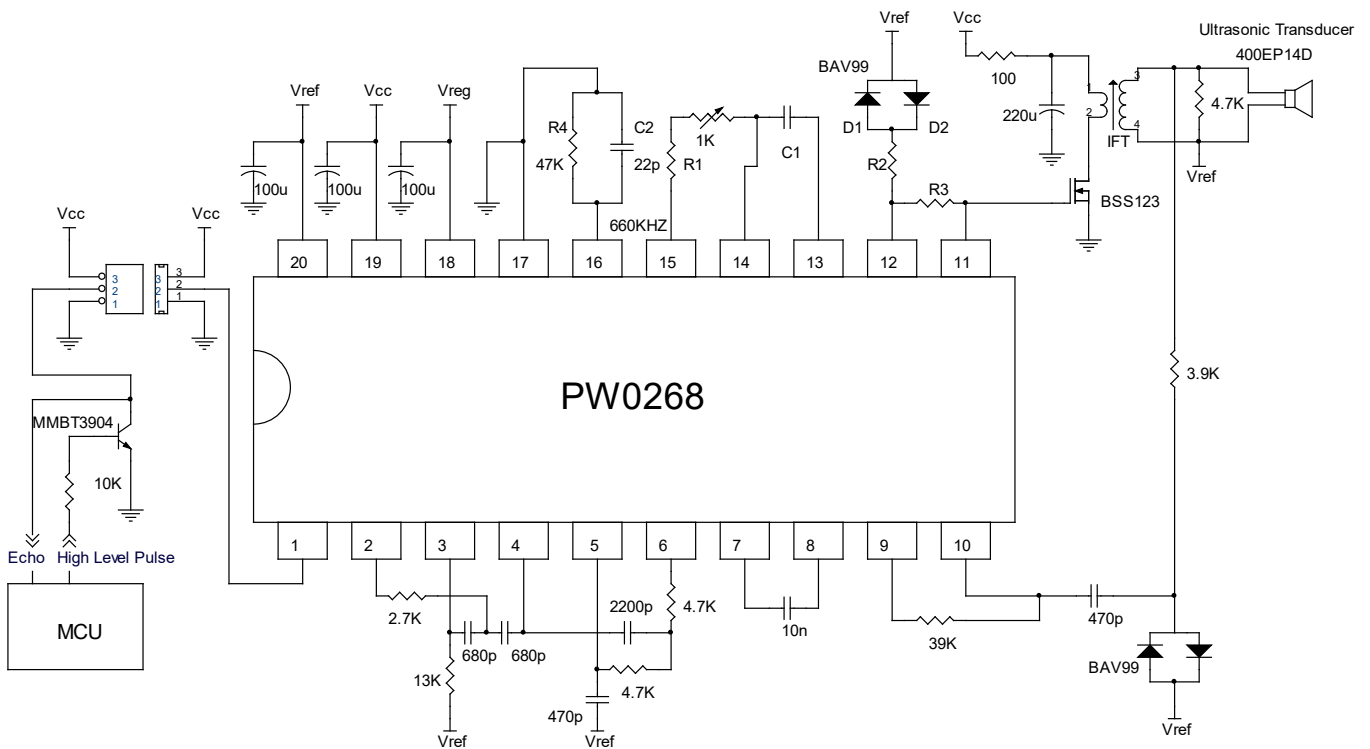

Application Note

The application circuit shown on page 4 is a typical application of car reversing aids. The RC oscillator is activated as a tone burst once a low pulse presents at pin 1 (I_O). Due to the frequency tolerance of ultrasonic transducers the 1K trimmer (R1) tunes oscillation frequency from 38.0 – 42.0 KHz for matching the best operation frequency of transducers. The active burst number equals to the input low pulse width.

The tone burst output at pin 11 (Driver_O) switches MOSFET to drive transducer thru the matching IFT, which plays as an impedance bridge between driving source and loaded transducers and its secondary inductance tunes out the reactance of the parallel capacitance of transducers.

The driving tone burst and returned echoes will be firstly chopped by two diodes and then, be amplified by the pre-amplifier and successive the 2nd fixed gain amplifier, a 32 steps time controlled gain amplifier. The gain of pre-amplifier should be set properly to meet sensitivity of used transducers and application requirements.

The center frequency of band-pass filter should be designed as exact as the RC oscillation frequency and its pass-band width depends on actual application requirement.

If the level of echo signal presents at filter output is above $0.35V + V_{ref}$, the comparator will output a low pulse at Pin 1 (I_O) with width is proportion to the echo signal strength.

The above description can be summarized as the signal timing charts illustrated as below

MCU output: H: 1ms/Div., V: 2.0V/Div.

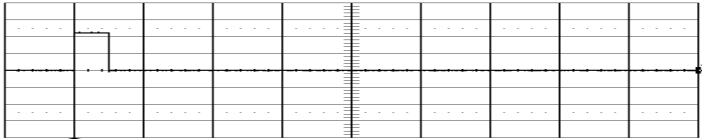

The RC oscillator will be enabled in the duration of input pulse. The maximum pulse width is $396/F$ and any time longer than this upper limit will be ignored.

Driver_O (Pin 11): H: 1ms/Div., V: 2.0V/Div.

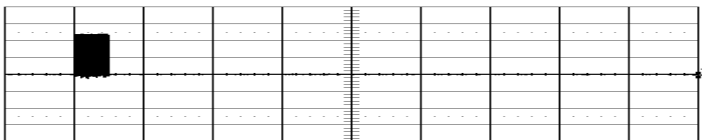

The next input pulse will be ignored if the pulse repetition rate is shorter than $9900/F + \text{pulse width}$.

F: Frequency of system clock

Transducer Oscillation: H: 1ms/Div., V: 50V/Div.

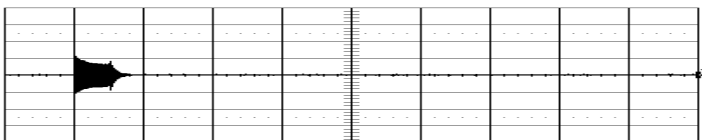

HP_O (Pin 2): H: 1ms/Div., V: 2.0V/Div.

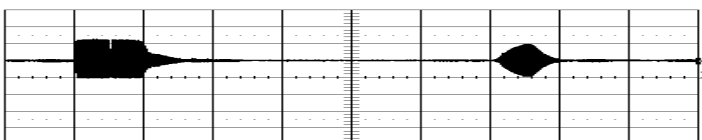

Output at Pin 1 I_O: H: 1ms/Div., V: 5.0V/Div.

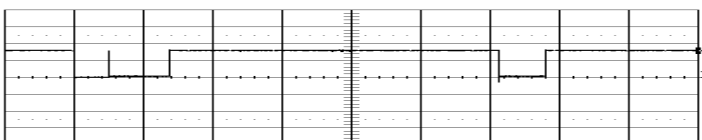

Due to the resonant frequency of ultrasonic transducer is sensitive to temperature, the driving signal mismatches the frequency of transducers when the ambient temperature goes up and down if the oscillation frequency maintains always as constant. In general, the transducer has a negative temperature coefficient, lower temperature higher resonant frequency and higher temperature lower frequency. Therefore, the frequency of driving source is better to trace the transducer frequency at different ambient temperature.

The voltage at pin 11 (Ftrace) varies due to the negative temperature coefficient of DC forward voltage of diodes D1, D2 and the ratio of R2/R3. In low temperature the forward voltage of diodes becomes large than room temperature that leads more square amplitude at pin 15 (ORC3), which accelerates the charging process of integrator and higher frequency output at pin 11 (Driver_O). In the same principle for high temperature, the forward voltage of diodes becomes less than room temperature that slows down the charging process, thus lower frequency output at pin 11 (Driver_O). Selecting suitable values of R1, R2, R3 and C1 tune the slop to meet frequency tracing curve as closer as possible. Recommend values for different transducers please see the table as below.

Used Transducer	R1(Ohm)	R2(Ohm)	R3(Ohm)	C1(pF)
400EP14D	3,300	1,500	511	2,200
400EP18A	3,300	1,500	604	2,200
235AC130	2,000	0	2,100	220

For constant oscillation frequency of 40KHz just simply remove D1, D2 and R2 and set R1 = 4,500 Ohm, C1 = 2,200 pF, R3 = 511 Ohm.

The system clock at pin 16 (CLK) controls the maximum input pulse width, the slop of time controlled gain amplifier and pulse repetition rate.

For example, as the above block diagram shows, the system clock is setting as 660KHz (C2: 22pF, R4: 47K Ohm):

- (1) The input pulse width is no longer than $396/F = 396/660K = 0.6$ ms and any duration longer than 0.6 ms will be ignored.
- (2) The step duration of 32 steps time controlled gain amplifier equals to $220/F = 0.333$ ms, starting from the end of pulse.
- (3) The pulse repetition rate is no shorter than $9900/F + \text{pulse width} = 9900/F + 0.5$ ms (20 bursts of 40KHz) = $9900/660K + 0.5 = 15.5$ ms.

For long measurement distance of 18 meter (one way distance), the system clock should be set as:

Wave Flying Time = $(18 * 2)/340 = 105.9$ ms

Min. Pulse Repetition Rate = $9900/F + 0.75 = 166$ mS (30 bursts of 40KHz)

Frequency of System Clock F = 60 KHz

Detail circuit diagram of 18 meter tape measurement please consult with factory.

Time Controlled Gain Amplifier

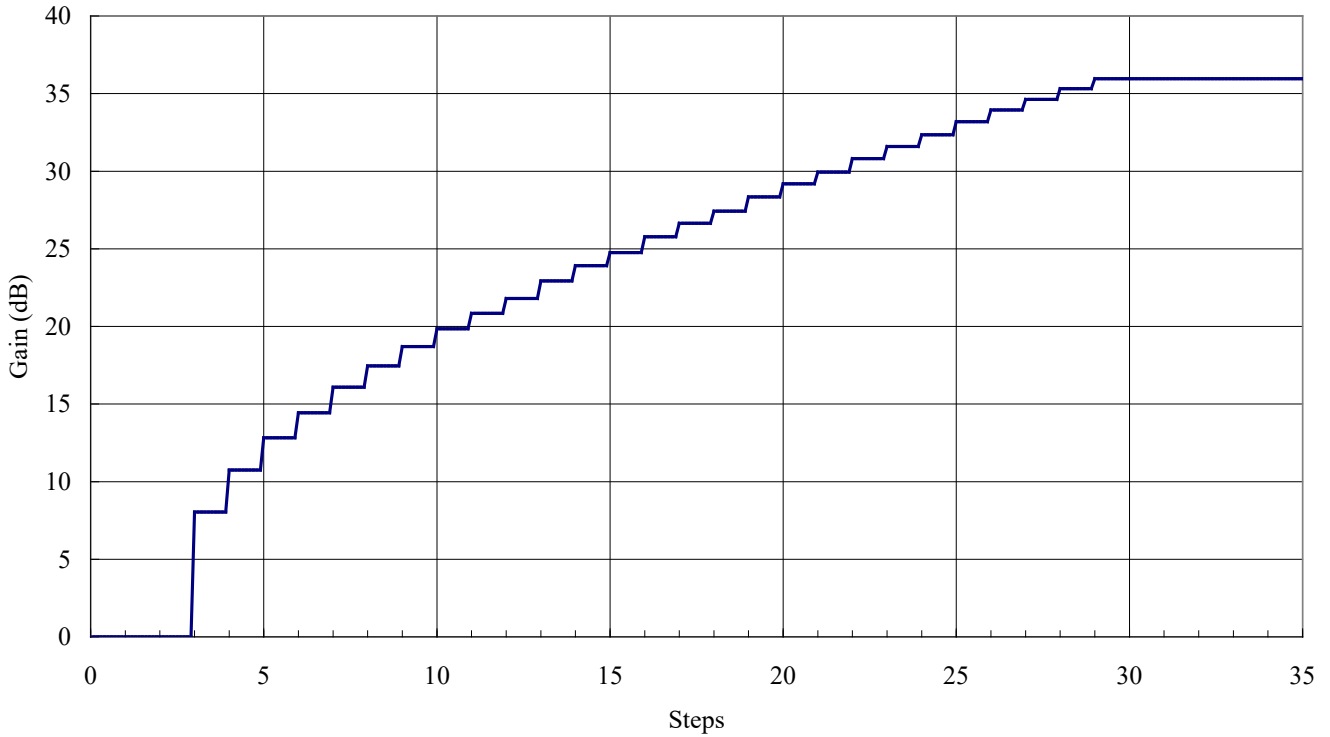

The time controlled gain amplifier is stepping up once the input pulse falling. The time duration can be calculated as:

$$T = 220/F$$

F: Frequency of System Clock

Package and Dimensions:

20 Pins, SSOP (150mil)

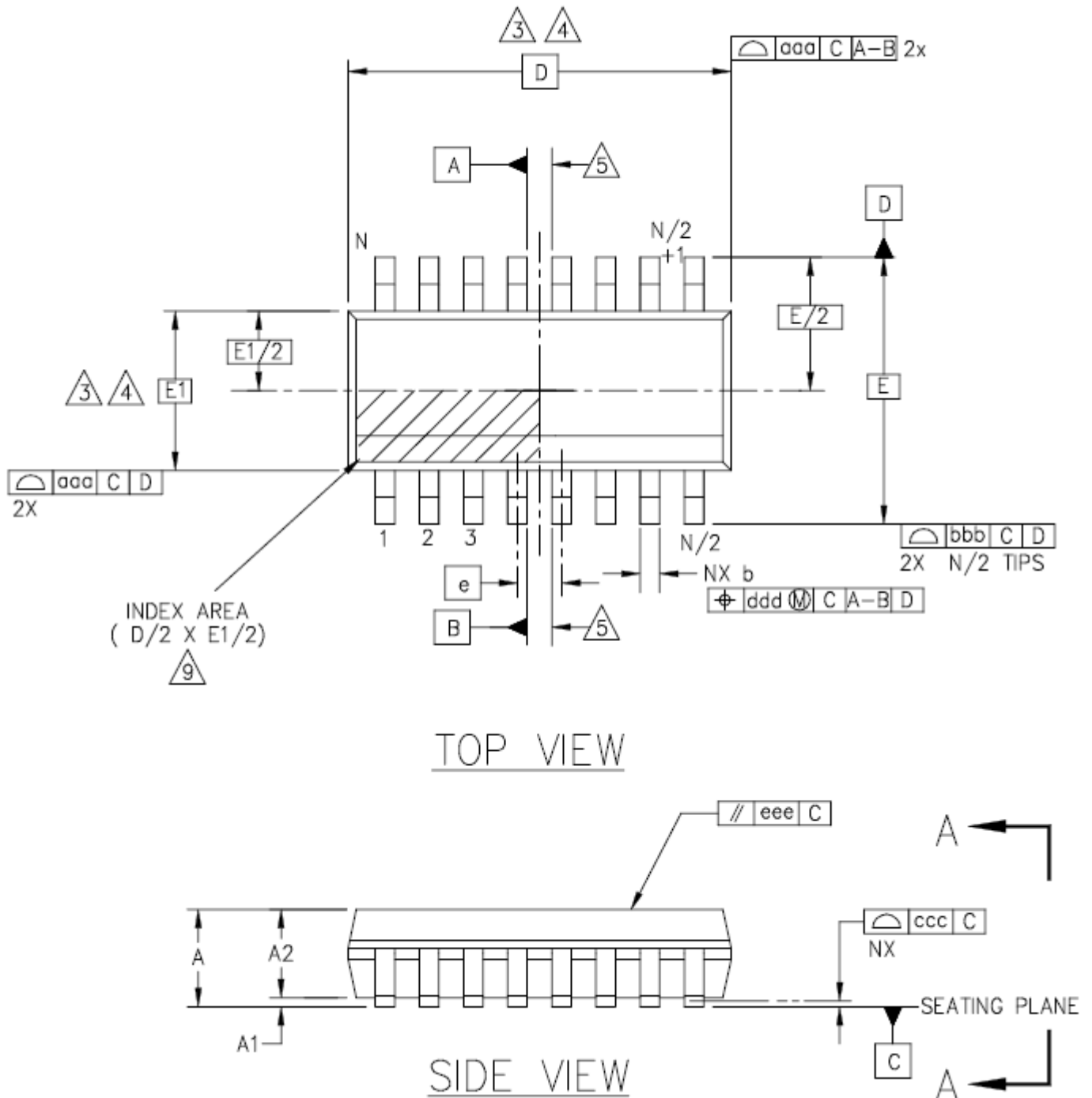

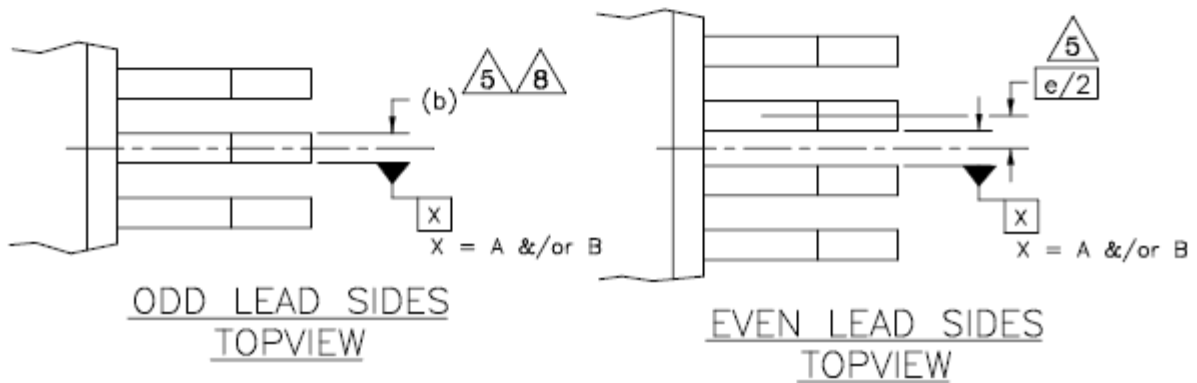
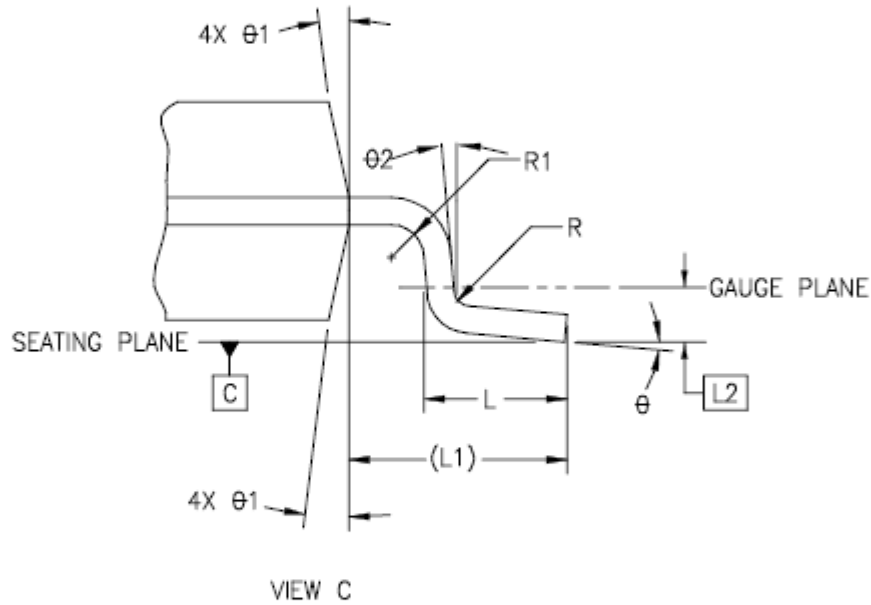
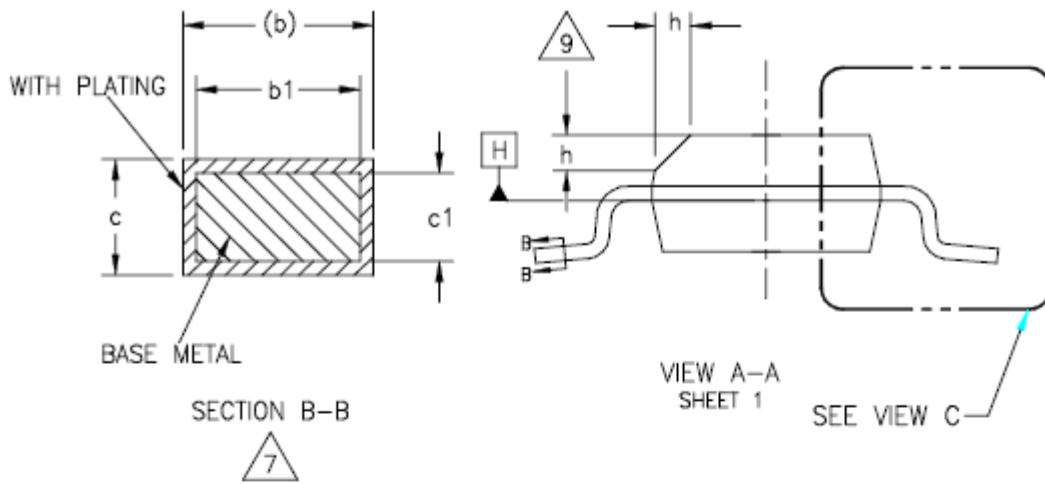

Symbol	Min.	Nom.	Max.
A	0.053	-	0.069
A1	0.004	-	0.010
A2	0.049	-	0.065
b	0.008	-	0.012
b1	0.008	0.010	0.011
c	0.006	-	0.010
c1	0.006	0.008	0.009
D	0.341 BSC		
E	0.236 BSC		
E1	0.154 BSC		
e	0.025 BAS		
L	0.016	-	0.050
L1	0.041 REF		
L2	0.010 BAS		
R	0.003	-	-
R1	0.003	-	-
θ	0°	-	8°
θ1	5°	-	15°
θ2	0°	-	-
aaa	0.004		
bbb	0.008		
ccc	0.004		
ddd	0.007		
eee	0.004		

Notes:

1. Dimensioning and tolerancing per ANSI Y14.5M-1982.
2. Dimensions in inches (angles in degrees)
3. Dimension D does not include mold flash, protrusions or gate burrs. Mold flash, protrusions or gate burrs shall not exceed 0.006" per end. Dimension E1 does not include interlead flash or protrusions. Interlead flash or protrusions shall not exceed "0.006" per side. D1 and E1 dimensions are determined at datum H.
4. The package top may be smaller than the package bottom. Dimensions D and E1 are determined at the outermost extremes of the plastic body exclusive of mold flash, tie bar burrs, gate burrs and interlead flash, but including any mismatch between the top and bottom of the plastic.
5. Datum A and B to be determined at datum H.
6. N is the maximum number of terminal position. (N=20)
7. The dimensions apply to the flat section of the lead between 0.004 to 0.010 inches from the lead tip.
8. Dimension b does not include dambar protrusion. Allowable dambar protrusion shall be 0.004" total in excess of b dimension at maximum material condition. The dambar can not be located on the lower radius of the foot.
9. Refer to JEDEC MO-137 variation AD.

JEDEC is the registered trademark of JEDEC SOLID STATE TECHNOLOGY ASSOCIATION