

Multimec™ 5E

High performance tactile switches •
MIL-PRF-28855H



DISTINCTIVE FEATURES

- Momentary switches with NO or NC/NO function
- Sealed to IP67
- Robust
- Anti-rotation thanks to snap-on cap retention system
- 3 standard actuation forces: 2.0, 3.5 and 6.5 N



ENVIRONMENTAL SPECIFICATIONS

- Sealing : IP67 according to IEC 60529
- Working and storage temperature : -40 °C/+160 °C (-40 °F to +320 °F)
- Soldering :
 - through-hole : IEC 60068-2-20 8
 - surface mount : JEDEC J-STD-020E



ELECTRICAL SPECIFICATIONS

- Recommended load :
 - Gold contacts : 0.5µ-50 mA 24 VDC
 - Silver contacts : 0.5-50 mA 24 VDC
- Contact resistance : <30 mΩ - typically 10 mΩ
- Insulation resistance : >10 MΩ
- Contact bounce : <2 mS - typically 0.5 mS



MECHANICAL SPECIFICATIONS

- Standard actuation force :
 - momentary NO : 2.0 N, 3.5 N, 6.5 N
 - quiet version : 2.0 N
 - NC/NO function : 3.5 N
- Max. actuation force :
 - momentary : 115 N for 60 sec (according to MIL-PRF-22885H)
 - NC/NO : 100 N for 10 sec
- Travel : 1 mm
- Lifetime :
 - NO : >10,000,000 cycles
 - NC/NO : >1,000,000 cycles

The company reserves the right to change specifications without notice.



MATERIALS

- Housing : PPS UL94V0
- Actuator : PPS UL94V0
- Sealing : Silicone rubber
- Contacts spring : Stainless steel
 - Silver : +3 µAg
 - Gold : +1 µAu
- Fixed contacts :
 - Silver : SnCu + 2 µNi + 3 µAg
 - Gold : SnCu + 2 µNi + 1 µAu
- Terminals : SnCu + 2 µNi + 3 µSn100

All tolerance if not otherwise specified ±0.2 mm.

Multimec™ 5E

High performance tactile switches • MIL-PRF-28855H

5E

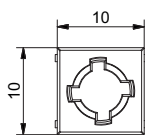

- SMD, TH or right angle TH
- NO or NC/NO

All tolerances unless otherwise noted : ± 0.2 mm

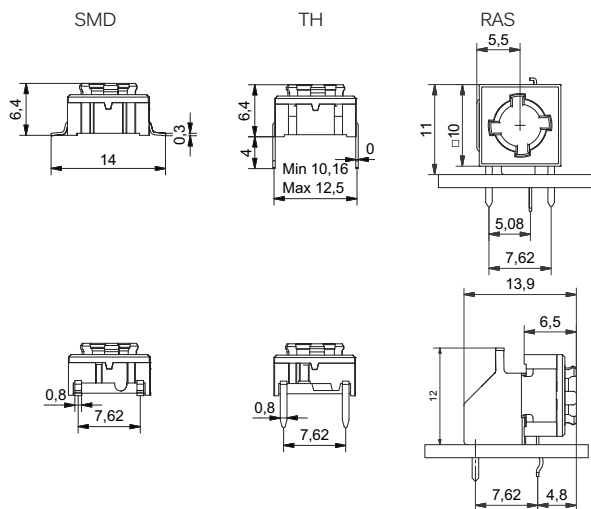

PCB LAYOUT & CIRCUIT DIAGRAM

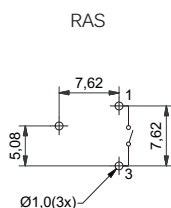
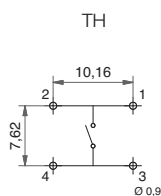
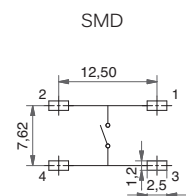

NC/NO function
*not for sale in Japan

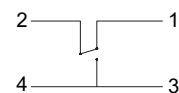



BUILD YOUR PART NUMBER

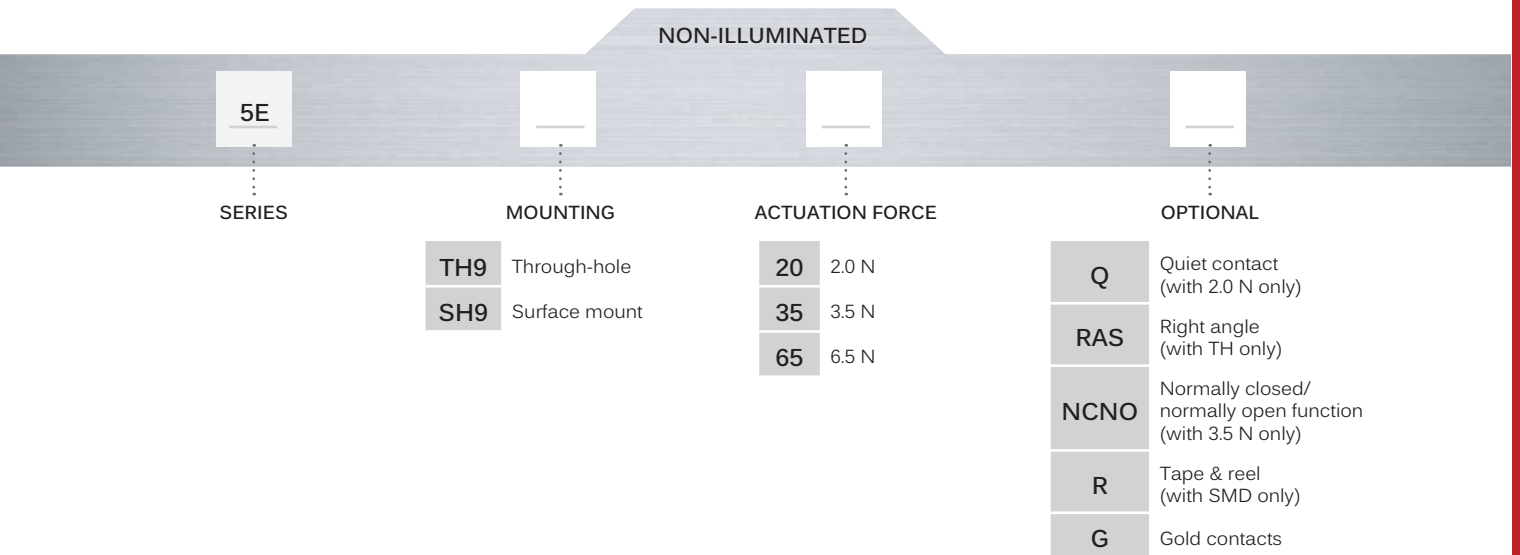

ABOUT THIS SERIES

Laser marking on the switch for identification : WWYS, WW=week, Y=year, S=suffix for the type of switch, e.g. P=2.0 N and silver contacts, S=3.5 N and silver contacts, E6.5 N and silver contacts

Caps : see www.apem.com for more information.

Multimec™ 5E

High performance tactile switches •
MIL-PRF-28855H



TAPE & REEL

Tape and reel is available for the parts listed and has the following specifications

- Reel diameter: Ø330 mm
- Tape width: 24 mm
- Pitch: see list
- Tape and reel material: antistatic or better
- Quantity per reel: see list

PART NO.	ORDERING CODE	PITCH	QUANTITY PER REEL
5ESH9XX	5ESH9XXR	16	500
5ESH9XX1SSXX-08.0	5ESH9XXR1SSXX-08.0	20	250
5ESH9XX1SSXX-09.5	5ESH9XXR1SSXX-09.5	20	250
5ESH9XX1SSXX-10.4	5ESH9XXR1SSXX-10.4	20	250
5ESH9XX1SSXX-11.0	5ESH9XXR1SSXX-11.0	20	250
5ESH9XX1SSXX-12.0	5ESH9XXR1SSXX-12.0	20	250



OPERATING FORCE

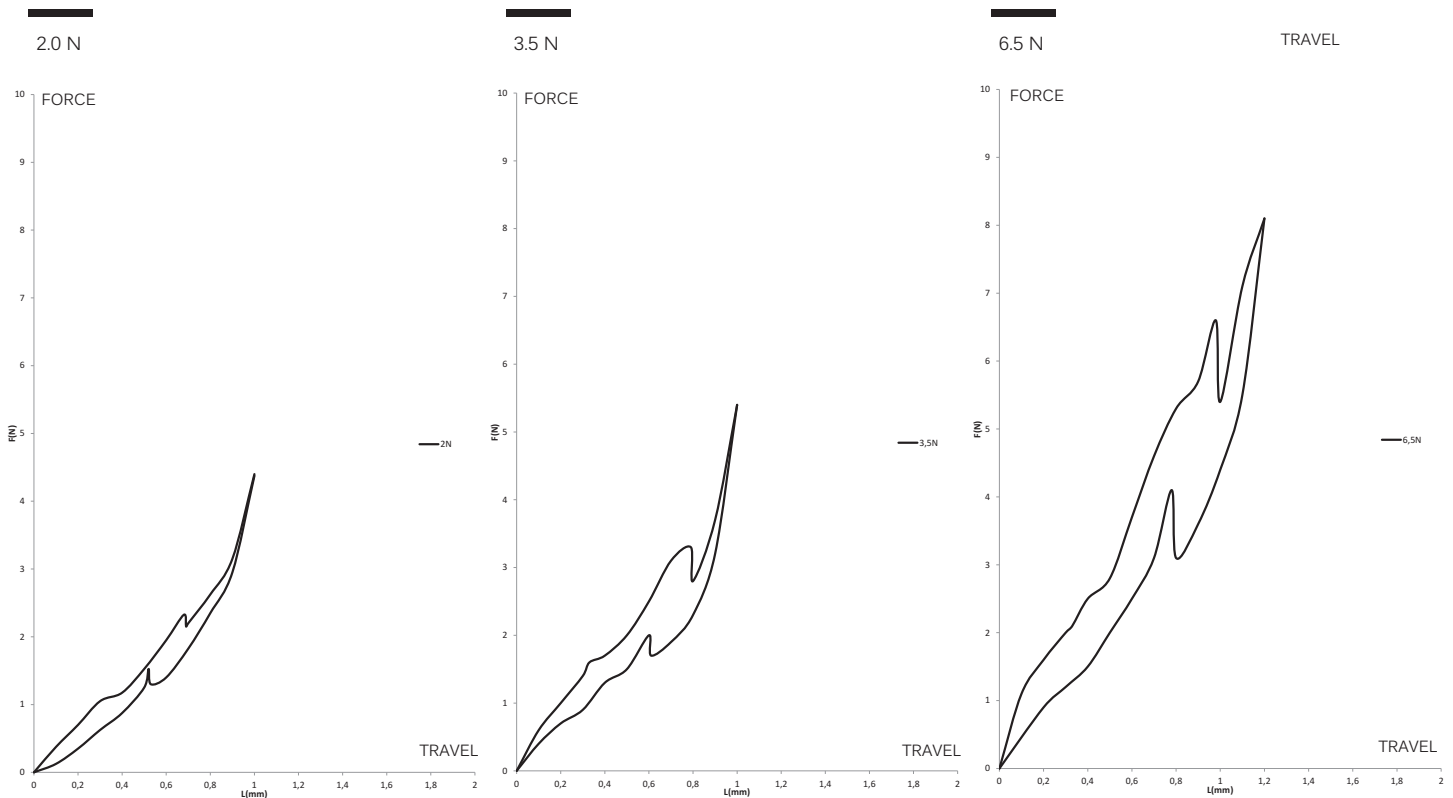



MOUNTING

MOUNTING TOOLS FOR MULTIMEC™ THROUGH-HOLE SWITCHES

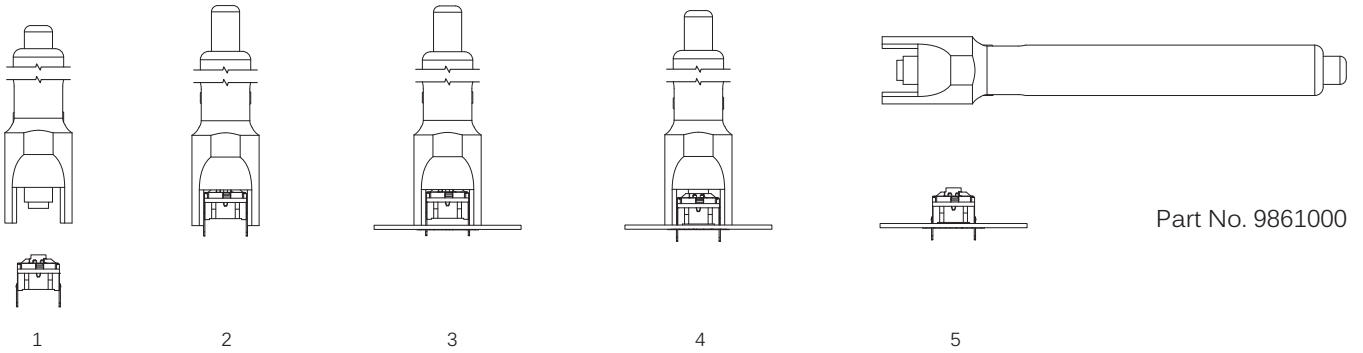

SPACE REQUIREMENT - MATRIX MOUNTING

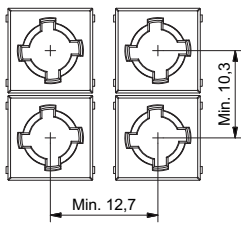

Through-hole (TH)

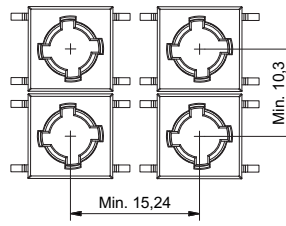

Surface mount (SMD)

CAP SERIES	RECOMMENDED MIN. SWITCH SPACING AxB	NOMINAL CAP DIMENSION WxH	RECOMMENDED MIN. PANEL CUT-CUT
1PS	12.7x10.3	6.5x12.5	7.0x13.0, R max. 1.0
1SS	12.7x10.3	Ø6.5	Ø7.0
1YS/1YAS	15.3x15.3	15.0x15.0	16.0x16.0
1Z/1ZW	35.5x35.5; 41.6x41.6	Ø29.5	Ø30.3
10A+10AWY	22.0x40.0	R=5.3; 10.6x28.0	R=5.5; 11.0x28.4

Multimec™ 5E

High performance tactile switches •
MIL-PRF-28855H



USAGE GUIDELINES

HOW TO GET THE BEST RESULTS WITH MEC SWITCHES ?

These guidelines are offered to users of MEC Switches as an aid to ensure successful and reliable switch operation. Please see the technical specifications for details on operating and storage temperatures and soldering guidelines to make sure you select the best switch for your application. When reflow soldering is taking place, MEC strongly recommend that the temperature profile is analyzed and compared with the temperature rating of the switch. It is also important to monitor the accumulated heat buildup from both the pre-heat zones and the solder zone.

Most standard accessories for multimec™ 5 series switches are made from ABS plastic with a maximum operating temperature of 65 °C. It is strongly recommended that accessories are mounted after soldering of the switch. If this is not possible care must be taken not to overheat the accessories during the soldering process. The 1SS caps are, however, made of high temperature materials and will meet the same temperature specifications as the switches. For accessories made from other plastic materials please see multimec™ 5 series cap & bezel specifications.

MOUNTING AND DISMOUNTING

If switches are to be mounted in rows it is essential that the recommendations regarding spacing are followed. PC board thickness should be 1.4 ±0.2 mm and terminal hole diameter should be 0.9 mm.

All multimec™ 5 series caps are easily snapped onto the switch modules and can be changed at a later time.

A mounting tool is available for through hole multimec™ 5 series switches.

SOLDERING AND CLEANING MULTIMEC™ SERIES

Multimec™ 5 series switches are fully sealed to IP67 specifications to minimize solder flux and aqueous based cleaning solutions from entering the switch and contaminating the contacts. The switches can be placed on the PC board with other components and reflow soldered. Multimec™ 5 series offers a high level of sealing, however, with aqueous solvent solutions care must be taken to avoid the worst case situation with water jets, complete immersion into a liquid with a temperature below the board or surface tension reducing additives.

Recommended cleaning methods are demineralized water. Any surface tension reducing agents, such as soap, must not be used as they risk causing a potential leakage of the switch.

SOLDERING - THROUGH HOLE VERSIONS

Hand soldering: max. 350 °C for max. 3 sec

Wave soldering: heat built up in the switch during pre-heating and soldering must not exceed the maximum operating temperature of the switch. Peak temperature must not exceed 260 °C, and soldering time is max 10 sec. (IEC 600-68-2-20 8)

SOLDERING - SURFACE MOUNT VERSIONS

For all methods - infrared, convection and vapor phase. The upper limit 240 °C/40 sec must be observed. The soldering temperature profile must have moderate temperature gradients. (JEDEC J-STD-020E)

ROHS COMPLIANCE

As of 1 July 2006 MEC has completed the conversion to RoHS compliance. For more info please see our homepage www.apem.com

TEMPERATURE LIMITS:

Switch	160 °C
Accessories	65/85/160 °C

PACKAGING

Multimec™ 5 series switches are packed in rigid tubes of 50 pieces each.

A box contains 1.000 pcs.

The surface mount versions of multimec™ 5E series switches with a height up to 12.5 mm can also be delivered on tape/reel. Each reel contains 250/500 pcs.

Right angle switches are packed into trays. Each tray contains 100 pcs.