

Data sheet | Item number: 216-424

Ferrule; Sleeve for 35 mm² / AWG 2; uninsulated; electro-tin plated; electrolytic copper; gastight crimped; acc. to DIN 46228, Part 1/08.92

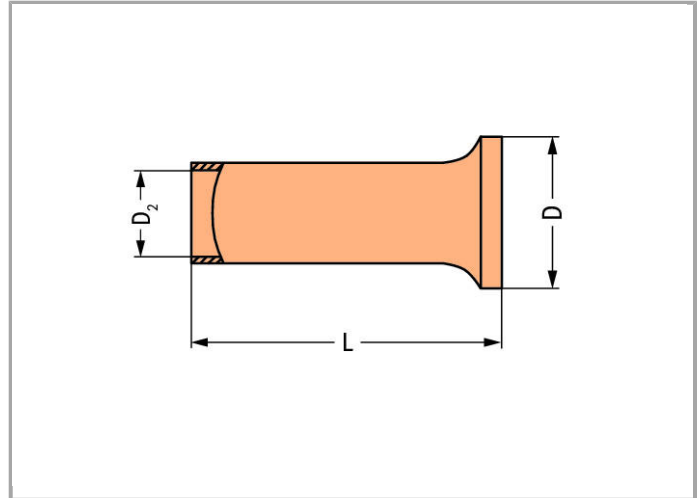

www.wago.com/216-424



Data

Technical Data

Main product function	Ferrule
Querschnitt Hülse AWG	2 AWG
Hülse für	35 mm ²



Connection data

Strip length	30 mm / 1.18 Inch
--------------	-------------------

Geometrical Data

Length	30 mm
Diameter	11 mm
Diameter 2	8.3 mm

Material Data

Weight	9.999 g
--------	---------

Commercial data

Country of origin	DE
GTIN	4050821134190
Customs Tariff No.	85369010000
Product Group	2 (Terminal Block Accessories)

Downloads

Documentation

Bid Text

216-424	Oct 10, 2017	DOC 24.6 kB	Download
---------	--------------	----------------	----------

Subject to changes.