

Technical Data

TRANSISTOR

maximum ratings

Voltage, Collector to Base (VCBO)	36.0	V	NO.	BLY87A
Voltage, Collector to Emitter (VCE)	18.0	V	TYPE	NPN-RF
Voltage, Emitter to Base (VEBO)	4.0	V		
Collector Current (IC)	1.25	A		
Base Current (IB)	0.5	A	CASE	SOT-48_UNF
Max. Power Dissipation (PT) at TC = 25 °C	17.5	W		
Max. Thermal Resistance (Rth J-C)	9.4	°C/W		
Max. Junction Temperature (TJ)	200.0	°C		

PERFORMANCE CHARACTERISTICS at $T_c = 25^\circ\text{C}$, unless otherwise noted

NO.	SYMBOL	CONDITIONS	MIN.	MAX.	UNITS
1.	BVCBO	IC = 1.0 mA	36.0	-	V
2.	BVCEO	IC = 10.0 mA (1)	18.0	-	V
3.	BVEBO	IE = 1.0 mA	4.0	-	V
4.	ICEO	VCE = 14.0 V	-	5.0	mA
5.	hFE	IC = 0.5 A, VCE = 5.0 V (1)	5.0	100.0	-
6.	fT	IC = 0.5 A, VCE = 10.0 V (2)	700.0	-	MHz
7.	Cobo	VCB = 15.0 V, f = 1.0 MHz	-	20.0	pF
8.	PIN	VCE = 13.5 V, Pout = 8.0 W, f = 175.0 MHz	-	1.0	W
9.	GPE	VCE = 13.5 V, Pout = 8.0 W, f = 175.0 MHz	9.0	-	dB
10.	η	VCE = 13.5 V, Pout = 8.0 W, f = 175.0 MHz	70.0	-	%
11.					
12.					
13.					
14.					
15.					
16.					
17.					
18.					
19.					
20.					

Notes (1) pulse-tested $t_p \leq 300 \mu\text{s}$, duty cycle $\leq 2\%$
(2) typical value

DIMENSIONS
in mm

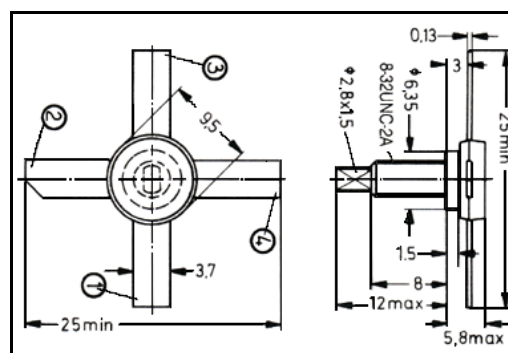

Marking BLY87A
Customer GENERAL PURPOSE