

NUMBER
178289



METRIC

PROJ. NO. 393-620
PROJ. NO. 392-603

PRINT DIST
単位 概 DIMENSIONS IN MM. DO NOT SCALE PRINT

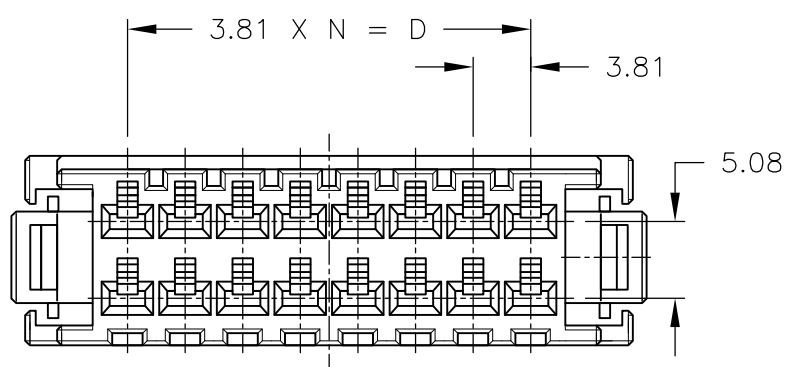
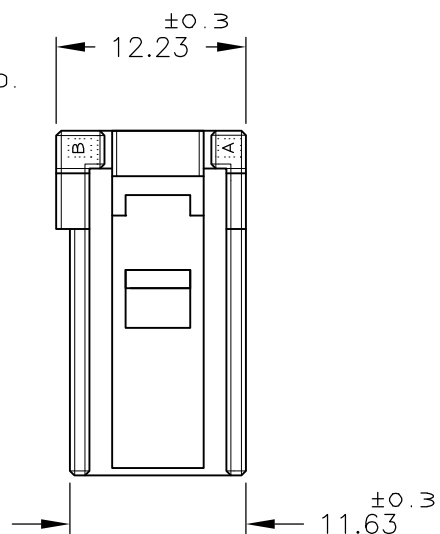
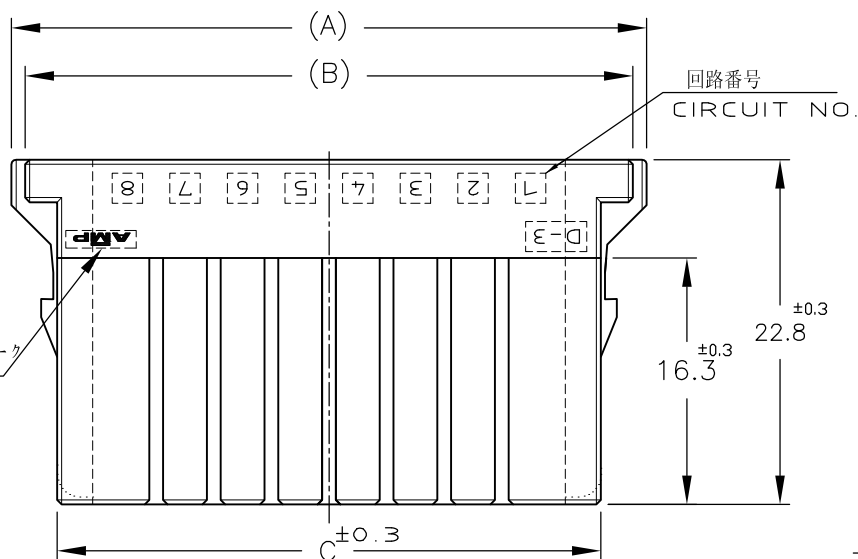
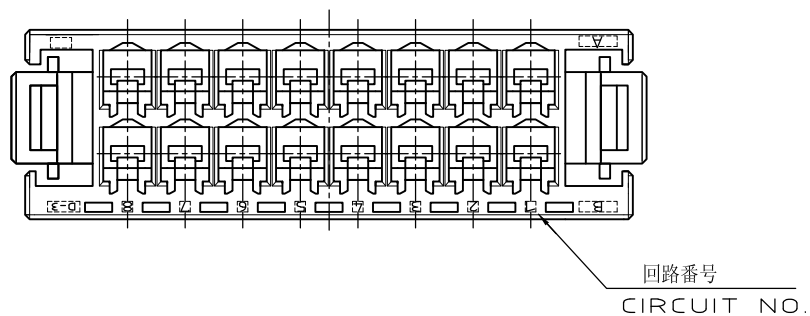

NOTE

- 1 MATERIAL: GLASS FIELD THERMO PLASTIC, POLYESTER
COLOR: BLACK
- ~~2 TO COAT ALL SURFACE OF HOUSING WITH TEFLON~~
- 3 THE SHAPE, SIZE AND POSITION OF THE CHARACTER
SHOW THE OUTLINE THEY DON'T SHOW DETAILS

注記

- 1 材料: ガラス入り熱可塑性ポリエステル樹脂
色: 黒色
- ~~2 ハウジング全面にテフロン塗装のこと~~
- 3 文字の形状、大きさ、および位置については、大略を示すものであり、
詳細を示すものではありません。

		20 POS.	51.03	47.83	43.37	34.29	9	0-178289-8		
OBSOLETE	2	16 POS.						5-178289-7		
		16 POS.		SEE SHEET	20F2			0-178289-7		
		12 POS.	35.79	32.59	28.13	19.05	5	0-178289-6		
OBSOLETE	2	10 POS.	31.98	28.78	24.32	15.24	4	5-178289-5		
		10 POS.	31.98	28.78	24.32	15.24	4	0-178289-5		
		8 POS.	28.17	24.97	20.51	11.43	3	0-178289-4		
OBSOLETE	2	6 POS.	24.36	21.16	16.70	7.62	2	5-178289-3		
		6 POS.	24.36	21.16	16.70	7.62	2	0-178289-3		
	FINISH	POS.	DIMENSION		A	B	C	D	N	PART NUMBER

					TE TE Connectivity					
					抱合電線断面(WIRE RANGE) mm ² (AWG -)					
					被覆外径(INSULATION DIA.) mmφ					
					名稱(NAME) REC HSG FOR DYNAMIC, DOUBLE ROW ダイナミック3100リセハウジング					
					材料(MATERIAL) SEE NOTE 注記参照					
					仕上(FINISH)					
					一般公差 (GENERAL TOLERANCE)					
					10以下 ±0.2 10以上 30以下 ±0.25 30以上 100以下 ±0.3 角度: ±3°					
					SIZE LOC 番号(No.) A3 J C-178289					
					尺度(SCALE) REV. SHEET 2-1 C7 1 OF 2					
C7	REVISED PER ECO-11-005030	RK	HMR	21MAR11	DR.	9 JUL 91 N. Matsubara	DE.	9 JUL 91 N. Matsubara		
LTR	変更 (REVISION RECORD)	DR	CHK	DATE	CHK.	24 FEB. '92 H. Obata	APP.	4 MAR. '92 S. MANABE		

178289

NUMBER



METRIC

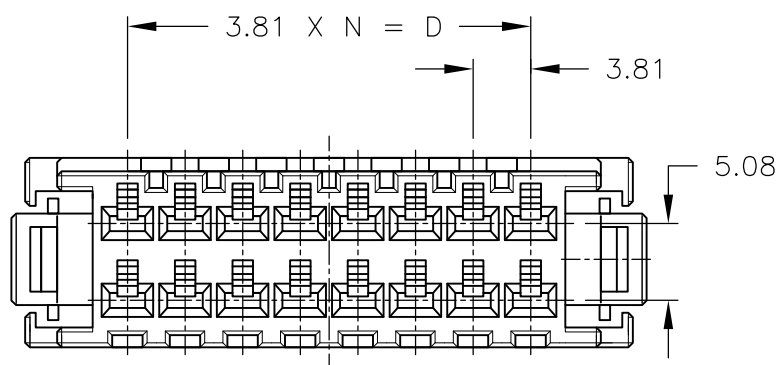
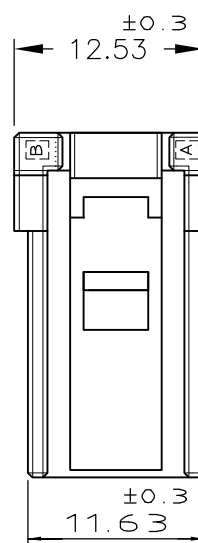
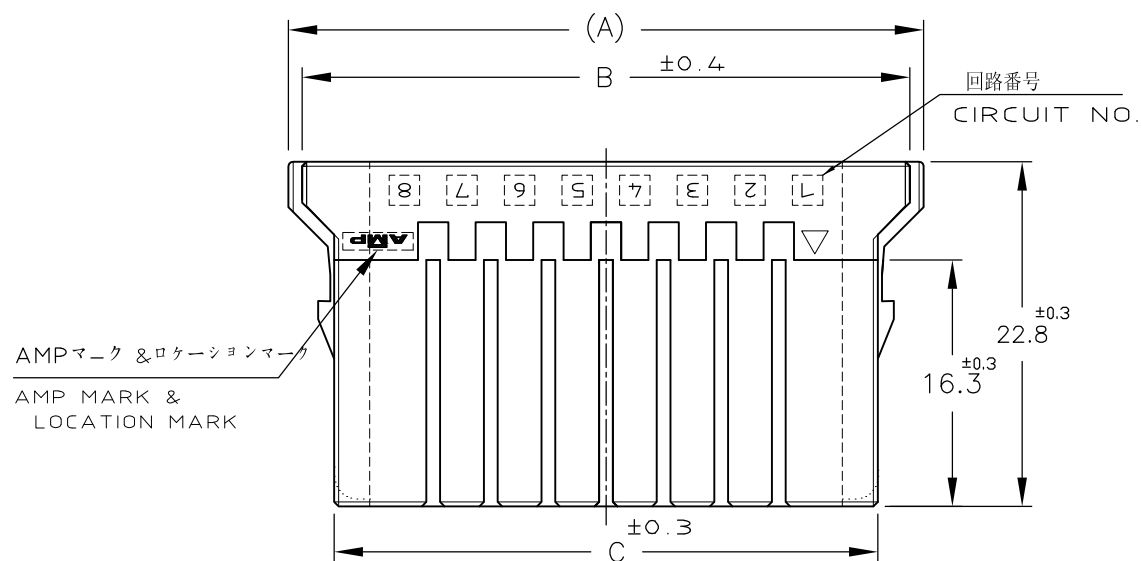
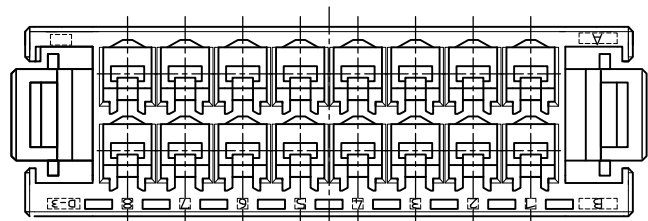

NOTE:SEE SHEET 1 OF 2

OBSOLETE	\triangle											5-178289-7
		16POS	42.71	40.21	35.97	26.67	7					0-178289-7
	FINISH	POS.	DIMENTION		A	B	C	D	N	PART NUMBER		

				TE TE Connectivity				
抱合電線断面(WIRE RANGE)		被覆外径(INSULATION DIA.)		名称(NAME)				
mm ² (AWG -)		mm ϕ		REC HSG FOR DYNAMIC,DOUBLE ROW ダイナミック3100リセハウジング				
材料(MATERIAL)		仕上(FINISH)		一般公差 (GENERAL TOLERANCE)		SIZE	LOC	番号(No.)
DR.		DE.		10以下 : ±0.2		A3	J	C-178289
SEE 1 OF 2		SEE 1 OF 2		10以上 30以下 : ±0.25		尺度(SCALE)		REV.
LTR	変更 (REVISION RECORD)	DR	CHK	DATE	CHK.	APP.	2-1	C7
						30以上 100以下 : ±0.3		SHEET
						角度 : ±3'		2 OF 2

(CUSTOMER DRAWING) 顧客用図面

PRINT DIST 単位 概 DIMENSIONS IN MM. DO NOT SCALE PRINT