



CIRCUIT-BREAKER SZ S0, FOR MOTOR PROTECTION, CLASS 10, W. OVERLOAD RELAY FUNCTION A-RELEASE 10...16A, N-RELEASE208A, SCREW CONNECTION, STANDARD SW. CAPACITY

product brand name		SIRIUS
Product designation		3RV2 circuit breaker

General technical data:		
Active power loss total typical	W	7
Insulation voltage		
• with degree of pollution 3 Rated value	V	690
Shock resistance		
• acc. to IEC 60068-2-27		25g / 11 ms
Surge voltage resistance Rated value	kV	6
Mechanical service life (switching cycles)		
• of the main contacts typical		100 000
• of the auxiliary contacts typical		100 000
Electrical endurance (switching cycles)		
• typical		100 000
Temperature compensation	°C	-20 ... +60
Size of contactor can be combined company-specific		S0
Protection class IP		
• on the front		IP20
• of the terminal		IP20
Type of protection		Increased safety
Equipment marking		
• acc. to DIN EN 81346-2		Q

Main circuit:		
Number of poles for main current circuit		3

Adjustable response value current of the current-dependent overload release	A	10 ... 16
Operating voltage		
• Rated value	V	690
• at AC-3 Rated value maximum	V	690
Operating frequency Rated value	Hz	50 ... 60
Operating current Rated value	A	16
Operating current		
• at AC-3		
— at 400 V Rated value	A	16
Operating power		
• at AC-3		
— at 230 V Rated value	W	4 000
— at 400 V Rated value	W	7 500
— at 500 V Rated value	W	7 500
— at 690 V Rated value	W	11 000
Operating frequency		
• at AC-3 maximum	1/h	15

Auxiliary circuit:

Number of NC contacts		
• for auxiliary contacts		0
Number of NO contacts		
• for auxiliary contacts		0
Number of CO contacts		
• for auxiliary contacts		0
Product expansion Auxiliary switch		Yes
Design of the auxiliary switch		laterally
Operating current of the auxiliary contacts at AC-15		
• at 24 V	A	1.5
• at 230 V	A	1.5
Operating current of the auxiliary contacts at DC-13		
• at 24 V	A	1

Protective and monitoring functions:

Trip class		CLASS 10
Design of the overload circuit breaker		thermal
Operational short-circuit current breaking capacity (Ics) with AC		
• at 240 V Rated value	kA	100
• at 400 V Rated value	kA	25
• at 500 V Rated value	kA	5
• at 690 V Rated value	kA	2
Maximum short-circuit current breaking capacity (Icu)		

<ul style="list-style-type: none"> • with AC at 240 V Rated value • with AC at 400 V Rated value • with AC at 500 V Rated value • with AC at 690 V Rated value 	kA	100
	kA	55
	kA	10
	kA	4
Breaking capacity short-circuit current (I_{cn})		
<ul style="list-style-type: none"> • with 1 current path for DC at 150 V Rated value 	kA	10
<ul style="list-style-type: none"> • with 2 current paths in series for DC at 300 V Rated value 	kA	10
<ul style="list-style-type: none"> • with 3 current paths in series for DC at 450 V Rated value 	kA	10
Response value current of the instantaneous short-circuit release	A	208

UL/CSA ratings:

Full-load current (FLA) for three-phase AC motor		
<ul style="list-style-type: none"> • at 480 V Rated value 	A	16
<ul style="list-style-type: none"> • at 600 V Rated value 	A	16
yielded mechanical performance [hp]		
<ul style="list-style-type: none"> • for single-phase AC motor at 110/120 V Rated value 	metric hp	1
<ul style="list-style-type: none"> • for single-phase AC motor at 230 V Rated value 	metric hp	2
<ul style="list-style-type: none"> • for three-phase AC motor at 200/208 V Rated value 	metric hp	3
<ul style="list-style-type: none"> • for three-phase AC motor at 220/230 V Rated value 	metric hp	5
<ul style="list-style-type: none"> • for three-phase AC motor at 460/480 V Rated value 	metric hp	10
Contact rating of the auxiliary contacts acc. to UL		C600 / R300

Short-circuit:

Product function Short circuit protection		Yes
Design of the short-circuit trip		magnetic
Design of the fuse link		
<ul style="list-style-type: none"> • for short-circuit protection of the auxiliary switch required 		fuse gL/gG: 6 A, quick: 10 A
Design of the fuse link for IT network for short-circuit protection of the main circuit		
<ul style="list-style-type: none"> • at 400 V • at 500 V • at 690 V 		gL/gG 63 A gL/gG 50 A gL/gG 40 A

Installation/ mounting/ dimensions:

mounting position		any
Mounting type		screw and snap-on mounting onto 35 mm standard mounting rail according to DIN EN 60715

Height	mm	97
Width	mm	65
Depth	mm	96
Required spacing		
<ul style="list-style-type: none"> • with side-by-side mounting <ul style="list-style-type: none"> — forwards — Backwards — upwards — downwards — at the side • for grounded parts <ul style="list-style-type: none"> — forwards — Backwards — upwards — at the side — downwards • for live parts <ul style="list-style-type: none"> — forwards — Backwards — upwards — downwards — at the side 	mm	0 0 50 50 0 0 0 50 30 50 0 0 50 50 30

Connections/ Terminals:		
Type of electrical connection		
<ul style="list-style-type: none"> • for main current circuit • for auxiliary and control current circuit 		screw-type terminals screw-type terminals
Arrangement of electrical connectors for main current circuit		Top and bottom
Product function		No
<ul style="list-style-type: none"> • removable terminal for auxiliary and control circuit 		
Type of connectable conductor cross-section		
<ul style="list-style-type: none"> • for main contacts <ul style="list-style-type: none"> — single or multi-stranded — finely stranded with core end processing • for AWG conductors for main contacts • for auxiliary contacts <ul style="list-style-type: none"> — single or multi-stranded — finely stranded with core end processing • for AWG conductors for auxiliary contacts 		2x (1 ... 2,5 mm ²), 2x (2,5 ... 10 mm ²) 2x (1 ... 2.5 mm ²), 2x (2.5 ... 6 mm ²), 1x 10 mm ² 2x (16 ... 12), 2x (14 ... 8) 2x (0,5 ... 1,5 mm ²), 2x (0,75 ... 2,5 mm ²) 2x (0.5 ... 1.5 mm ²), 2x (0.75 ... 2.5 mm ²) 2x (20 ... 16), 2x (18 ... 14)
Tightening torque		
<ul style="list-style-type: none"> • for main contacts with screw-type terminals 	N·m	2 ... 2.5

Design of screwdriver shaft		Diameter 5 to 6 mm
Design of the thread of the connection screw		
<ul style="list-style-type: none"> • for main contacts 	%	M4
<ul style="list-style-type: none"> • of the auxiliary and control contacts 	%	M3

Safety related data:

B10 value with high demand rate acc. to SN 31920		50 000
Proportion of dangerous failures		
<ul style="list-style-type: none"> • with low demand rate acc. to SN 31920 	%	40
<ul style="list-style-type: none"> • with high demand rate acc. to SN 31920 	%	40
Failure rate [FIT] with low demand rate acc. to SN 31920	FIT	50
T1 value for proof test interval or service life acc. to IEC 61508	y	10
Protection against electrical shock		finger-safe

Mechanical data:

Size of the circuit-breaker		S0
------------------------------------	--	----





Ambient conditions:

Installation altitude at height above sea level maximum	m	2 000
Ambient temperature		
<ul style="list-style-type: none"> • during operation 	°C	-20 ... +60
<ul style="list-style-type: none"> • during storage 	°C	-50 ... +80
<ul style="list-style-type: none"> • during transport 	°C	-50 ... +80
Relative humidity during operation	%	10 ... 95



Display:

Display version		
<ul style="list-style-type: none"> • for switching status 		Handle

Certificates/ approvals:

General Product Approval			Declaration of Conformity	Test Certificates	
 CCC	 CSA		 EG-Konf.	Special Test Certificate	Type Test Certificates/Test Report

Shipping Approval					
 ABS	 BUREAU VERITAS	 DNV	 GL	 LRS	 PRS

Shipping Approval		other			
 RINA	 RMRS	Confirmation	Environmental Confirmations	 VDE	other

Further information

Information- and Downloadcenter (Catalogs, Brochures,...)

<http://www.siemens.com/industrial-controls/catalogs>

Industry Mall (Online ordering system)

<http://www.siemens.com/industrymall>

Cax online generator

<http://support.automation.siemens.com/WW/CAXorder/default.aspx?lang=en&mlfb=3RV21214AA10>

Service&Support (Manuals, Certificates, Characteristics, FAQs,...)

<http://support.automation.siemens.com/WW/view/en/3RV21214AA10/all>

Image database (product images, 2D dimension drawings, 3D models, device circuit diagrams, EPLAN macros, ...)

http://www.automation.siemens.com/bilddb/cax_de.aspx?mlfb=3RV21214AA10&lang=en

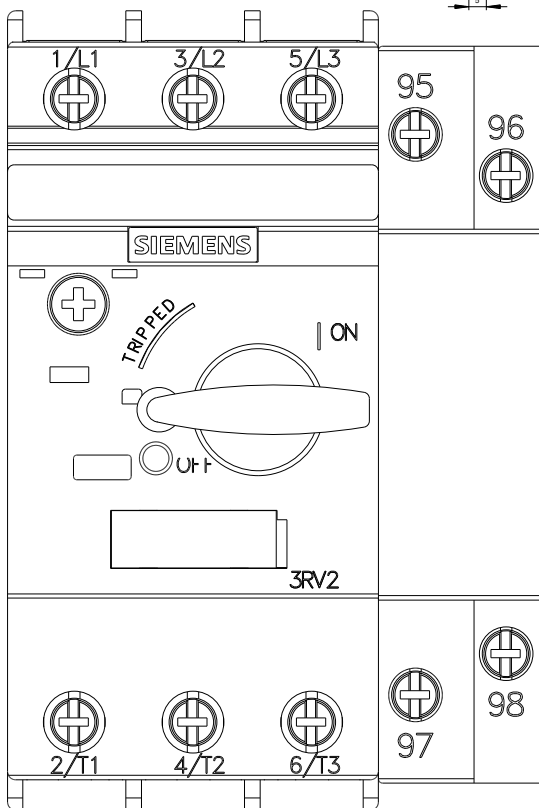
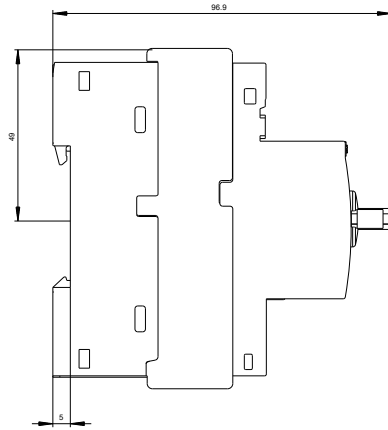
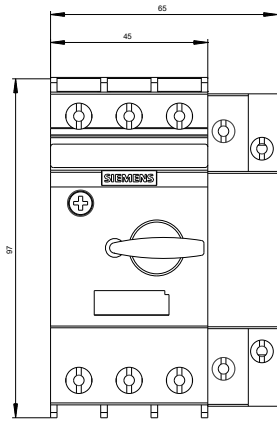

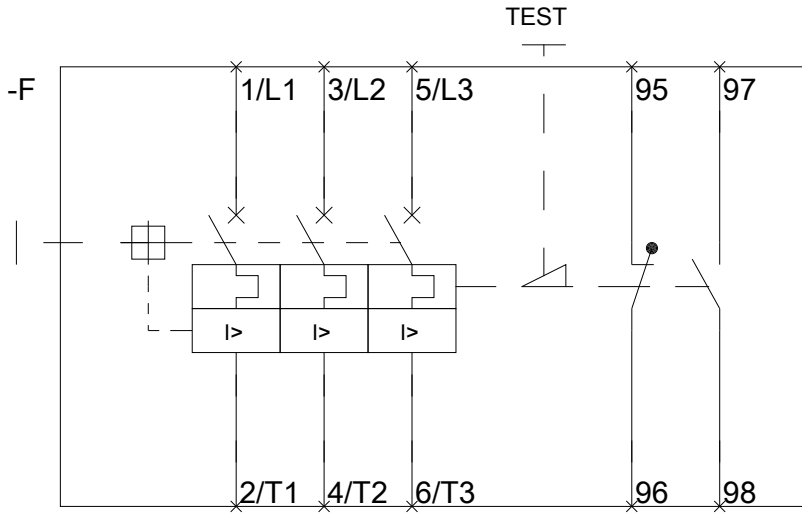

last modified:

11.03.2015