

Cree® 5-mm Red and Amber Round LED

C503B-RAS/RAN/AAS/AAN
C503B-RBS/RBN/ABS/ABN
C503B-RCS/RCN/ACS/ACN

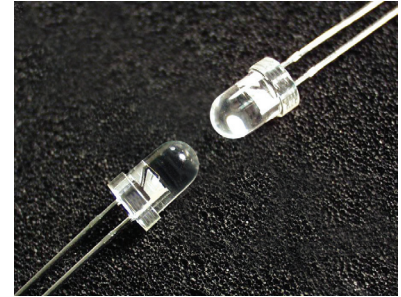

PRODUCT DESCRIPTION

Round LEDs offer superior light output for excellent readability in sunlight and dependable performance. They provide extremely stable light output over long periods of time.

These lamps are made with an advanced optical-grade epoxy offering superior high-temperature and high-moisture-resistance performance in outdoor signal and sign applications.

FEATURES

- Size (mm): 5
- Color and Typical Dominant Wavelength:
Red (624nm)
Amber(591nm)
- Luminous Intensity (mcd)
C503B-RAS/RAN:
(5860 - 23500)
C503B-RBS/RBN:
(3000 - 12000)
C503B-RCS/RCN:
(3000 - 12000)
C503B-AAS/AAN:
(5860 - 23500)
C503B-ABS/ABN:
(3000 - 12000)
C503B-ACS/ACN:
(4180 - 12000)
- Viewing angle:
C503B-RAS/RAN/AAS/AAN:
15 degree
C503B-RBS/RBN/ABS/ABN:
23 degree
C503B-RCS/RCN/ACS/ACN:
30 degree
- Lead - Free
- RoHS Compliant

APPLICATIONS

- Electronic Signs & Signals (ESS)
- Motorway Signs
- Variable Message Sign (VMS)
- Advertising signs
- Petrol Signs
- Amusement

ABSOLUTE MAXIMUM RATINGS ($T_A = 25^\circ\text{C}$)

Items	Symbol	Absolute Maximum Rating	Unit
		Red/Amber	
Forward Current	I_F	50 ^{Note1}	mA
Peak Forward Current ^{Note2}	I_{FP}	200	mA
Reverse Voltage	V_R	5	V
Power Dissipation	P_D	130	mW
Operation Temperature	T_{opr}	-40 ~ +100	$^\circ\text{C}$
Storage Temperature	T_{stg}	-40 ~ +100	$^\circ\text{C}$
Lead Soldering Temperature	T_{sol}	Max. 260 $^\circ\text{C}$ for 3 sec. max. (3 mm from the base of the epoxy bulb)	
Electrostatic Discharge Classification (MIL-STD-883E)	ESD	Class 2	

Note:

- For long term performance the drive currents between 10mA and 30mA are recommended. Please contact CREE sales representative for more information on recommended drive conditions.
- Pulse width ≤ 0.1 msec, duty $\leq 1/10$.

TYPICAL ELECTRICAL & OPTICAL CHARACTERISTICS ($T_A = 25^\circ\text{C}$)

Characteristics	Color	Symbol	Condition	Unit	Minimum	Typical	Maximum
Forward Voltage	Red/Amber	V_F	$I_F = 20$ mA	V		2.1	2.6
Reverse Current	Red/Amber	I_R	$V_R = 5$ V	μA			100
Dominant Wavelength	Red	λ_D	$I_F = 20$ mA	nm	618	624	630
	Amber	λ_D	$I_F = 20$ mA	nm	584	591	596
Luminous Intensity	Red	C503B-RAS/RAN (15 degree)	I_V	$I_F = 20$ mA	mcd	5860	12000
		C503B-RBS/RBN (23 degree)	I_V	$I_F = 20$ mA	mcd	3000	5000
		C503B-RCS/RCN (30 degree)	I_V	$I_F = 20$ mA	mcd	3000	5100
	Amber	C503B-AAS/AAN (15 degree)	I_V	$I_F = 20$ mA	mcd	5860	13000
		C503B-ABS/ABN (23 degree)	I_V	$I_F = 20$ mA	mcd	3000	5000
		C503B-ACS/ACN (30 degree)	I_V	$I_F = 20$ mA	mcd	4180	6000
50% Power Angle	C503B-RAS/RAN/AAS/AAN		$2\theta_{1/2}$	$I_F = 20$ mA	deg	15	
	C503B-RBS/RBN/ABS/ABN		$2\theta_{1/2}$	$I_F = 20$ mA	deg	23	
	C503B-RCS/RCN/ACS/ACN		$2\theta_{1/2}$	$I_F = 20$ mA	deg	30	

INTENSITY BIN LIMIT ($I_F = 20 \text{ mA}$)

Red

C503B-RAS/RAN (15 degree)

Bin Code	Min. (mcd)	Max. (mcd)
Y0	5860	8200
Z0	8200	12000
A0	12000	16800
B0	16800	23500

C503B-RBS/RBN (23 degree)

Bin Code	Min. (mcd)	Max. (mcd)
W0	3000	4180
X0	4180	5860
Y0	5860	8200
Z0	8200	12000

C503B-RCS/RCN (30 degree)

Bin Code	Min. (mcd)	Max. (mcd)
W0	3000	4180
X0	4180	5860
Y0	5860	8200
Z0	8200	12000

- Tolerance of measurement of luminous intensity is $\pm 15\%$

COLOR BIN LIMIT ($I_F = 20 \text{ mA}$)

Red

Bin Code	Min. (nm)	Max. (nm)
RA	618	630

- Tolerance of measurement of dominant wavelength is $\pm 1 \text{ nm}$

Amber

C503B-AAS/AAN (15 degree)

Bin Code	Min. (mcd)	Max. (mcd)
Y0	5860	8200
Z0	8200	12000
A0	12000	16800
B0	16800	23500

C503B-ABS/ABN (23 degree)

Bin Code	Min. (mcd)	Max. (mcd)
W0	3000	4180
X0	4180	5860
Y0	5860	8200
Z0	8200	12000

C503B-ACS/ACN (30 degree)

Bin Code	Min. (mcd)	Max. (mcd)
X0	4180	5860
Y0	5860	8200
Z0	8200	12000

Amber

Bin Code	Min. (nm)	Max. (nm)
A2	584	587
A3	587	590
A4	590	593
A5	593	596

ORDER CODE TABLE*

Red (15 degree)

Color	Kit Number	Viewing Angle	Luminous Intensity (mcd)		Dominant Wavelength				Package	Standoff
			Min.	Max.	Color Bin	Min. (nm)	Color Bin	Max. (nm)		
Red	C503B-RAS-CY0B0AA1	15	5860	23500	RA	618	RA	630	Bulk	Yes
Red	C503B-RAS-CZ0A0AA1	15	8200	16800	RA	618	RA	630	Bulk	Yes
Red	C503B-RAS-CA0B0AA1	15	12000	23500	RA	618	RA	630	Bulk	Yes
Red	C503B-RAN-CY0B0AA1	15	5860	23500	RA	618	RA	630	Bulk	No
Red	C503B-RAN-CZ0A0AA1	15	8200	16800	RA	618	RA	630	Bulk	No
Red	C503B-RAN-CA0B0AA1	15	12000	23500	RA	618	RA	630	Bulk	No
Red	C503B-RAS-CY0B0AA2	15	5860	23500	RA	618	RA	630	Ammo	Yes
Red	C503B-RAS-CZ0A0AA2	15	8200	16800	RA	618	RA	630	Ammo	Yes
Red	C503B-RAS-CA0B0AA2	15	12000	23500	RA	618	RA	630	Ammo	Yes
Red	C503B-RAN-CY0B0AA2	15	5860	23500	RA	618	RA	630	Ammo	No
Red	C503B-RAN-CZ0A0AA2	15	8200	16800	RA	618	RA	630	Ammo	No
Red	C503B-RAN-CA0B0AA2	15	12000	23500	RA	618	RA	630	Ammo	No

Red (23 degree)

Color	Kit Number	Viewing Angle	Luminous Intensity (mcd)		Dominant Wavelength				Package	Standoff
			Min.	Max.	Color Bin	Min. (nm)	Color Bin	Max. (nm)		
Red	C503B-RBS-CW0Z0AA1	23	3000	12000	RA	618	RA	630	Bulk	Yes
Red	C503B-RBS-CX0Y0AA1	23	4180	8200	RA	618	RA	630	Bulk	Yes
Red	C503B-RBS-CY0Z0AA1	23	5860	12000	RA	618	RA	630	Bulk	Yes
Red	C503B-RBN-CW0Z0AA1	23	3000	12000	RA	618	RA	630	Bulk	No
Red	C503B-RBN-CX0Y0AA1	23	4180	8200	RA	618	RA	630	Bulk	No
Red	C503B-RBN-CY0Z0AA1	23	5860	12000	RA	618	RA	630	Bulk	No
Red	C503B-RBS-CW0Z0AA2	23	3000	12000	RA	618	RA	630	Ammo	Yes
Red	C503B-RBS-CX0Y0AA2	23	4180	8200	RA	618	RA	630	Ammo	Yes
Red	C503B-RBS-CY0Z0AA2	23	5860	12000	RA	618	RA	630	Ammo	Yes
Red	C503B-RBN-CW0Z0AA2	23	3000	12000	RA	618	RA	630	Ammo	No
Red	C503B-RBN-CX0Y0AA2	23	4180	8200	RA	618	RA	630	Ammo	No
Red	C503B-RBN-CY0Z0AA2	23	5860	12000	RA	618	RA	630	Ammo	No

ORDER CODE TABLE*

Red (30 degree)

Color	Kit Number	Viewing Angle	Luminous Intensity (mcd)		Dominant Wavelength				Package	Standoff
			Min.	Max.	Color Bin	Min. (nm)	Color Bin	Max. (nm)		
Red	C503B-RCS-CW0Z0AA1	30	3000	12000	RA	618	RA	630	Bulk	Yes
Red	C503B-RCS-CW0X0AA1	30	3000	5860	RA	618	RA	630	Bulk	Yes
Red	C503B-RCS-CX0Y0AA1	30	4180	8200	RA	618	RA	630	Bulk	Yes
Red	C503B-RCN-CW0Z0AA1	30	3000	12000	RA	618	RA	630	Bulk	No
Red	C503B-RCN-CW0X0AA1	30	3000	5860	RA	618	RA	630	Bulk	No
Red	C503B-RCN-CX0Y0AA1	30	4180	8200	RA	618	RA	630	Bulk	No
Red	C503B-RCS-CW0Z0AA2	30	3000	12000	RA	618	RA	630	Ammo	Yes
Red	C503B-RCS-CW0X0AA2	30	3000	5860	RA	618	RA	630	Ammo	Yes
Red	C503B-RCS-CX0Y0AA2	30	4180	8200	RA	618	RA	630	Ammo	Yes
Red	C503B-RCN-CW0Z0AA2	30	3000	12000	RA	618	RA	630	Ammo	No
Red	C503B-RCN-CW0X0AA2	30	3000	5860	RA	618	RA	630	Ammo	No
Red	C503B-RCN-CX0Y0AA2	30	4180	8200	RA	618	RA	630	Ammo	No

ORDER CODE TABLE*

Amber (15 degree)

Color	Kit Number	Viewing Angle	Luminous Intensity (mcd)		Dominant Wavelength				Package	Standoff
			Min.	Max.	Color Bin	Min. (nm)	Color Bin	Max. (nm)		
Amber	C503B-AAS-CY0B0251	15	5860	23500	A2	584	A5	596	Bulk	Yes
Amber	C503B-AAS-CZ0B0341	15	8200	23500	A3	587	A4	593	Bulk	Yes
Amber	C503B-AAS-CA0B0341	15	12000	23500	A3	587	A4	593	Bulk	Yes
Amber	C503B-AAN-CY0B0251	15	5860	23500	A2	584	A5	596	Bulk	No
Amber	C503B-AAN-CZ0B0341	15	8200	23500	A3	587	A4	593	Bulk	No
Amber	C503B-AAN-CA0B0341	15	12000	23500	A3	587	A4	593	Bulk	No
Amber	C503B-AAS-CY0B0252	15	5860	23500	A2	584	A5	596	Ammo	Yes
Amber	C503B-AAS-CZ0B0342	15	8200	23500	A3	587	A4	593	Ammo	Yes
Amber	C503B-AAS-CA0B0342	15	12000	23500	A3	587	A4	593	Ammo	Yes
Amber	C503B-AAN-CY0B0252	15	5860	23500	A2	584	A5	596	Ammo	No
Amber	C503B-AAN-CZ0B0342	15	8200	23500	A3	587	A4	593	Ammo	No
Amber	C503B-AAN-CA0B0342	15	12000	23500	A3	587	A4	593	Ammo	No

Amber (23 degree)

Color	Kit Number	Viewing Angle	Luminous Intensity (mcd)		Dominant Wavelength				Package	Standoff
			Min.	Max.	Color Bin	Min. (nm)	Color Bin	Max. (nm)		
Amber	C503B-ABS-CW0Z0251	23	3000	12000	A2	584	A5	596	Bulk	Yes
Amber	C503B-ABS-CX0Y0341	23	4180	8200	A3	587	A4	593	Bulk	Yes
Amber	C503B-ABS-CY0Z0341	23	5860	12000	A3	587	A4	593	Bulk	Yes
Amber	C503B-ABN-CW0Z0251	23	3000	12000	A2	584	A5	596	Bulk	No
Amber	C503B-ABN-CX0Y0341	23	4180	8200	A3	587	A4	593	Bulk	No
Amber	C503B-ABN-CY0Z0341	23	5860	12000	A3	587	A4	593	Bulk	No
Amber	C503B-ABS-CW0Z0252	23	3000	12000	A2	584	A5	596	Ammo	Yes
Amber	C503B-ABS-CX0Y0342	23	4180	8200	A3	587	A4	593	Ammo	Yes
Amber	C503B-ABS-CY0Z0342	23	5860	12000	A3	587	A4	593	Ammo	Yes
Amber	C503B-ABN-CW0Z0252	23	3000	12000	A2	584	A5	596	Ammo	No
Amber	C503B-ABN-CX0Y0342	23	4180	8200	A3	587	A4	593	Ammo	No
Amber	C503B-ABN-CY0Z0342	23	5860	12000	A3	587	A4	593	Ammo	No

ORDER CODE TABLE*

Amber (30 degree)

Color	Kit Number	Viewing Angle	Luminous Intensity (mcd)		Dominant Wavelength				Package	Standoff
			Min.	Max.	Color Bin	Min. (nm)	Color Bin	Max. (nm)		
Amber	C503B-ACS-CX0Z0251	30	4180	12000	A2	584	A5	596	Bulk	Yes
Amber	C503B-ACS-CX0Z0341	30	4180	12000	A3	587	A4	593	Bulk	Yes
Amber	C503B-ACS-CX0Y0251	30	4180	8200	A2	584	A5	596	Bulk	Yes
Amber	C503B-ACS-CX0Y0341	30	4180	8200	A3	587	A4	593	Bulk	Yes
Amber	C503B-ACS-CY0Z0251	30	5860	12000	A2	584	A5	596	Bulk	Yes
Amber	C503B-ACS-CY0Z0341	30	5860	12000	A3	587	A4	593	Bulk	Yes
Amber	C503B-ACN-CX0Z0251	30	4180	12000	A2	584	A5	596	Bulk	No
Amber	C503B-ACN-CX0Z0341	30	4180	12000	A3	587	A4	593	Bulk	No
Amber	C503B-ACN-CX0Y0251	30	4180	8200	A2	584	A5	596	Bulk	No
Amber	C503B-ACN-CX0Y0341	30	4180	8200	A3	587	A4	593	Bulk	No
Amber	C503B-ACN-CY0Z0251	30	5860	12000	A2	584	A5	596	Bulk	No
Amber	C503B-ACN-CY0Z0341	30	5860	12000	A3	587	A4	593	Bulk	No
Amber	C503B-ACS-CX0Z0252	30	4180	12000	A2	584	A5	596	Ammo	Yes
Amber	C503B-ACS-CX0Z0342	30	4180	12000	A3	587	A4	593	Ammo	Yes
Amber	C503B-ACS-CX0Y0252	30	4180	8200	A2	584	A5	596	Ammo	Yes
Amber	C503B-ACS-CX0Y0342	30	4180	8200	A3	587	A4	593	Ammo	Yes
Amber	C503B-ACS-CY0Z0252	30	5860	12000	A2	584	A5	596	Ammo	Yes
Amber	C503B-ACS-CY0Z0342	30	5860	12000	A3	587	A4	593	Ammo	Yes
Amber	C503B-ACN-CX0Z0252	30	4180	12000	A2	584	A5	596	Ammo	No
Amber	C503B-ACN-CX0Z0342	30	4180	12000	A3	587	A4	593	Ammo	No
Amber	C503B-ACN-CX0Y0252	30	4180	8200	A2	584	A5	596	Ammo	No
Amber	C503B-ACN-CX0Y0342	30	4180	8200	A3	587	A4	593	Ammo	No
Amber	C503B-ACN-CY0Z0252	30	5860	12000	A2	584	A5	596	Ammo	No
Amber	C503B-ACN-CY0Z0342	30	5860	12000	A3	587	A4	593	Ammo	No

Notes:

1. The above kit numbers represent order codes that include multiple intensity-bin and color-bin codes. Only one intensity-bin code and one color-bin code will be shipped on each bulk. Single intensity-bin code and single color-bin codes will not be orderable.
2. Please refer to the "Cree LED Lamp Reliability Test Standards" document for reliability test conditions.
3. Please refer to the "Cree LED Lamp Soldering & Handling" document for information about how to use this LED product safely.

GRAPHS

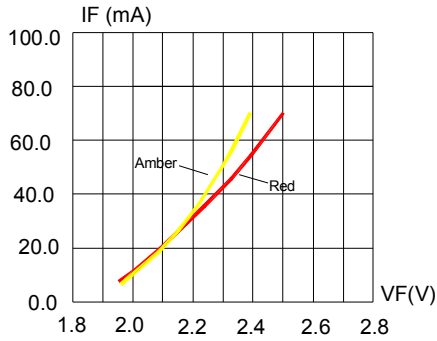

FIG.1 FORWARD CURRENT VS. FORWARD VOLTAGE.

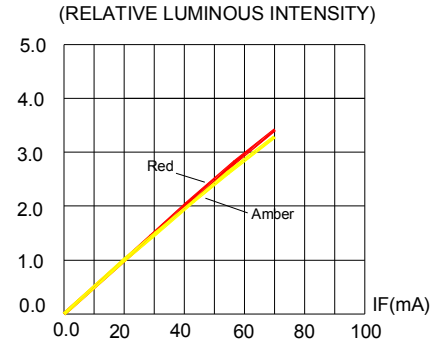

FIG.2 RELATIVE LUMINOUS INTENSITY VS. FORWARD CURRENT

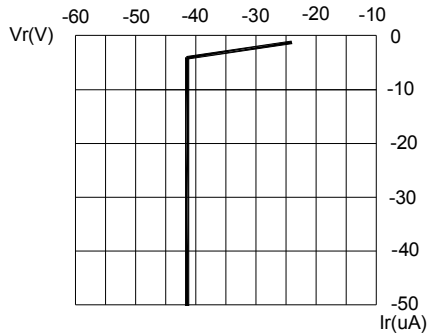

FIG.3 RED & AMBER REVERSE CURRENT VS. REVERSE VOLTAGE.

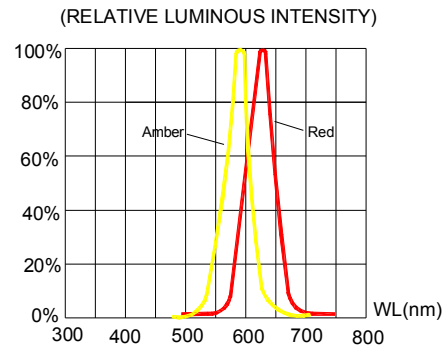

FIG.4 RELATIVE LUMINOUS INTENSITY VS. WAVELENGTH.

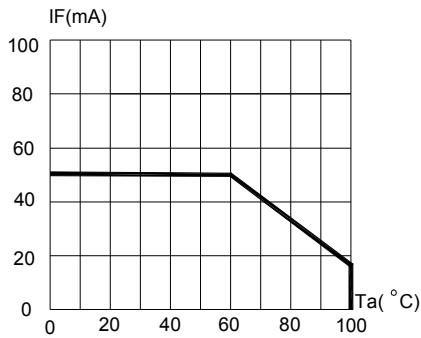

FIG.5 RED & AMBER MAXIMUM FORWARD DC CURRENT VS AMBIENT TEMPERATURE ($T_{jmax}=110^{\circ}C$)

The above data are collected from statistical figures that do not necessarily correspond to the actual parameters of each single LED. Hence, these data will be changed without further notice.

GRAPHS

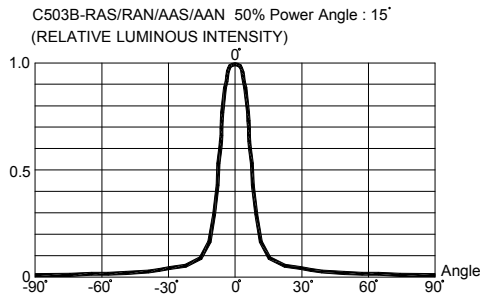

FIG.6 FAR FIELD PATTERN

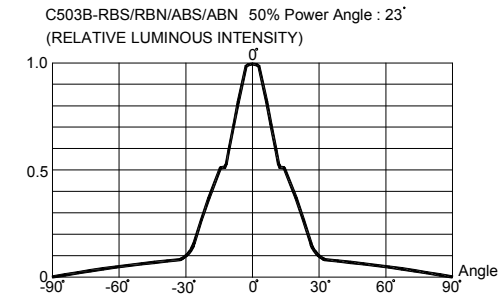

FIG.7 FAR FIELD PATTERN

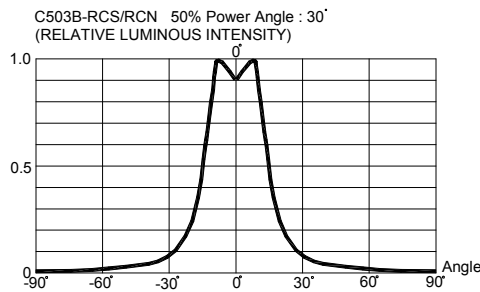

FIG.8 FAR FIELD PATTERN

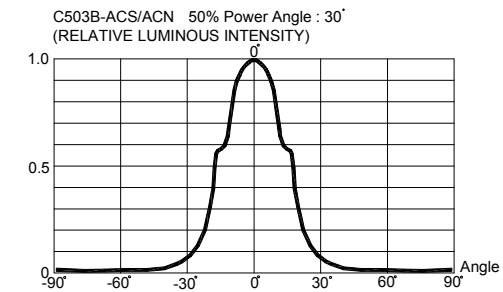

FIG.9 FAR FIELD PATTERN

The above data are collected from statistical figures that do not necessarily correspond to the actual parameters of each single LED. Hence, these data will be changed without further notice.

MECHANICAL DIMENSIONS

All dimensions are in mm. Tolerance is ± 0.25 mm unless otherwise noted.

An epoxy meniscus may extend about 1.5 mm down the leads.

Burr around bottom of epoxy may be 0.5 mm max.

C503B-RAS/AAS:

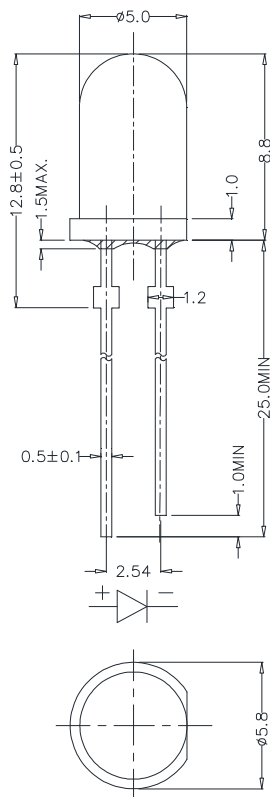

C503B-RBS/ABS:

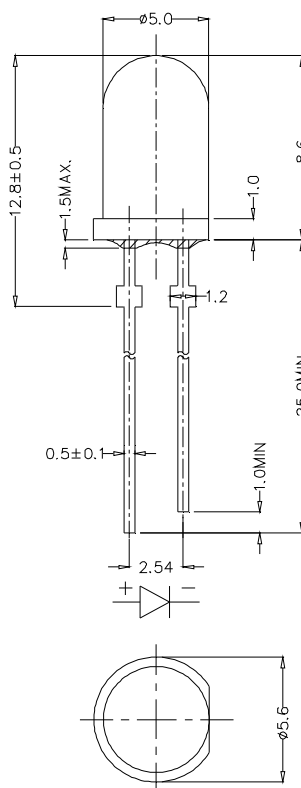

C503B-RCS:

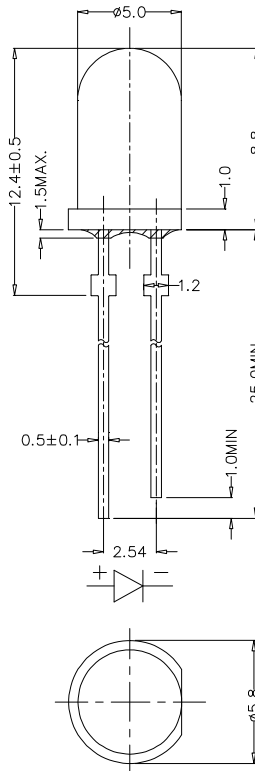

C503B-ACS:

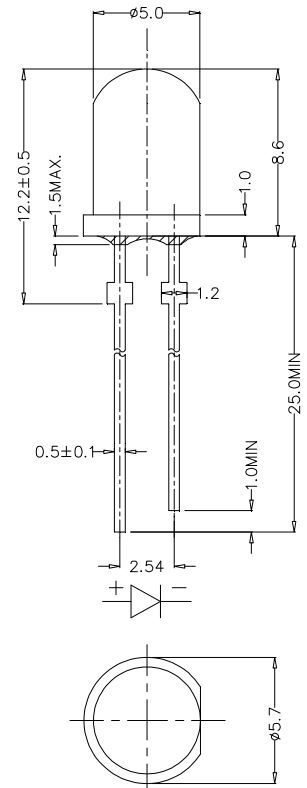

NOTES

RoHS Compliance

The levels of environmentally sensitive, persistent biologically toxic (PBT), persistent organic pollutants (POP), or otherwise restricted materials in this product are below the maximum concentration values (also referred to as the threshold limits) permitted for such substances, or are used in an exempted application, in accordance with EU Directive 2002/95/EC on the restriction of the use of certain hazardous substances in electrical and electronic equipment (RoHS), as amended through April 21, 2006.

Vision Advisory Claim

Users should be cautioned not to stare at the light of this LED product. The bright light can damage the eye.

MECHANICAL DIMENSIONS

All dimensions are in mm. Tolerance is ± 0.25 mm unless otherwise noted.

An epoxy meniscus may extend about 1.5 mm down the leads.

Burr around bottom of epoxy may be 0.5 mm max.

C503B-RAN/AAN/RCN:

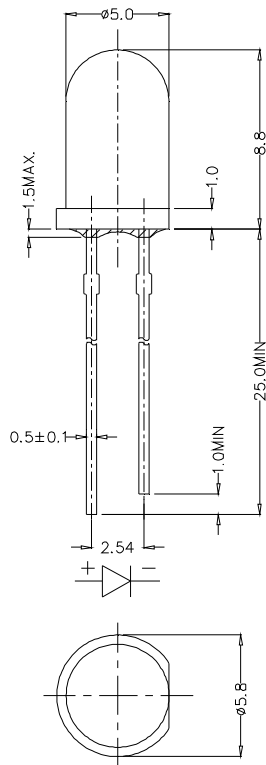

C503B-RBN/ABN:

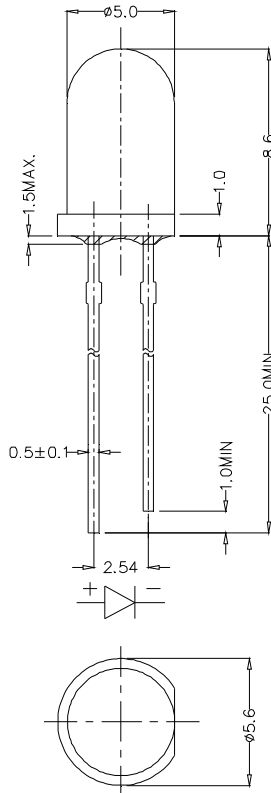

C503B-ACN:

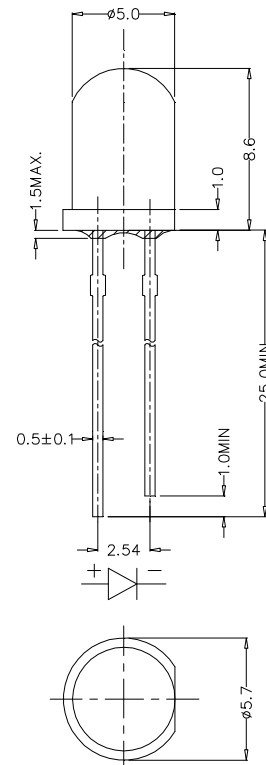

NOTES

RoHS Compliance

The levels of environmentally sensitive, persistent biologically toxic (PBT), persistent organic pollutants (POP), or otherwise restricted materials in this product are below the maximum concentration values (also referred to as the threshold limits) permitted for such substances, or are used in an exempted application, in accordance with EU Directive 2002/95/EC on the restriction of the use of certain hazardous substances in electrical and electronic equipment (RoHS), as amended through April 21, 2006.

Vision Advisory Claim

Users should be cautioned not to stare at the light of this LED product. The bright light can damage the eye.

KIT NUMBER SYSTEM

All dimensions in mm. Cree LED lamps are tested and sorted into performance bins. A bin is specified by ranges of color, forward voltage, and brightness. Sorted LEDs are packaged for shipping in various convenient options. Please refer to the "Cree LED Lamp Packaging Standard" document for more information about shipping and packaging options.

Cree LEDs are sold by order codes in combinations of bins called kits. Order codes are configured in the following manner:

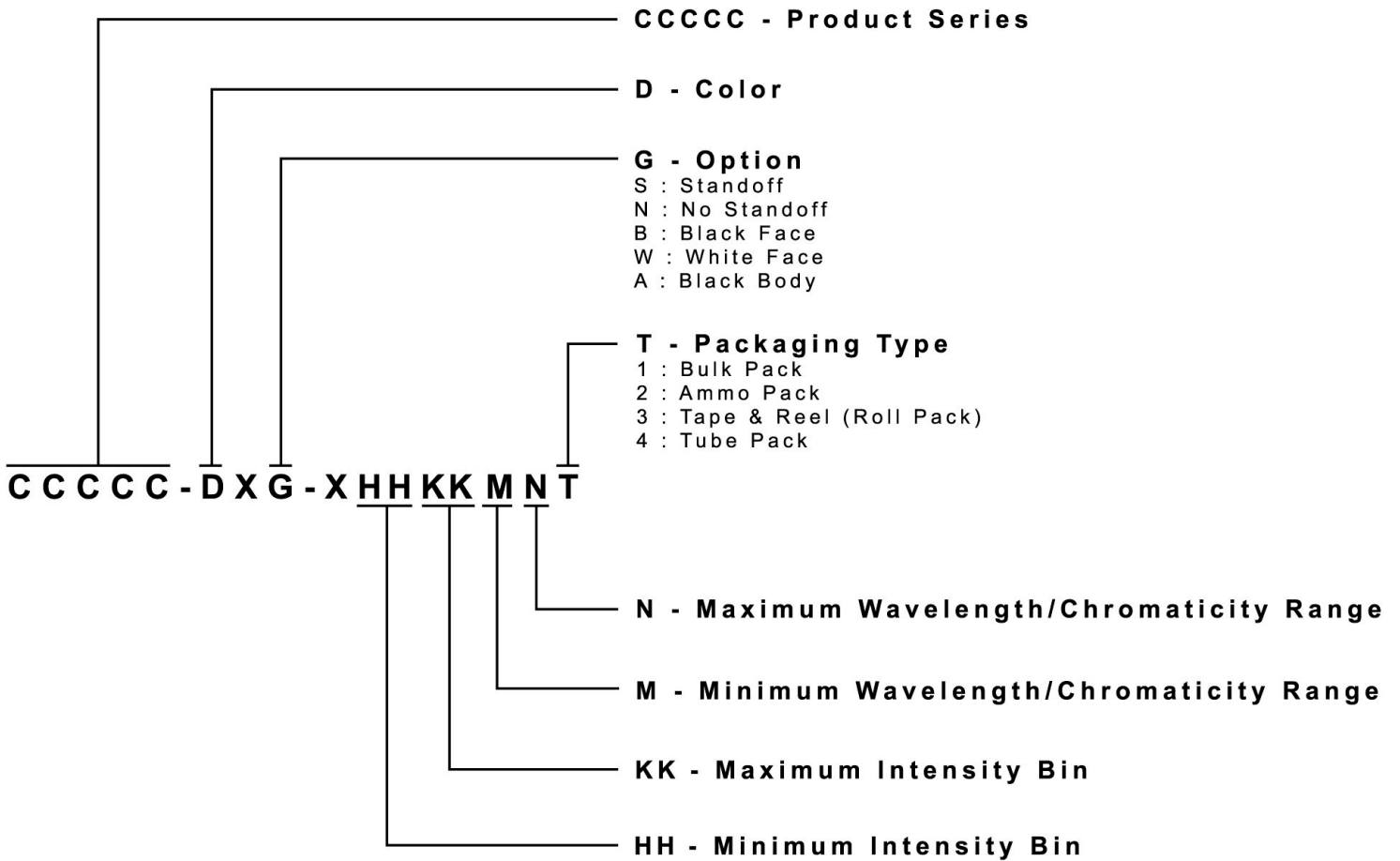

PACKAGING

Features:

- The LEDs are packed in cardboard boxes after packaging in normal or anti-electrostatic bags.
- Cardboard boxes will be used to protect the LEDs from mechanical shock during transportation.
- The boxes are not water resistant, and they must be kept away from water and moisture.
- The Bulk Pack types of packaging.
- Max 500 pcs per bulk and Max 2500 pcs per ammo.

Bulk Pack Packaging Type:

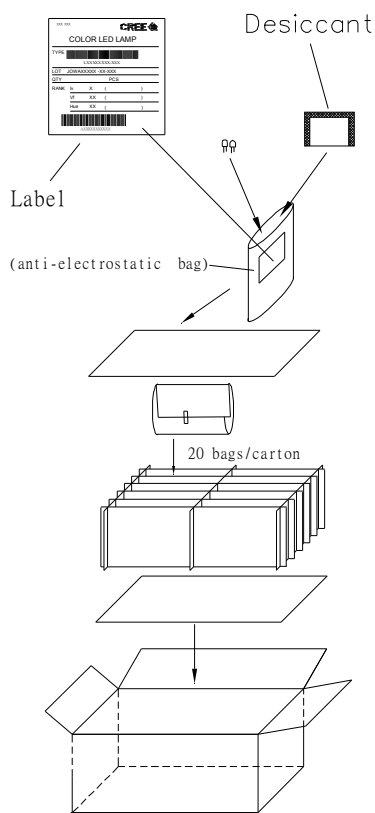

Ammo Pack Packaging Type:

