

Cree® XLamp® XHP35.2 LEDs

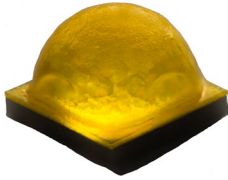

PRODUCT DESCRIPTION

The XLamp® XHP35.2 LED is the next generation of Extreme High Power LEDs available in the XP footprint. Built on Cree’s latest high-power LED technology, the XHP35.2 LED improves the voltage characteristics, efficacy and reliability of the XHP35 LED in the same 3.45 mm x 3.45 mm footprint. The new XHP35.2 LED provides an easy drop-in upgrade so that lighting manufacturers can achieve higher system LPW on existing XHP35 designs with minimal system redesign cost.

FEATURES

- Available in 5-step EasyWhite® bins at 2700 K to 5700 K CCT and 3-step EasyWhite bins at 2700 K to 3500 K CCT
- Available in ANSI white bins at 2700 K to 7000 K CCT
- Available in standard, 70-, 80-, 85- and 90-minimum CRI options
- Binned at 85 °C
- Maximum drive current: 1050 mA
- Low thermal resistance: 1.8 °C/W
- Wide viewing angle: 135°
- Unlimited floor life at ≤ 30 °C/85% RH
- Reflow solderable - JEDEC J-STD-020C
- RoHS compliant
- UL® recognized component (E349212)

TABLE OF CONTENTS

Characteristics	2
Flux Characteristics, EasyWhite® Order Codes and Bins	3
Flux Characteristics, ANSI White Order Codes and Bins	5
Relative Spectral Power Distribution	8
Relative Flux vs. Junction Temperature.....	8
Electrical Characteristics.....	9
Relative Flux vs. Current	9
Relative Chromaticity vs. Current.....	10
Relative Chromaticity vs. Temperature.....	10
Typical Spatial Distribution.....	11
Thermal Design.....	11
Performance Groups – Luminous Flux.....	12
Performance Groups – Chromaticity.....	12
Cree’s EasyWhite® Chromaticity Regions Plotted on the 1931 CIE Curve	16
Cree’s Standard Cool White Kits Plotted on ANSI Standard Chromaticity Regions..	19
Cree’s Standard Warm and Neutral White Kits Plotted on ANSI Standard Chromaticity Regions	20
Bin and Order Code Formats.....	21
Reflow Soldering Characteristics.....	22
Notes	23
Mechanical Dimensions	24
Tape and Reel.....	25
Packaging.....	26



CHARACTERISTICS

Characteristics	Unit	Minimum	Typical	Maximum
Thermal resistance, junction to solder point	°C/W		1.8	
Viewing angle (FWHM)	degrees		135	
Temperature coefficient of voltage	mV/°C		-5.6	
ESD withstand voltage (HBM per Mil-Std-883D)	V			8000
DC forward current	mA			1050
Reverse voltage	V			-5
Forward voltage (@ 350 mA, 85 °C)	V		11.2	11.9
LED junction temperature	°C			150

FLUX CHARACTERISTICS, EASYWHITE® ORDER CODES AND BINS (T_j = 85 °C)

The following table provides order codes for XLamp XHP35.2 LEDs. For a complete description of how the flux and chromaticity groups are reflected in the bin code and order code nomenclature, please see the Bin and Order Code Formats section (page 21).

Nominal CCT	CRI		Minimum Luminous Flux @350 mA		3-Step		5-Step		
	Min	Typ	Group	Flux (lm) @ 85 °C	Group	Order Code	Group	Order Code	
5700 K	70		E2	590			57E	XHP35B-00-0000-0D0BE257E	
			D4	550				XHP35B-00-0000-0D0BD457E	
	80		D4	550			57E	XHP35B-00-0000-0D0HD457E	
			D2	510				XHP35B-00-0000-0D0HD257E	
	90		C4	475			57E	XHP35B-00-0000-0D0UC457E	
			C2	440				XHP35B-00-0000-0D0UC257E	
			B4	410				XHP35B-00-0000-0D0UB457E	
	5000 K	70		E2	590			57E	XHP35B-00-0000-0D0BE250E
				D4	550				XHP35B-00-0000-0D0BD450E
80			D4	550			50E	XHP35B-00-0000-0D0HD450E	
			D2	510				XHP35B-00-0000-0D0HD250E	
90			C4	475			50E	XHP35B-00-0000-0D0UC450E	
			C2	440				XHP35B-00-0000-0D0UC250E	
			B4	410				XHP35B-00-0000-0D0UB450E	
4500 K		70		E2	590			45E	XHP35B-00-0000-0D0BE245E
				D4	550				XHP35B-00-0000-0D0BD445E
	80		D4	550			45E	XHP35B-00-0000-0D0HD445E	
			D2	510				XHP35B-00-0000-0D0HD245E	
	90		C4	475			45E	XHP35B-00-0000-0D0UC445E	
			C2	440				XHP35B-00-0000-0D0UC245E	
			B4	410				XHP35B-00-0000-0D0UB445E	
	4000 K	70		E2	590			40E	XHP35B-00-0000-0D0BE240E
				D4	550				XHP35B-00-0000-0D0BD440E
D2				510	XHP35B-00-0000-0D0BD240E				
80			D4	550			40E	XHP35B-00-0000-0D0HD440E	
			D2	510				XHP35B-00-0000-0D0HD240E	
90			C2	440			40E	XHP35B-00-0000-0D0UC240E	
			B4	410				XHP35B-00-0000-0D0UB440E	

Notes:

- Cree maintains a tolerance of ±7% on flux and power measurements, ±0.005 on chromaticity (CCx, CCy) measurements and ±2 on CRI measurements. See the Measurements section (page 23).
- Cree XLamp XHP35.2 LED order codes specify only a minimum flux bin and not a maximum. Cree may ship reels in flux bins higher than the minimum specified by the order code without advance notice. Shipments will always adhere to the chromaticity bin restrictions specified by the order code.

FLUX CHARACTERISTICS, EASYWHITE® ORDER CODES AND BINS (T_j = 85 °C) - CONTINUED

Nominal CCT	CRI		Minimum Luminous Flux @350 mA		3-Step		5-Step	
	Min	Typ	Group	Flux (lm) @ 85 °C	Group	Order Code	Group	Order Code
3500 K	70		E2	590			35E	XHP35B-00-0000-0D0BE235E
			D4	550				XHP35B-00-0000-0D0BD435E
			D2	510				XHP35B-00-0000-0D0BD235E
	80		D4	550			35E	XHP35B-00-0000-0D0HD435E
			D2	510				XHP35B-00-0000-0D0HD235E
			C4	475				XHP35B-00-0000-0D0HC435E
	90		C2	440	35G	XHP35B-00-0000-0D0UC235G	35E	XHP35B-00-0000-0D0UC235E
			B4	410		XHP35B-00-0000-0D0UB435G		XHP35B-00-0000-0D0UB435E
	3000 K	70		D4	550			30E
D2				510			XHP35B-00-0000-0D0BD230E	
80			D2	510			30E	XHP35B-00-0000-0D0HD230E
			C4	475				XHP35B-00-0000-0D0HC430E
90			C2	440	30G	XHP35B-00-0000-0D0UC230G	30E	XHP35B-00-0000-0D0UC230E
			B4	410		XHP35B-00-0000-0D0UB430G		XHP35B-00-0000-0D0UB430E
			B2	380		XHP35B-00-0000-0D0UB230G		XHP35B-00-0000-0D0UB230E
2700 K	80		C4	475			27E	XHP35B-00-0000-0D0HC427E
			C2	440				XHP35B-00-0000-0D0HC227E
	90		B4	410	27G	XHP35B-00-0000-0D0UB427G	27E	XHP35B-00-0000-0D0UB427E
			B2	380		XHP35B-00-0000-0D0UB227G		XHP35B-00-0000-0D0UB227E

Notes:

- Cree maintains a tolerance of ±7% on flux and power measurements, ±0.005 on chromaticity (CCx, CCy) measurements and ±2 on CRI measurements. See the Measurements section (page 23).
- Cree XLamp XHP35.2 LED order codes specify only a minimum flux bin and not a maximum. Cree may ship reels in flux bins higher than the minimum specified by the order code without advance notice. Shipments will always adhere to the chromaticity bin restrictions specified by the order code.

FLUX CHARACTERISTICS, ANSI WHITE ORDER CODES AND BINS (T_J = 85 °C)

The following table provides order codes for XLamp XHP35.2 LEDs. For a complete description of how the flux and chromaticity groups are reflected in the bin code and order code nomenclature, please see the Bin and Order Code Formats section (page 21).

Nominal CCT	Chromaticity Regions	CRI		Minimum Luminous Flux @ 350 mA		Order Code		
		Min	Typ	Group	Flux (lm) @ 85 °C			
7000 K	0A, 0B, 0C, 0D, 0R, 0S, 0T, 0U, 1A, 1B, 1C, 1D, 1R, 1S, 1T, 1U	0	68	E2	590	XHP35B-00-0000-0D00E20DT		
				D4	550	XHP35B-00-0000-0D00D40DT		
		70		E2	590	XHP35B-00-0000-0D0BE20DT		
				D4	550	XHP35B-00-0000-0D0BD40DT		
		80		D4	550	XHP35B-00-0000-0D0HD40DT		
				D2	510	XHP35B-00-0000-0D0HD20DT		
		90		C4	475	XHP35B-00-0000-0D0UC40DT		
				C2	440	XHP35B-00-0000-0D0UC20DT		
				B4	410	XHP35B-00-0000-0D0UB40DT		
		6500 K	1A, 1B, 1C, 1D	0	68	E2	590	XHP35B-00-0000-0D00E20E1
						D4	550	XHP35B-00-0000-0D00D40E1
				70		E2	590	XHP35B-00-0000-0D0BE20E1
D4	550					XHP35B-00-0000-0D0BD40E1		
80				D4	550	XHP35B-00-0000-0D0HD40E1		
				D2	510	XHP35B-00-0000-0D0HD20E1		
90				C4	475	XHP35B-00-0000-0D0UC40E1		
				C2	440	XHP35B-00-0000-0D0UC20E1		
				B4	410	XHP35B-00-0000-0D0UB40E1		
6000 K	1A, 1B, 1C, 1D, 1R, 1S, 1T, 1U, 2A, 2B, 2C, 2D, 2R, 2S, 2T, 2U			0	68	E2	590	XHP35B-00-0000-0D00E20DV
						D4	550	XHP35B-00-0000-0D00D40DV
				70		E2	590	XHP35B-00-0000-0D0BE20DV
		D4	550			XHP35B-00-0000-0D0BD40DV		
		80		D4	550	XHP35B-00-0000-0D0HD40DV		
				D2	510	XHP35B-00-0000-0D0HD20DV		
		90		C4	475	XHP35B-00-0000-0D0UC40DV		
				C2	440	XHP35B-00-0000-0D0UC20DV		
				B4	410	XHP35B-00-0000-0D0UB40DV		

Notes:

- Cree maintains a tolerance of ±7% on flux and power measurements, ±0.005 on chromaticity (CCx, CCy) measurements and ±2 on CRI measurements. See the Measurements section (page 23).
- Cree XLamp XHP35.2 LED order codes specify only a minimum flux bin and not a maximum. Cree may ship reels in flux bins higher than the minimum specified by the order code without advance notice. Shipments will always adhere to the chromaticity bin restrictions specified by the order code.

FLUX CHARACTERISTICS, ANSI ORDER CODES AND BINS ($T_j = 85^\circ\text{C}$) - CONTINUED

Nominal CCT	Chromaticity Regions	CRI		Minimum Luminous Flux @ 350 mA		Order Code		
		Min	Typ	Group	Flux (lm) @ 85 °C			
5700 K	2A, 2B, 2C, 2D	0	68	E2	590	XHP35B-00-0000-0D00E20E2		
				D4	550	XHP35B-00-0000-0D00D40E2		
		70		E2	590	XHP35B-00-0000-0D0BE20E2		
				D4	550	XHP35B-00-0000-0D0BD40E2		
		80		D4	550	XHP35B-00-0000-0D0HD40E2		
				D2	510	XHP35B-00-0000-0D0HD20E2		
		90		C4	475	XHP35B-00-0000-0D0UC40E2		
				C2	440	XHP35B-00-0000-0D0UC20E2		
				B4	410	XHP35B-00-0000-0D0UB40E2		
		5000 K	3A, 3B, 3C, 3D	0	68	E2	590	XHP35B-00-0000-0D00E20E3
						D4	550	XHP35B-00-0000-0D00D40E3
				70		E2	590	XHP35B-00-0000-0D0BE20E3
D4	550					XHP35B-00-0000-0D0BD40E3		
80				D4	550	XHP35B-00-0000-0D0HD40E3		
				D2	510	XHP35B-00-0000-0D0HD20E3		
90				C4	475	XHP35B-00-0000-0D0UC40E3		
				C2	440	XHP35B-00-0000-0D0UC20E3		
				B4	410	XHP35B-00-0000-0D0UB40E3		
4500 K	4A, 4B, 4C, 4D			0	68	E2	590	XHP35B-00-0000-0D00E20E4
						D4	550	XHP35B-00-0000-0D00D40E4
				70		E2	590	XHP35B-00-0000-0D0BE20E4
		D4	550			XHP35B-00-0000-0D0BD40E4		
		80		D4	550	XHP35B-00-0000-0D0HD40E4		
				D2	510	XHP35B-00-0000-0D0HD20E4		
		90		C4	475	XHP35B-00-0000-0D0UC40E4		
				C2	440	XHP35B-00-0000-0D0UC20E4		
				B4	410	XHP35B-00-0000-0D0UB40E4		

Notes:

- Cree maintains a tolerance of $\pm 7\%$ on flux and power measurements, ± 0.005 on chromaticity (CCx, CCy) measurements and ± 2 on CRI measurements. See the Measurements section (page 23).
- Cree XLamp XHP35.2 LED order codes specify only a minimum flux bin and not a maximum. Cree may ship reels in flux bins higher than the minimum specified by the order code without advance notice. Shipments will always adhere to the chromaticity bin restrictions specified by the order code.

FLUX CHARACTERISTICS, ANSI ORDER CODES AND BINS ($T_j = 85^\circ\text{C}$) - CONTINUED

Nominal CCT	Chromaticity Regions	CRI		Minimum Luminous Flux @ 350 mA		Order Code				
		Min	Typ	Group	Flux (lm) @ 85 °C					
4000 K	5A, 5B, 5C, 5D	0	68	E2	590	XHP35B-00-0000-0D00E20E5				
				D4	550	XHP35B-00-0000-0D00D40E5				
				D2	510	XHP35B-00-0000-0D00D20E5				
		70				E2	590	XHP35B-00-0000-0D0BE20E5		
						D4	550	XHP35B-00-0000-0D0BD40E5		
						D2	510	XHP35B-00-0000-0D0BD20E5		
		80				D4	550	XHP35B-00-0000-0D0HD40E5		
						D2	510	XHP35B-00-0000-0D0HD20E5		
		90				C2	440	XHP35B-00-0000-0D0UC20E5		
						B4	410	XHP35B-00-0000-0D0UB40E5		
		3500 K	6A, 6B, 6C, 6D	70				E2	590	XHP35B-00-0000-0D0BE20E6
								D4	550	XHP35B-00-0000-0D0BD40E6
D2	510							XHP35B-00-0000-0D0BD20E6		
80						D4	550	XHP35B-00-0000-0D0HD40E6		
						D2	510	XHP35B-00-0000-0D0HD20E6		
						C4	475	XHP35B-00-0000-0D0HC40E6		
90						C2	440	XHP35B-00-0000-0D0UC20E6		
						B4	410	XHP35B-00-0000-0D0UB40E6		
3000 K	7A, 7B, 7C, 7D			70				D4	550	XHP35B-00-0000-0D0BD40E7
		D2	510					XHP35B-00-0000-0D0BD20E7		
		80				D2	510	XHP35B-00-0000-0D0HD20E7		
						C4	475	XHP35B-00-0000-0D0HC40E7		
		90				C2	440	XHP35B-00-0000-0D0UC20E7		
						B4	410	XHP35B-00-0000-0D0UB40E7		
						B2	380	XHP35B-00-0000-0D0UB20E7		
2700 K	8A, 8B, 8C, 8D	80				C4	475	XHP35B-00-0000-0D0HC40E8		
						C2	440	XHP35B-00-0000-0D0HC20E8		
		90				B4	410	XHP35B-00-0000-0D0UB40E8		
						B2	380	XHP35B-00-0000-0D0UB20E8		

Notes:

- Cree maintains a tolerance of $\pm 7\%$ on flux and power measurements, ± 0.005 on chromaticity (CCx, CCy) measurements and ± 2 on CRI measurements. See the Measurements section (page 23).
- Cree XLamp XHP35.2 LED order codes specify only a minimum flux bin and not a maximum. Cree may ship reels in flux bins higher than the minimum specified by the order code without advance notice. Shipments will always adhere to the chromaticity bin restrictions specified by the order code.

RELATIVE SPECTRAL POWER DISTRIBUTION

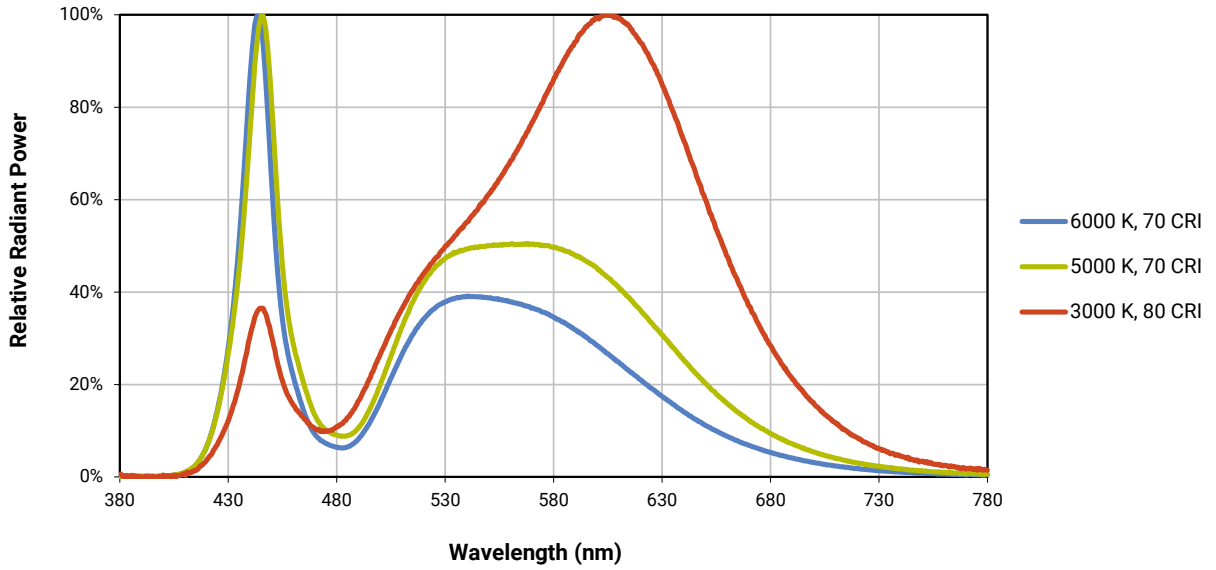

RELATIVE FLUX VS. JUNCTION TEMPERATURE ($I_F = 350$ mA)

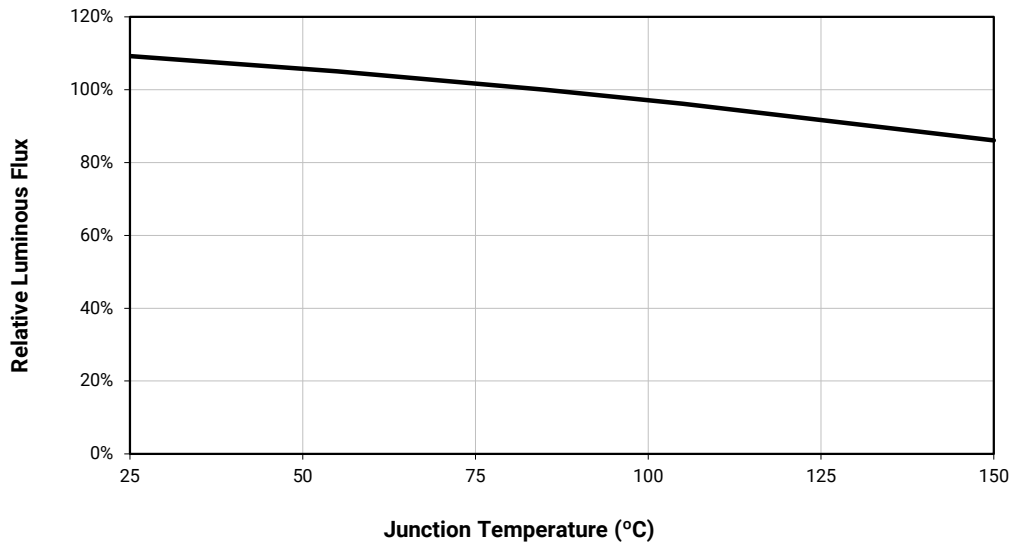

ELECTRICAL CHARACTERISTICS ($T_j = 85\text{ }^\circ\text{C}$)

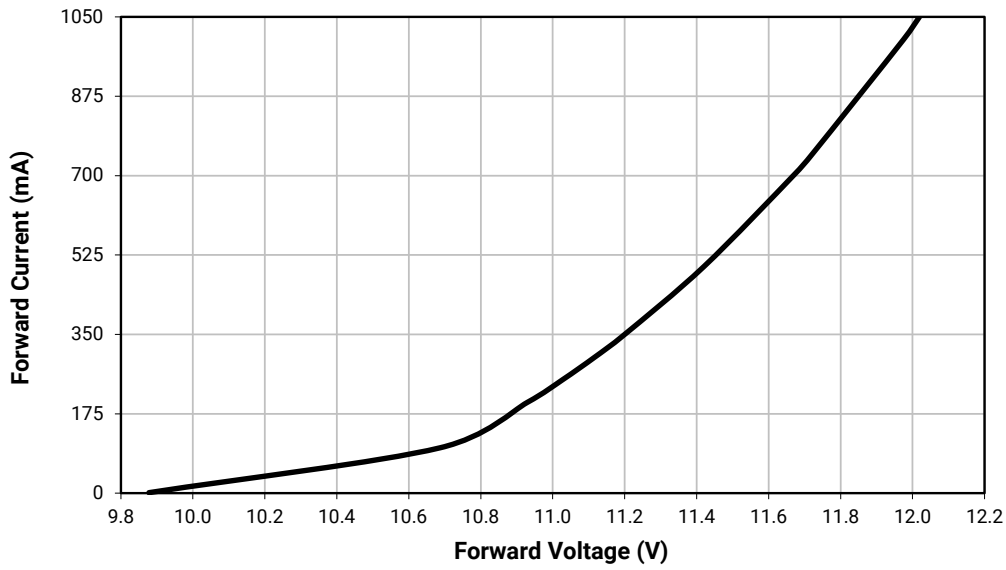

RELATIVE FLUX VS. CURRENT ($T_j = 85\text{ }^\circ\text{C}$)

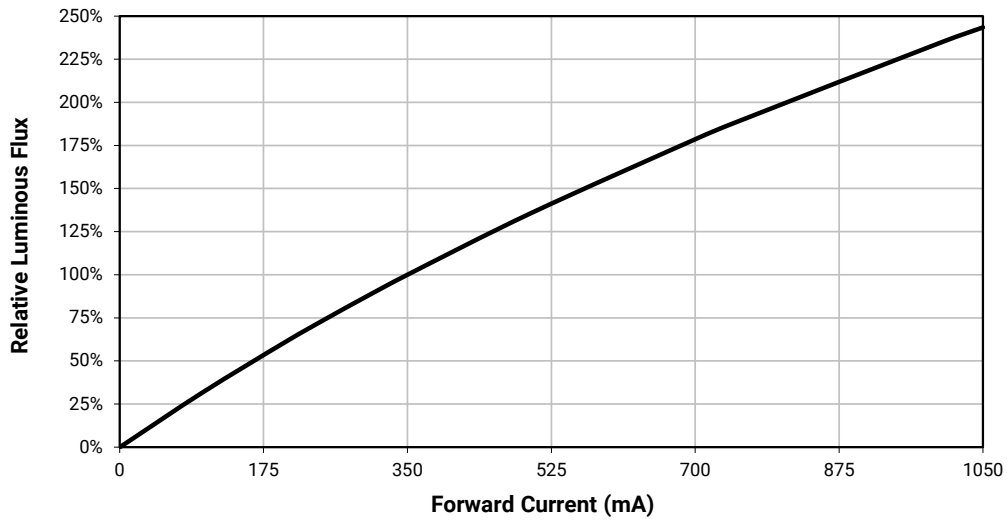

RELATIVE CHROMATICITY VS. CURRENT (WARM WHITE)

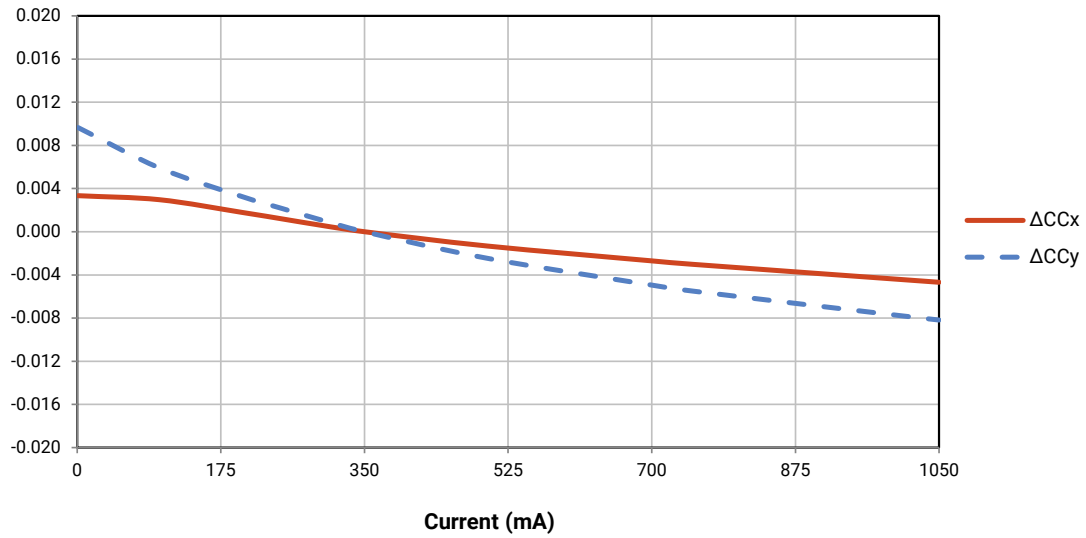

RELATIVE CHROMATICITY VS. TEMPERATURE (WARM WHITE)

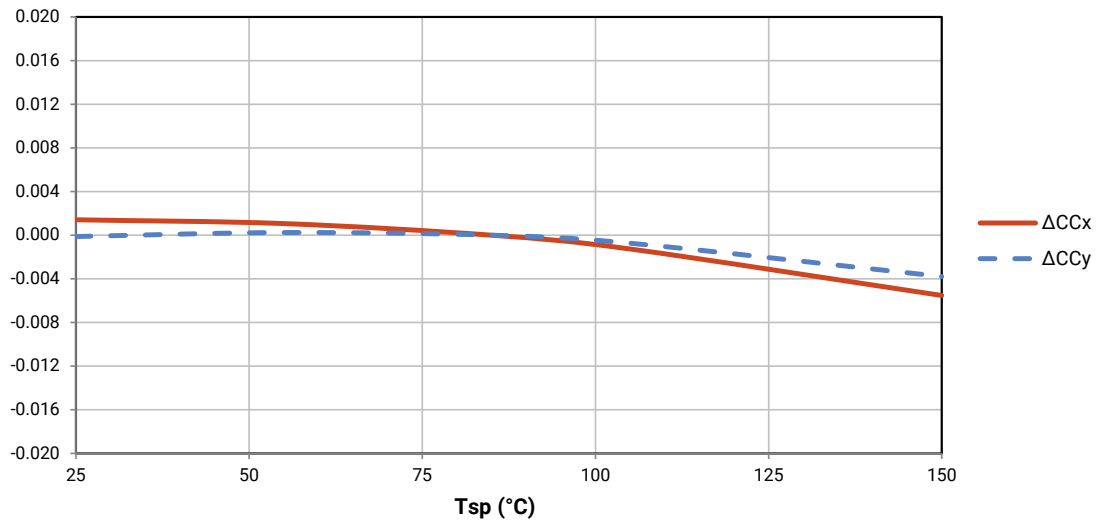

TYPICAL SPATIAL DISTRIBUTION

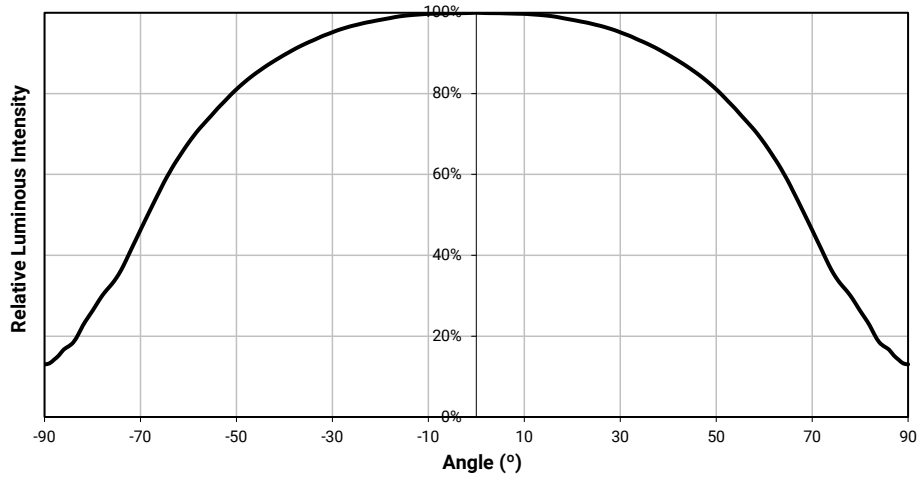

THERMAL DESIGN

The maximum forward current is determined by the thermal resistance between the LED junction and ambient. It is crucial for the end product to be designed in a manner that minimizes the thermal resistance from the solder point to ambient in order to optimize lamp life and optical characteristics.

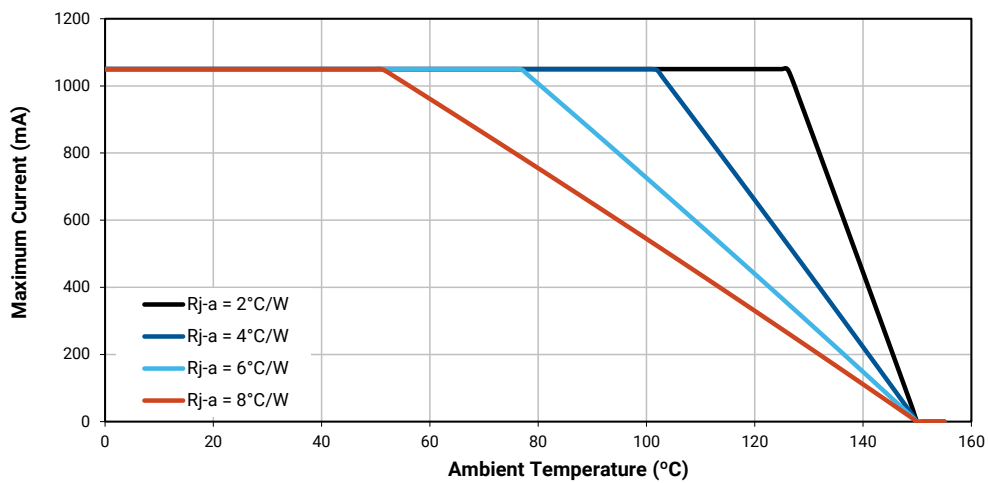

PERFORMANCE GROUPS – LUMINOUS FLUX ($T_j = 85^\circ\text{C}$)

XLamp XHP35.2 LEDs are tested for luminous flux and placed into one of the following luminous-flux groups.

Group Code	Minimum Luminous Flux	Maximum Luminous Flux
A2	330	355
A4	355	380
B2	380	410
B4	410	440
C2	440	475
C4	475	510
D2	510	550
D4	550	590
E2	590	635
E4	635	680

PERFORMANCE GROUPS – CHROMATICITY

XLamp XHP35.2 LEDs are tested for chromaticity and placed into one of the regions defined by the following bounding coordinates.

EasyWhite Color Temperatures – 3-Step Ellipse						
Bin Code	CCT	Center Point		Major Axis	Minor Axis	Rotation Angle (°)
		x	y	a	b	
35G	3500 K	0.4073	0.3917	0.00927	0.00414	54.0
30G	3000 K	0.4338	0.4030	0.00834	0.00408	53.2
27G	2700 K	0.4577	0.4099	0.00834	0.00420	48.5

EasyWhite Color Temperatures – 5-Step Ellipse						
Bin Code	CCT	Center Point		Major Axis	Minor Axis	Rotation Angle (°)
		x	y	a	b	
57E	5700 K	0.3287	0.3417	0.01230	0.00600	72.0
50E	5000 K	0.3447	0.3553	0.01400	0.00520	65.0
45E	4500 K	0.3611	0.3658	0.01420	0.00550	61.5
40E	4000 K	0.3818	0.3797	0.01565	0.00670	53.7
35E	3500 K	0.4073	0.3917	0.01545	0.00690	54.0
30E	3000 K	0.4338	0.4030	0.01390	0.00680	53.2
27E	2700 K	0.4577	0.4099	0.01350	0.00700	48.5

PERFORMANCE GROUPS – CHROMATICITY (CONTINUED)

ANSI White Bins			
CCT	Bin Code	x	y
7000 K	0A0	0.2950	0.2970
		0.2920	0.3060
		0.2984	0.3133
		0.3009	0.3042
	0B0	0.2920	0.3060
		0.2895	0.3135
		0.2962	0.3220
		0.2984	0.3133
	0C0	0.2984	0.3133
		0.2962	0.3220
		0.3028	0.3304
		0.3048	0.3207
	0D0	0.2984	0.3133
		0.3048	0.3207
		0.3068	0.3113
		0.3009	0.3042

ANSI White Bins			
CCT	Bin Code	x	y
7000 K	0R0	0.2980	0.2880
		0.2950	0.2970
		0.3009	0.3042
		0.3037	0.2937
	0S0	0.2895	0.3135
		0.2870	0.3210
		0.2937	0.3312
		0.2962	0.3220
	0T0	0.2962	0.3220
		0.2937	0.3312
		0.3005	0.3415
		0.3028	0.3304
	0U0	0.3037	0.2937
		0.3009	0.3042
		0.3068	0.3113
		0.3093	0.2993

ANSI White Bins			
CCT	Bin Code	x	y
6500 K	1A0	0.3048	0.3207
		0.3130	0.3290
		0.3144	0.3186
		0.3068	0.3113
	1B0	0.3028	0.3304
		0.3115	0.3391
		0.3130	0.3290
		0.3048	0.3207
	1C0	0.3115	0.3391
		0.3205	0.3481
		0.3213	0.3373
		0.3130	0.3290
	1D0	0.3130	0.3290
		0.3213	0.3373
		0.3221	0.3261
		0.3144	0.3186

ANSI White Bins			
CCT	Bin Code	x	y
6500 K	1R0	0.3068	0.3113
		0.3144	0.3186
		0.3161	0.3059
		0.3093	0.2993
	1S0	0.3005	0.3415
		0.3099	0.3509
		0.3115	0.3391
		0.3028	0.3304
	1T0	0.3099	0.3509
		0.3196	0.3602
		0.3205	0.3481
		0.3115	0.3391
	1U0	0.3144	0.3186
		0.3221	0.3261
		0.3231	0.3120
		0.3161	0.3059

PERFORMANCE GROUPS – CHROMATICITY (CONTINUED)

ANSI White Bins			
CCT	Bin Code	x	y
5700 K	2A0	0.3215	0.3350
		0.3290	0.3417
		0.3290	0.3300
		0.3222	0.3243
	2B0	0.3207	0.3462
		0.3290	0.3538
		0.3290	0.3417
		0.3215	0.3350
	2C0	0.3290	0.3538
		0.3376	0.3616
		0.3371	0.3490
		0.3290	0.3417
	2D0	0.3290	0.3417
		0.3371	0.3490
		0.3366	0.3369
		0.3290	0.3300

ANSI White Bins			
CCT	Bin Code	x	y
5700 K	2R0	0.3222	0.3243
		0.3290	0.3300
		0.3290	0.3180
		0.3231	0.3120
	2S0	0.3196	0.3602
		0.3290	0.3690
		0.3290	0.3538
		0.3207	0.3462
	2T0	0.3290	0.3690
		0.3381	0.3762
		0.3376	0.3616
		0.3290	0.3538
	2U0	0.3290	0.3300
		0.3366	0.3369
		0.3361	0.3245
		0.3290	0.3180

ANSI White Bins			
CCT	Bin Code	x	y
5000 K	3A0	0.3371	0.3490
		0.3451	0.3554
		0.3440	0.3427
		0.3366	0.3369
	3B0	0.3376	0.3616
		0.3463	0.3687
		0.3451	0.3554
		0.3371	0.3490
	3C0	0.3463	0.3687
		0.3551	0.3760
		0.3533	0.3620
		0.3451	0.3554
	3D0	0.3451	0.3554
		0.3533	0.3620
		0.3515	0.3487
		0.3440	0.3427

ANSI White Bins			
CCT	Bin Code	x	y
4500 K	4A0	0.3530	0.3597
		0.3615	0.3659
		0.3512	0.3465
		0.3515	0.3487
	4B0	0.3548	0.3736
		0.3641	0.3804
		0.3530	0.3597
		0.3533	0.3620
	4C0	0.3641	0.3804
		0.3736	0.3874
		0.3702	0.3722
		0.3615	0.3659
	4D0	0.3615	0.3659
		0.3702	0.3722
		0.3670	0.3578
		0.3590	0.3521

PERFORMANCE GROUPS – CHROMATICITY (CONTINUED)

ANSI White Bins			
CCT	Bin Code	x	y
4000 K	5A0	0.3670	0.3578
		0.3702	0.3722
		0.3825	0.3798
		0.3783	.3646
	5B0	0.3702	0.3722
		0.3736	0.3874
		0.3869	0.3958
		0.3825	0.3798
	5C0	0.3825	0.3798
		0.3869	0.3958
		.04006	0.4044
		0.3950	0.3875
	5D0	0.3783	0.3646
		0.3825	0.3798
		0.3950	0.3875
		0.3898	0.3716

ANSI White Bins			
CCT	Bin Code	x	y
3500 K	6A0	0.3889	0.3690
		0.3941	0.3848
		0.4080	0.3916
		0.4017	0.3751
	6B0	0.3941	0.3848
		0.3996	0.4015
		.04146	0.4089
		.04080	0.3916
	6C0	0.4080	0.3916
		0.4146	0.4089
		0.4299	0.4165
		0.4221	0.3984
	6D0	0.4017	0.3751
		0.4080	0.3916
		0.4221	0.3984
		0.4147	0.3814

ANSI White Bins			
CCT	Bin Code	x	y
3000 K	7A0	0.4147	0.3814
		0.4221	0.3984
		0.4342	0.4028
		0.4259	0.3853
	7B0	0.4221	0.3984
		0.4299	0.4165
		0.4430	0.4212
		0.4342	.04028
	7C0	0.4342	0.4028
		0.4430	0.4212
		0.4562	0.4260
		0.4465	0.4071
	7D0	0.4259	0.3853
		0.4342	0.4028
		0.4465	0.4071
		0.4373	0.3893

ANSI White Bins			
CCT	Bin Code	x	y
2700 K	8A0	0.4373	0.3893
		0.4465	0.4071
		0.4582	0.4099
		0.4483	0.3919
	8B0	0.4465	.04071
		0.4562	0.4260
		0.4687	0.4289
		.04582	0.4099
	8C0	0.4582	0.4099
		0.4687	0.4289
		0.4813	0.4319
		0.4700	0.4126
	8D0	0.4483	0.3919
		0.4582	0.4099
		0.4700	0.4126
		0.4593	0.3944

CREE'S EASYWHITE® CHROMATICITY REGIONS PLOTTED ON THE 1931 CIE CURVE

ANSI Cool White

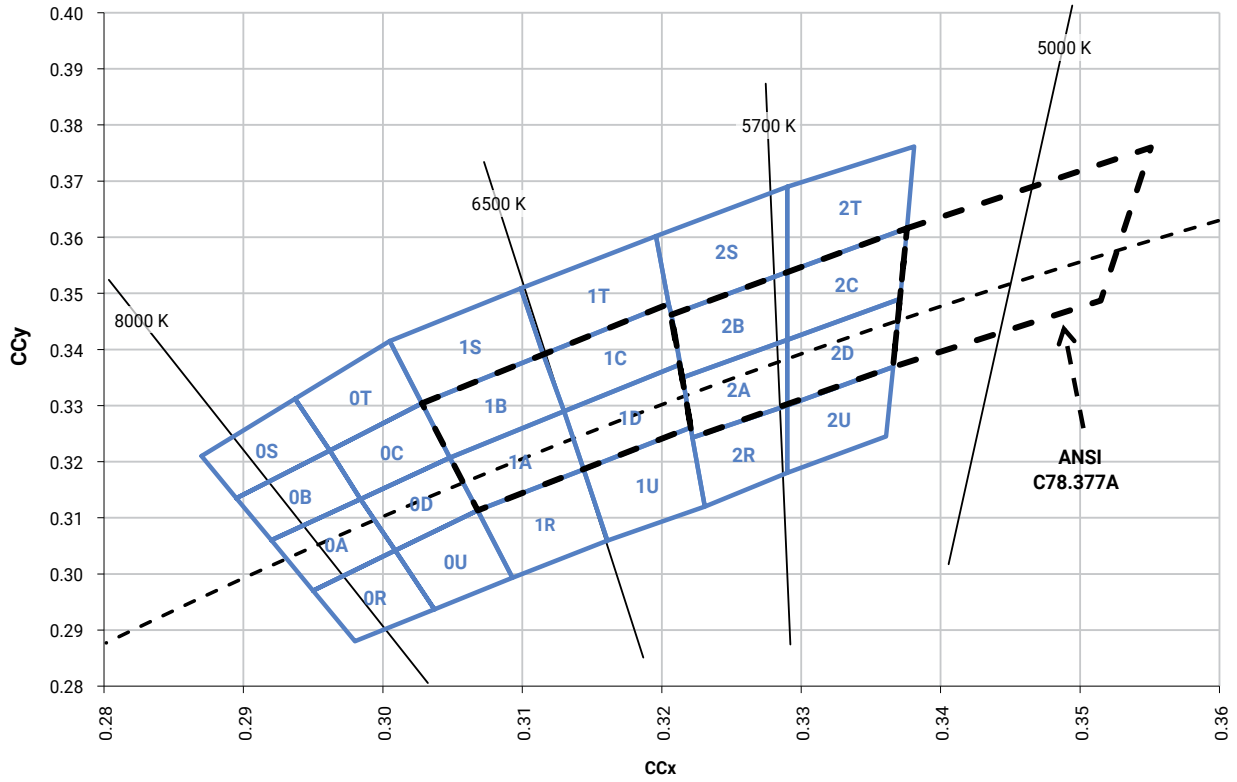

CREE'S EASYWHITE® CHROMATICITY REGIONS PLOTTED ON THE 1931 CIE CURVE - CONTINUED

ANSI Neutral White and ANSI Warm White

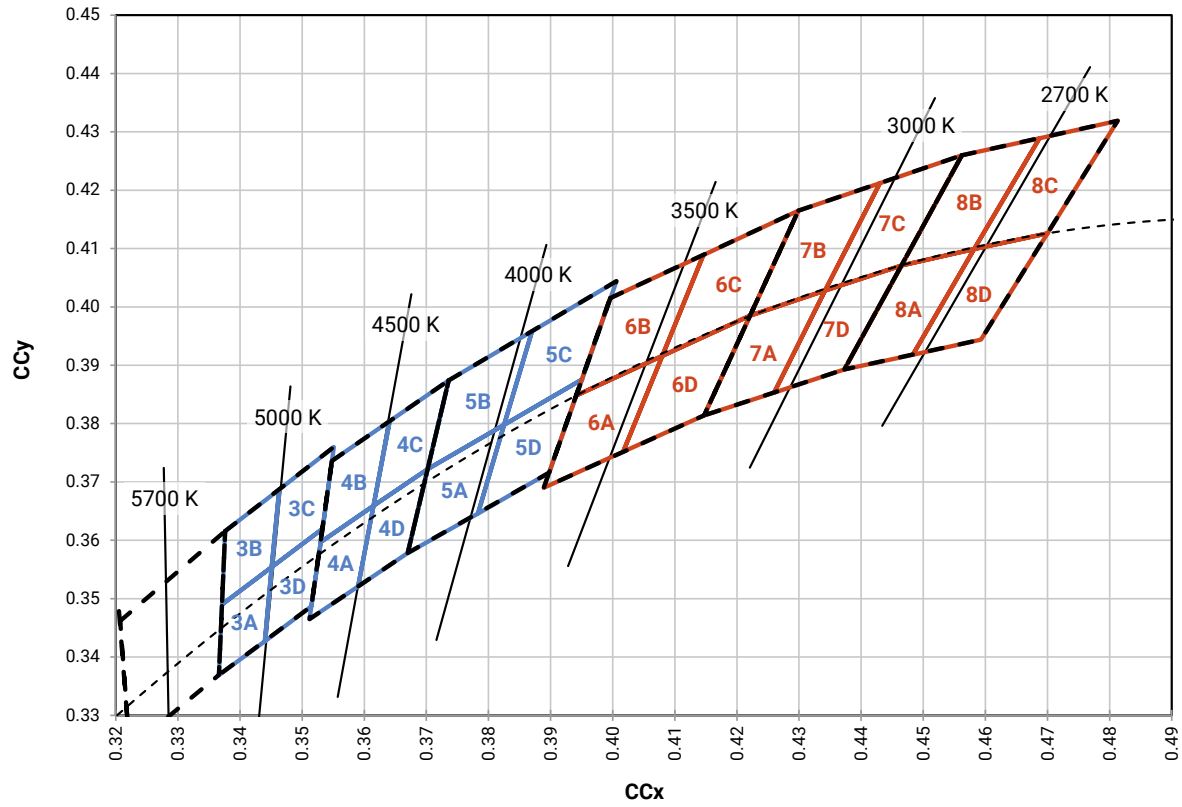

CREE'S EASYWHITE® CHROMATICITY REGIONS PLOTTED ON THE 1931 CIE CURVE - CONTINUED

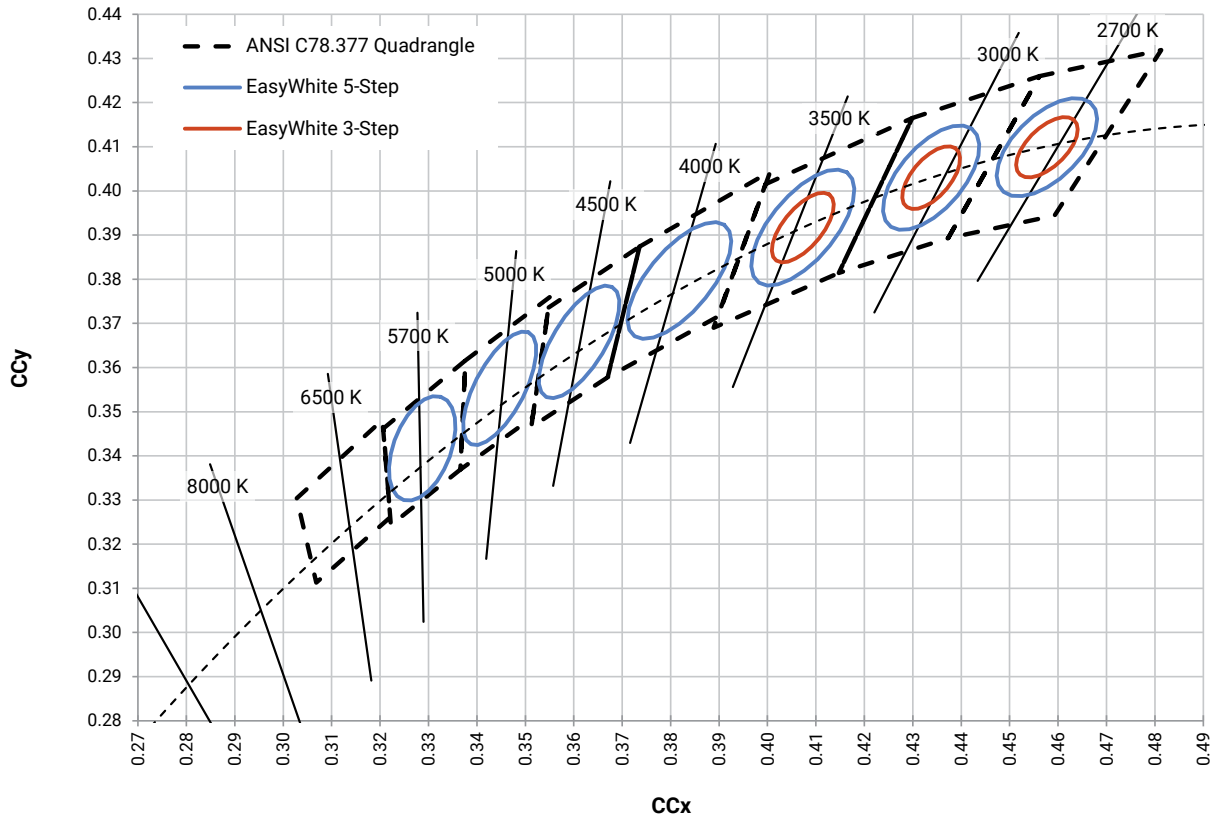

CREE'S STANDARD COOL WHITE KITS PLOTTED ON ANSI STANDARD CHROMATICITY REGIONS

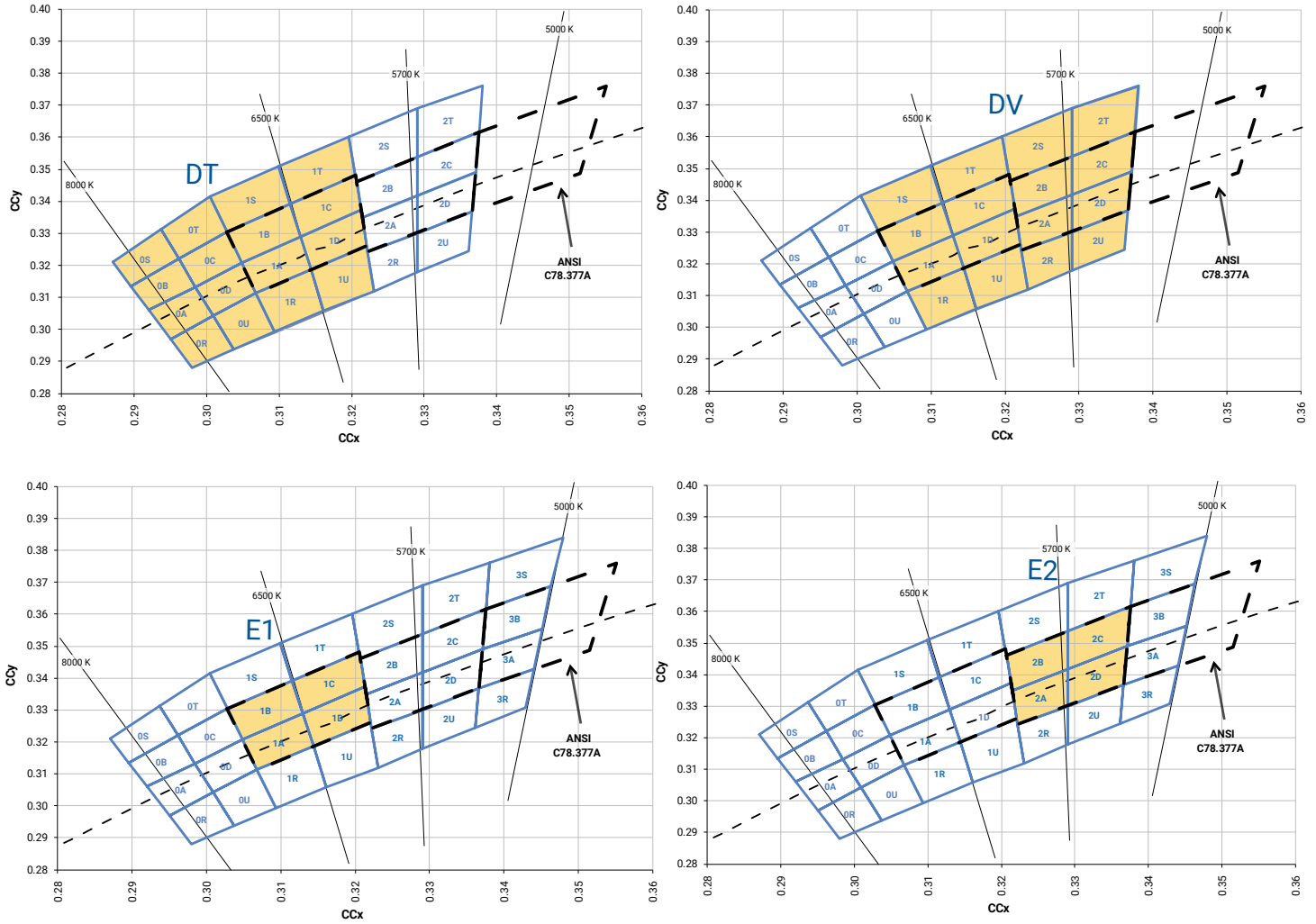

CREE'S STANDARD WARM AND NEUTRAL WHITE KITS PLOTTED ON ANSI STANDARD CHROMATICITY REGIONS

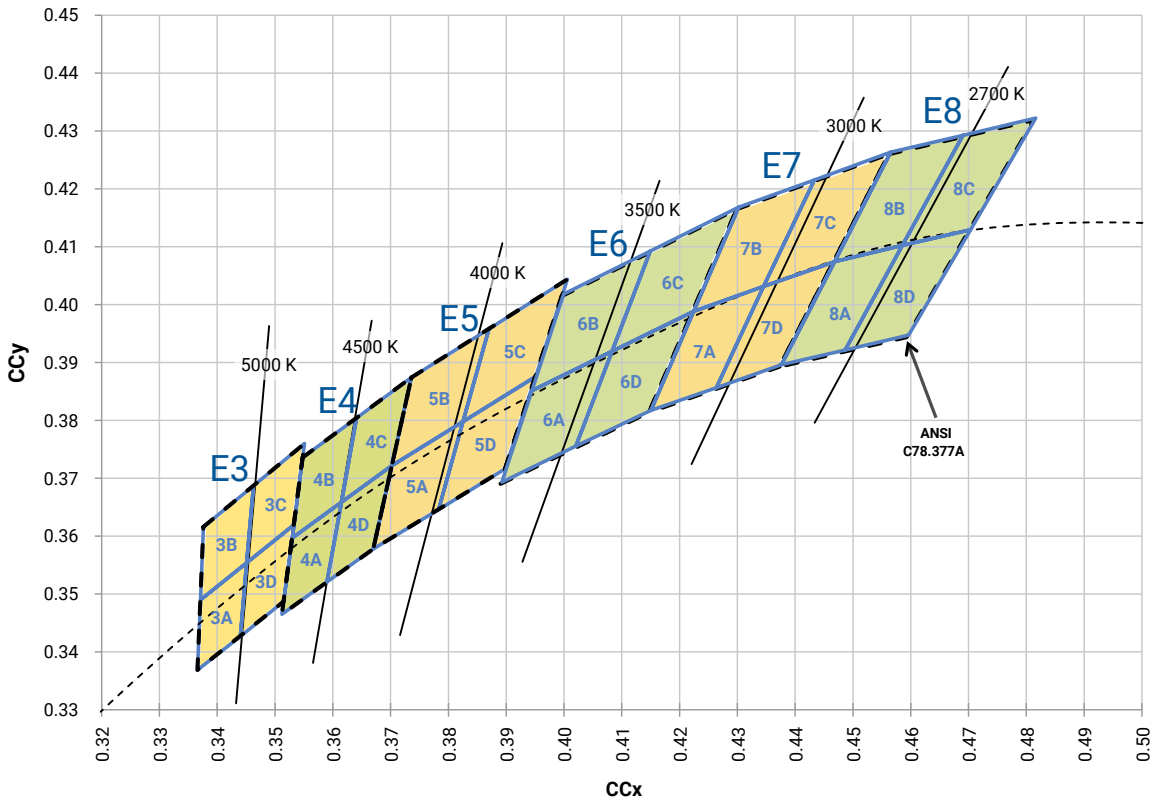

BIN AND ORDER CODE FORMATS

Bin codes and order codes for XHP35.2 LEDs are configured in the following manner:

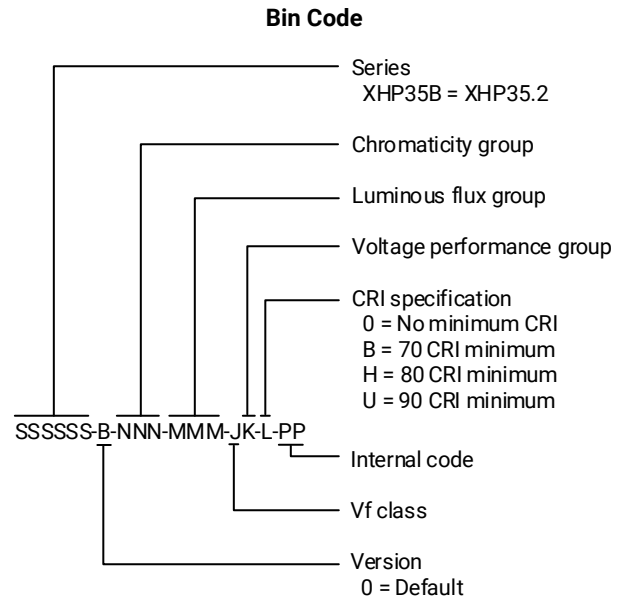
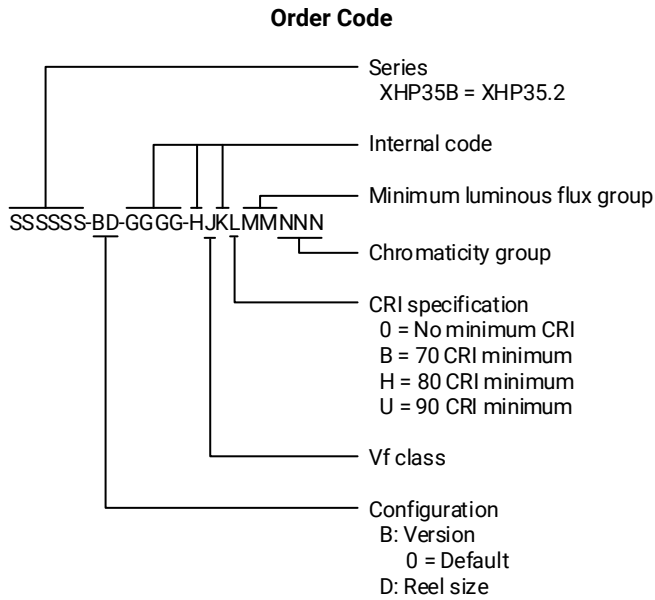

REFLOW SOLDERING CHARACTERISTICS

In testing, Cree has found XLamp XHP35.2 LEDs to be compatible with JEDEC J-STD-020C, using the parameters listed below. As a general guideline, Cree recommends that users follow the recommended soldering profile provided by the manufacturer of the solder paste used, and therefore it is the lamp or luminaire manufacturer’s responsibility to determine applicable soldering requirements.

Note that this general guideline may not apply to all PCB designs and configurations of reflow soldering equipment.

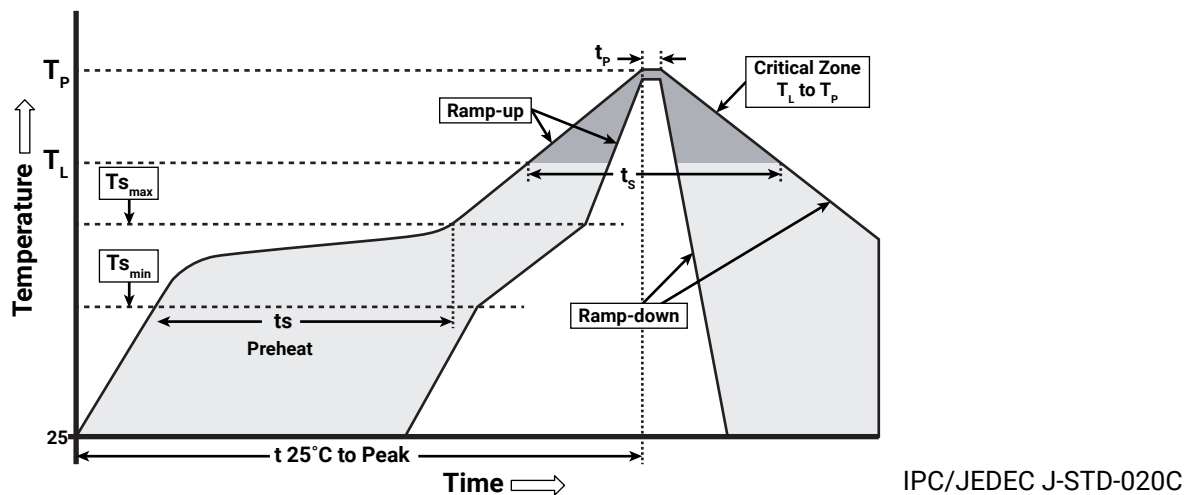

Profile Feature	Lead-Free Solder
Average Ramp-Up Rate ($T_{s_{max}}$ to T_p)	1.2 °C/second
Preheat: Temperature Min ($T_{s_{min}}$)	120 °C
Preheat: Temperature Max ($T_{s_{max}}$)	170 °C
Preheat: Time ($t_{s_{min}}$ to $t_{s_{max}}$)	65-150 seconds
Time Maintained Above: Temperature (T_L)	217 °C
Time Maintained Above: Time (t_L)	45-90 seconds
Peak/Classification Temperature (T_p)	235 - 245 °C
Time Within 5 °C of Actual Peak Temperature (t_p)	20-40 seconds
Ramp-Down Rate	1 - 6 °C/second
Time 25 °C to Peak Temperature	4 minutes max.

Note: All temperatures refer to the topside of the package, measured on the package body surface.

NOTES

Measurements

The luminous flux, radiant power, chromaticity, forward voltage and CRI measurements in this document are binning specifications only and solely represent product measurements as of the date of shipment. These measurements will change over time based on a number of factors that are not within Cree's control and are not intended or provided as operational specifications for the products. Calculated values are provided for informational purposes only and are not intended or provided as specifications.

Pre-Release Qualification Testing

Please read the [LED Reliability Overview](#) for details of the qualification process Cree applies to ensure long-term reliability for XLamp LEDs and details of Cree's pre-release qualification testing for XLamp LEDs.

Lumen Maintenance

Cree now uses standardized IES LM-80-08 and TM-21-11 methods for collecting long-term data and extrapolating LED lumen maintenance. For information on the specific LM-80 data sets available for this LED, refer to the public [LM-80 results document](#).

Please read the [Long-Term Lumen Maintenance application note](#) for more details on Cree's lumen maintenance testing and forecasting. Please read the [Thermal Management application note](#) for details on how thermal design, ambient temperature, and drive current affect the LED junction temperature.

Moisture Sensitivity

Cree recommends keeping XLamp LEDs in the provided, resealable moisture-barrier packaging (MBP) until immediately prior to soldering. Unopened MBPs that contain XLamp LEDs do not need special storage for moisture sensitivity.

Once the MBP is opened, XLamp XHP35.2 LEDs may be stored as MSL 1 per JEDEC J-STD-033, meaning they have unlimited floor life in conditions of ≤ 30 °C/85% relative humidity (RH). Regardless of the storage condition, Cree recommends sealing any unsoldered LEDs in the original MBP.

RoHS Compliance

The levels of RoHS restricted materials in this product are below the maximum concentration values (also referred to as the threshold limits) permitted for such substances, or are used in an exempted application, in accordance with EU Directive 2011/65/EC (RoHS2), as implemented January 2, 2013. RoHS Declarations for this product can be obtained from your Cree representative or from the [Product Ecology](#) section of the Cree website.

UL® Recognized Component

This product meets the requirements to be considered a UL Recognized Component with Level 4 enclosure consideration. The LED package or a portion thereof has been investigated as a fire and electrical enclosure per ANSI/UL 8750.

Vision Advisory

WARNING: Do not look at an exposed lamp in operation. Eye injury can result. For more information about LEDs and eye safety, please refer to the [LED Eye Safety application note](#).

MECHANICAL DIMENSIONS

Thermal vias, if present, are not shown on these drawings.

All dimensions are $\pm .13$ mm unless otherwise indicated.

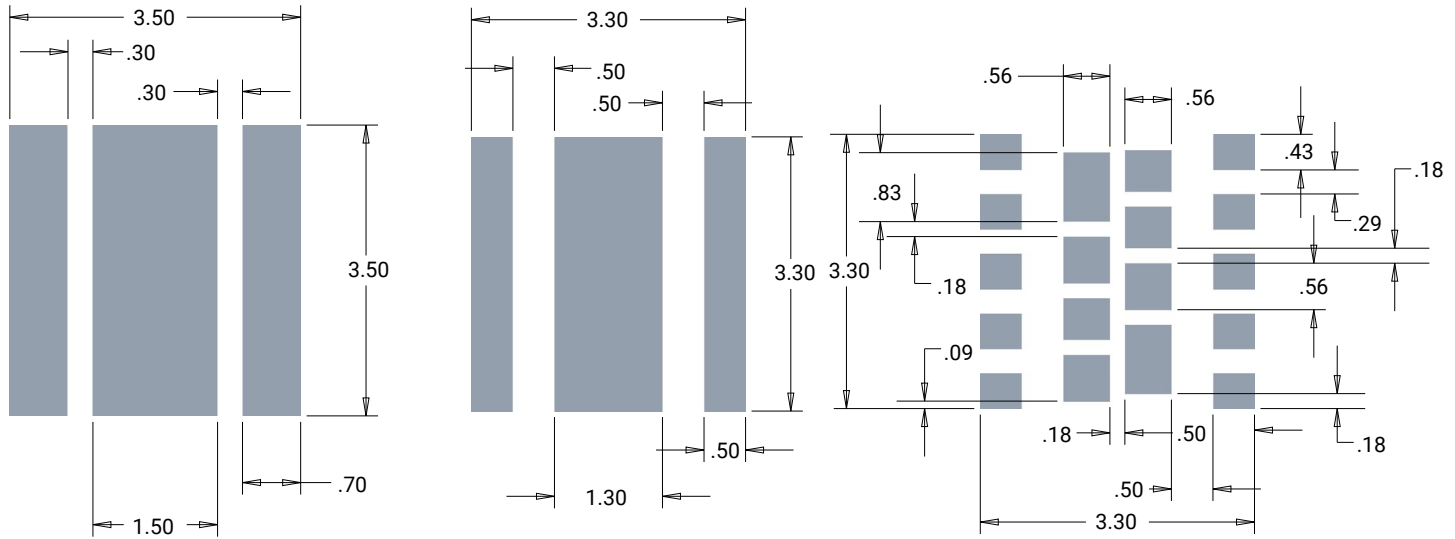
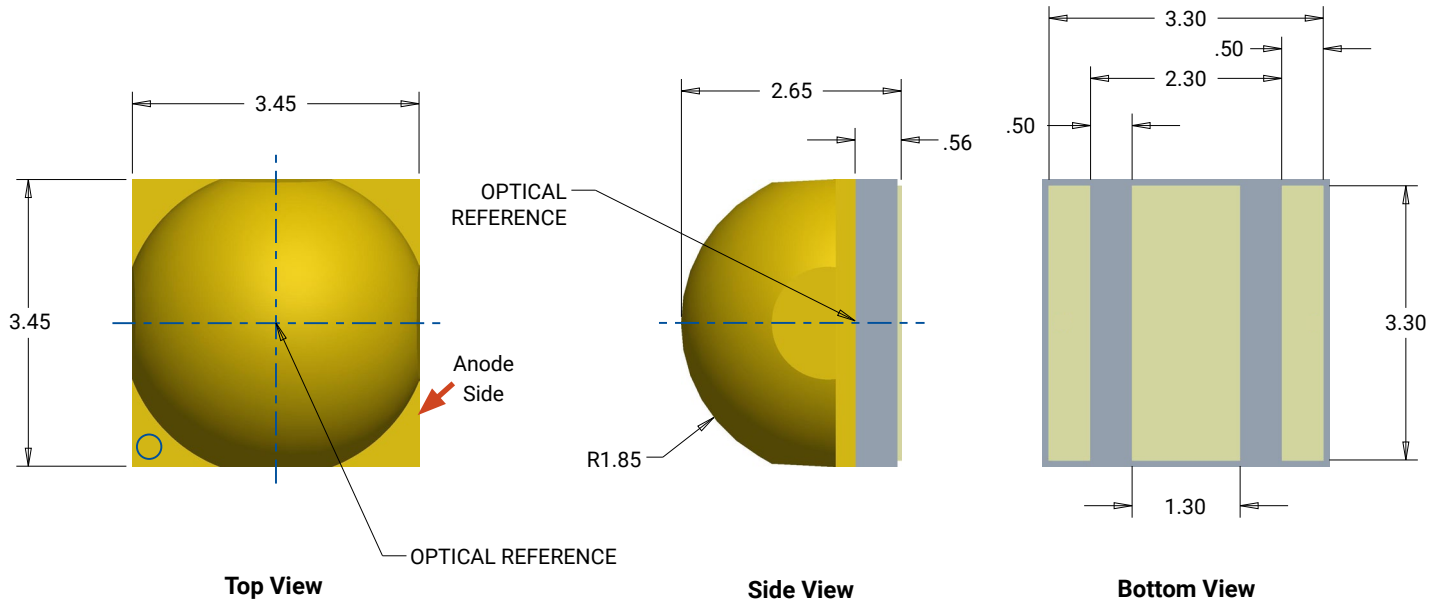

Recommended Copper Layout

**Recommended Solder Pad
(Solder Resist Pattern)**

Recommended Stencil Openings*

Notes:

- Cree recommends using thermal pad kickouts to maximize component thermal performance.
- Cree recommends using white solder mask material to minimize system optical loss.
- * This stencil has been tested and optimized for the avoidance of voiding when using ALPHA® LUMET® P30 Maxrel solder paste. For other solder pastes, a “window pane” design for the thermal pad stencil may result in a lower voiding percentage. Contact your local Cree Field Applications Engineer for consultation regarding your specific application.

TAPE AND REEL

All Cree carrier tapes conform to EIA-481D, Automated Component Handling Systems Standard.

Except as noted, all dimensions in mm [inches]

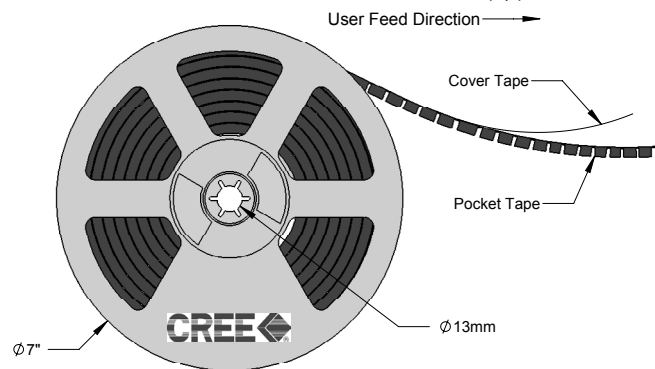
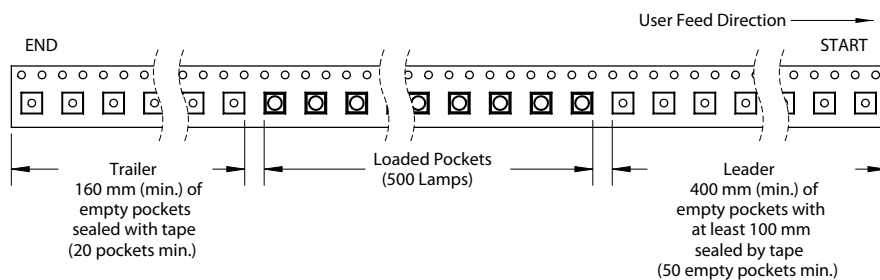
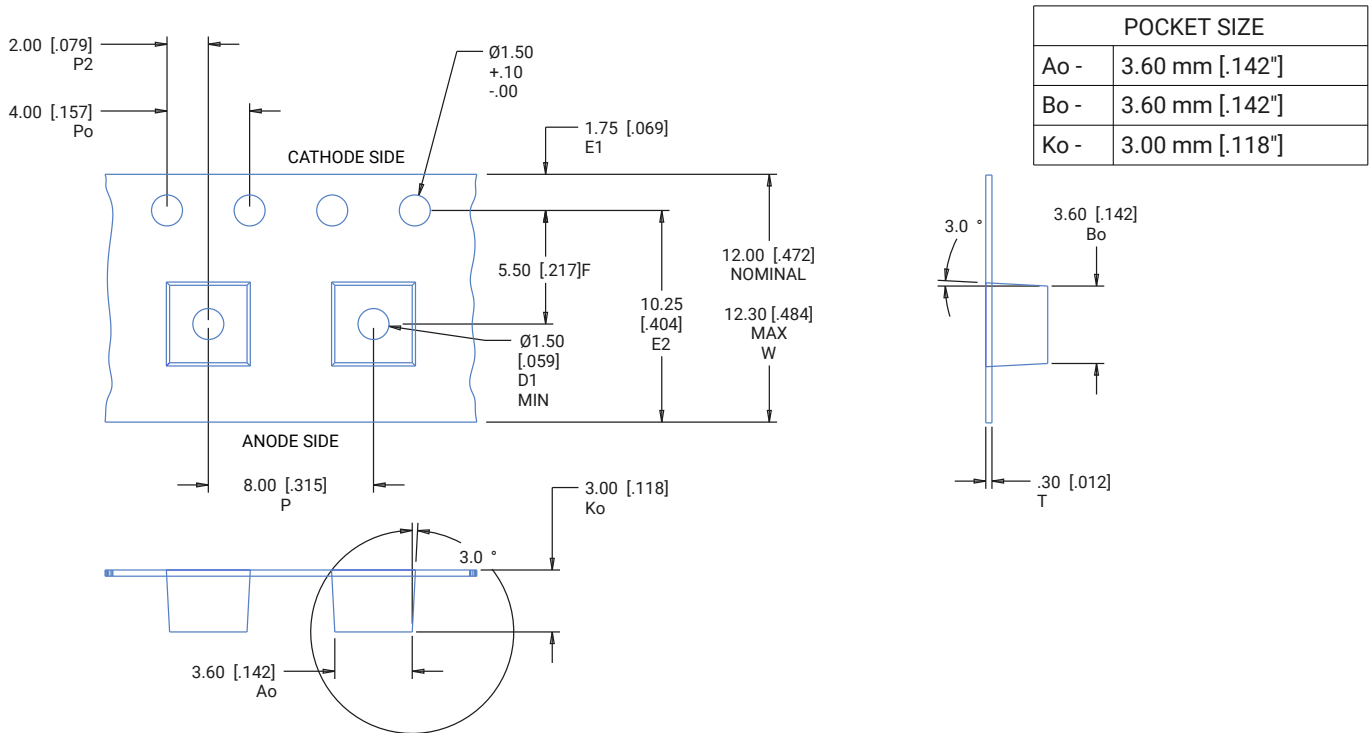

PACKAGING

Unpackaged Reel

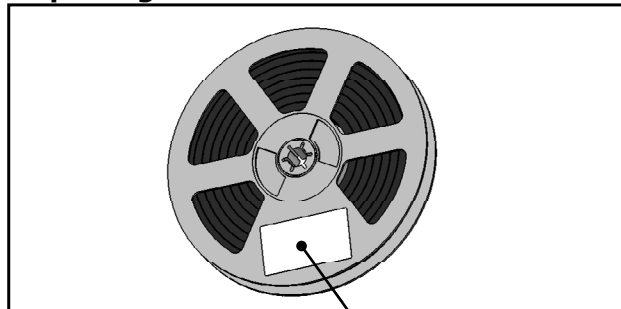

Label with Cree Bin Code,
Quantity, Reel ID

Packaged Reel

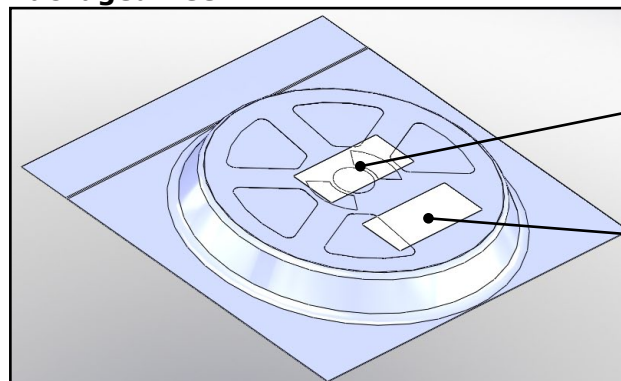

Label with Cree Order Code,
Quantity, Reel ID, PO #

Label with Cree Bin Code,
Quantity, Reel ID

Boxed Reel

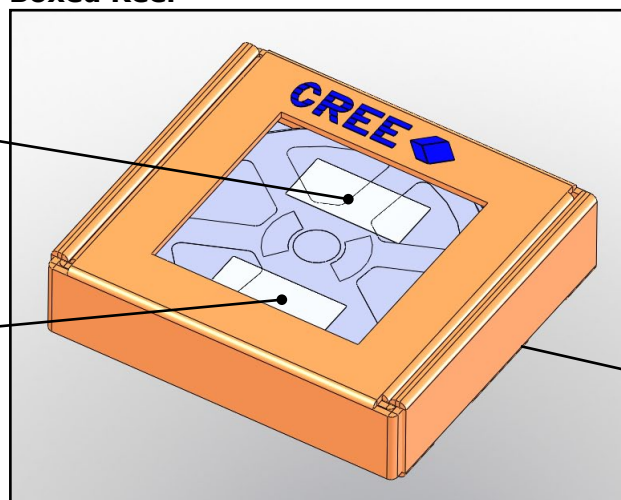

Label with Cree Order Code,
Quantity, Reel ID, PO #

Label with Cree Bin Code,
Quantity, Reel ID

Patent Label
(on bottom of box)