









Ficha técnica

Rueda BH-PPI 2-2470

Codigo				Tipo cojinete Eje					
2-2470	80	70	22	—	-	-	10	108	77



Características

Fabricada con chapa de acero hasta 2 m/m de espesor.
Soporte con doble rodamiento a bolas.
Acabado cincado brillante.
Fabricadas según normas europeas EN 12528/12530.

Datos técnicos

Diámetro: 80 mm
Carga: 70 kg
Tipo de cojinete: Cojinete Liso
Ancho de Banda de rodadura: 22 mm
Diámetro agujero pasante: 10 mm
Altura total: 108 mm
Radio de giro: 77 mm

Archivos CAD

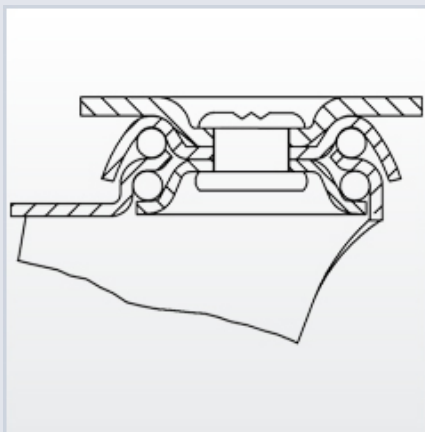

Rueda

PPI (Poliuretano)
Núcleo de poliamix y banda de poliuretano(95° shore A)
Rango de temperatura: -25° ÷ +80°

Productos relacionados

