

# Filter elements

## Type 1. and 2. Elements

**RE 51420**

Edition: 2014-05

Replaces: 10.10



HAD8040\_14

- ▶ Sizes according to **DIN 24550**: 0040 to 1000
- ▶ additional sizes: 0004 to 2500
- ▶ Differential pressure resistance up to 330 bar [to 4786 psi]
- ▶ Filter rating: 1 to 800  $\mu\text{m}$
- ▶ Filter area: up to 4.8 m<sup>2</sup> [to 7440 in<sup>2</sup>]
- ▶ Operating temperature: -10 °C to +100 °C [+14 °F to +212 °F]

### Features

- ▶ Filter media for numerous application ranges made of glass fiber material, filter paper, wire mesh, fleece material and metal fiber fleece
- ▶ Cleanable wire mesh filter media
- ▶ Attainable oil cleanliness up to ISO 12/8/3 (ISO 4406)
- ▶ High dirt holding capacity and filtration performance due to multi-layer glass fiber technology and simultaneously a low initial pressure differential (ISO 3968)
- ▶ Extended product range for non-mineral oil based fluids
- ▶ Filter elements with high pressure differential stability

### Contents

Features	1
Ordering code filter elements	2
Preferred types	8
Assignment of filter elements to filter series	9
Function, section	10
Filter variables	11
Technical data preferred program	13
Compatibility with permitted hydraulic fluids	14
Filter media	15
Assembly, commissioning, maintenance	24
Directives and standards	24

**Ordering code****Filter element****Filter element type 1.**

01	02	03	04	05	06	07	08
1.			-			-	0 -

**Filter element <sup>1)</sup>**

01	Design	1.
----	--------	----

**Size**

02	According to <b>DIN 24550</b>	0040 0063 0100 0160 0250 0400 0630 1000
	According to <b>Bosch Rexroth standard</b>	0045 0055 0120 0130 0150 0200 0270 2000 2500

**Filter rating in  $\mu\text{m}$** 

03	<b>Nominal</b>	Stainless steel wire mesh, cleanable	G10 G25 G40 G60 G100 G200 G500 G800
		Filter paper, one-way (not cleanable)	P10 P25
		Non-woven fabric, one-way (not cleanable)	VS25 VS40 VS60
	<b>Absolute (ISO 16889)</b>	Glass fiber material, one-way (not cleanable)	H1XL H3XL H6XL H10XL H20XL
		Metal fiber fleece, one-way (not cleanable)	M5 M10
	<b>Water absorbing <sup>2)</sup></b>	One-way (not cleanable)	AS3 AS6 AS10 AS20

**Pressure differential**

04	Maximum admissible pressure differential of the filter element: 30 bar [435 psi]	A
	Maximum admissible pressure differential of the filter element: 160 bar [2321 psi]	C

## Ordering code Filter element

### Filter element type 1.

01	02	03	04	05	06	07	08
<b>1.</b>			-			-	<b>0</b>

#### Element design

05	Adhesive	Standard adhesive	<b>0</b>
		Special adhesive <sup>3)</sup>	<b>H</b>

#### Element design

06	Material	Standard material	<b>0</b>
		Stainless steel 1,4571 <sup>4)</sup>	<b>V</b>

#### Bypass valve

07	<b>without</b> bypass valve	<b>0</b>
----	-----------------------------	----------

#### Seal

08	NBR seal	<b>M</b>
	FKM seal	<b>V</b>

<sup>1)</sup> Permissible temperature range see chapter "Technical data"

<sup>2)</sup> Only configurable with differential pressure A = 30 bar [435 psi]

<sup>3)</sup> Improved temperature and media resistance, only in conjunction with seal FKM "V"

<sup>4)</sup> Only in conjunction with special adhesive "H" and seal FKM "V"

#### Order example:

**1.0040 H10XL-A00-0-M**

**Material no.: R928005837**

**Other filter ratings and seal material upon request.**

## Ordering code

### Filter element

#### Filter element type 2.

01	02	03	04	05	06	07	08
2.			-			-	0 -

#### Filter element <sup>1)</sup>

01	Design	2.
----	--------	----

#### Size

02	According to <b>DIN 24550</b>	0040 0063 0100 0160 0250 0400 0630 1000
	According to <b>Bosch Rexroth standard</b>	0004 <sup>2)</sup> 0130 0150

#### Filter rating in $\mu\text{m}$

03	<b>Nominal</b>	Stainless steel wire mesh, cleanable	G10 G25 G40 G60 G100 G200 G500 G800
		Filter paper, one-way (not cleanable)	P10 P25
		Non-woven fabric, one-way (not cleanable)	VS25 VS40 VS60
	<b>Absolute (ISO 16889)</b>	Glass fiber material, one-way (not cleanable)	H1XL H3XL H6XL H10XL H20XL
		Metal fiber fleece, one-way (not cleanable)	M5 M10
	<b>Water absorbing</b> <sup>3)</sup>	One-way (not cleanable)	AS3 AS6 AS10 AS20

#### Pressure differential

04	Maximum admissible pressure differential of the filter element: 30 bar [435 psi]	A
	Maximum admissible pressure differential of the filter element: 330 bar [4786 psi]	B

## Ordering code Filter element

### Filter element type 2.

01	02	03	04	05	06	07	08
<b>2.</b>			-			-	<b>0</b>

#### Element design

05	Adhesive	Standard adhesive	<b>0</b>
		Special adhesive <sup>4)</sup>	<b>H</b>

#### Element design

06	Material	Standard material	<b>0</b>
		Stainless steel 1.4571 <sup>5)</sup>	<b>V</b>

#### Bypass valve

07	<b>without</b> bypass valve	<b>0</b>
----	-----------------------------	----------

#### Seal <sup>2)</sup>

08	NBR seal	<b>M</b>
	FKM seal	<b>V</b>

<sup>1)</sup> Permissible temperature range see chapter "Technical data"

<sup>2)</sup> Filter size 0003 = Filter element-size 0004

<sup>3)</sup> Only configurable with differential pressure A = 30 bar [435 psi]

<sup>4)</sup> Improved temperature and media resistance, only in conjunction with seal FKM "V"

<sup>5)</sup> Only in conjunction with special adhesive "H" and seal FKM "V"

#### Order example:

**2,0040 H10XL-A00-0-M**

**Material no.: R928006647**

**Other filter ratings and seal material upon request.**

## Ordering code

### Filter element

#### Filter element type 2.Z for sandwich plate filter 320PZR

01	02	03	04	05	06		
<b>2.Z</b>			-	<b>B00</b>	<b>0</b>	-	

#### Filter element <sup>1)</sup>

01	Design	<b>2.Z</b>
----	--------	------------

#### Size

02	According to <b>Bosch Rexroth standard</b>	<b>025</b> <b>075</b> <b>125</b>
----	--	--

#### Filter rating in µm

03	<b>Absolute (ISO 16889)</b> Glass fiber material, one-way (not cleanable)	<b>H3PZ</b> <b>H6PZ</b> <b>H10PZ</b> <b>H20PZ</b>
----	---	--

#### Pressure differential

04	Maximum admissible pressure differential of the filter element: 330 bar [4786 psi]	<b>B00</b>
----	--	------------

#### Bypass valve

05	<b>without</b> bypass valve	<b>0</b>
----	-----------------------------	----------

#### Seal <sup>1)</sup>

06	NBR seal	<b>M</b>
	FKM seal	<b>V</b>

<sup>1)</sup> Permissible temperature range see chapter "Technical data"

#### Order example:

**2.Z125 H10PZ-B00-0-M**

**Material no.: R928051781**

## Ordering code Filter element

Filter element Type 2.0058 and 2.0059  
for inline filter 16 FE and duplex filter 16 FD

01	02	03		04		05		06
2.			-	A00	-		-	

### Filter element <sup>1)</sup>

01	Design	2.
----	--------	----

### Size

02	According to <b>Bosch Rexroth standard</b>	0058 0059
----	--	--------------

### Filter rating in µm

03	<b>Nominal</b>	Stainless steel wire mesh, cleanable	G10 G25 G40 G60 G100 G200 G500 G800
		Filter paper, one-way (not cleanable)	P10 P25
		Non-woven fabric, one-way (not cleanable)	VS25 VS40 VS60
	<b>Absolute (ISO 16889)</b>	Glass fiber material, one-way (not cleanable)	H1XL H3XL H6XL H10XL H20XL
		Metal fiber fleece, one-way (not cleanable)	M5 M10
	<b>Water absorbing</b>	One-way (not cleanable)	AS3 AS6 AS10 AS20

### Pressure differential

04	Maximum admissible pressure differential of the filter element: 30 bar [435 psi]	A00
----	--	-----

### Bypass valve

05	<b>without</b> bypass valve	0
	<b>With</b> bypass valve – release pressure 3 bar [43.5 psi]	6

### Seal

06	NBR seal	M
	FKM seal	V

<sup>1)</sup> Permissible temperature range see chapter "Technical data"

**Order example:**  
**2,0058 H10XL-A00-6-M**

**Material no. R928007115**

**Other filter ratings and seal material upon request.**

## Preferred types

### Filter element Type 1. preferred types, NBR seal

Type	Material no. Filter element, Filter rating in $\mu\text{m}$		
	H3XL	H6XL	H10XL
1.0040 H..XL-A00-0-M	R928005835	R928005836	R928005837
1.0063 H..XL-A00-0-M	R928005853	R928005854	R928005855
1.0100 H..XL-A00-0-M	R928005871	R928005872	R928005873
1.0130 H..XL-A00-0-M	R928037178	R928045104	R928037180
1.0150 H..XL-A00-0-M	R928037181	R928037182	R928037183
1.0160 H..XL-A00-0-M	R928005889	R928005890	R928005891
1.0250 H..XL-A00-0-M	R928005925	R928005926	R928005927
1.0400 H..XL-A00-0-M	R928005961	R928005962	R928005963
1.0630 H..XL-A00-0-M	R928005997	R928005998	R928005999
1.1000 H..XL-A00-0-M	R928006033	R928006034	R928006035
1.2000 H..XL-A00-0-M	R928041312	R928048158	R928040797
1.2500 H..XL-A00-0-M	R928041314	R928046806	R928040800

### Filter element Type 2. preferred types, NBR seal

Type	Material no. Filter element, Filter rating in $\mu\text{m}$		
	H3XL	H6XL	H10XL
2.0040 H..XL-A00-0-M	R928006645	R928006646	R928006647
2.0063 H..XL-A00-0-M	R928006699	R928006700	R928006701
2.0100 H..XL-A00-0-M	R928006753	R928006754	R928006755
2.0130 H..XL-A00-0-M	R928022274	R928022275	R928022276
2.0150 H..XL-A00-0-M	R928022283	R928022284	R928022285
2.0160 H..XL-A00-0-M	R928006807	R928006808	R928006809
2.0250 H..XL-A00-0-M	R928006861	R928006862	R928006863
2.0400 H..XL-A00-0-M	R928006915	R928006916	R928006917
2.0630 H..XL-A00-0-M	R928006969	R928006970	R928006971
2.1000 H..XL-A00-0-M	R928007023	R928007024	R928007025

### Filter element Type 2.Z preferred types, NBR seal

Type	Material no. Filter element, Filter rating in $\mu\text{m}$		
	H3PZ	H6PZ	H10PZ
2.Z025 H...PZ-B00-0-M	R928051771	R928053299	R928051773
2.Z075 H...PZ-B00-0-M	R928051775	R928051776	R928051777
2.Z125 H...PZ-B00-0-M	R928051779	R928051780	R928051781

### Filter element Type 20058 and 2.0059 preferred types, NBR seal

Type	Material no. Filter element, Filter rating in $\mu\text{m}$		
	H3XL	H6XL	H10XL
2.0058 H...XL-A00-6-M	R928007113	R928007114	R928007115
2.0059 H...XL-A00-6-M	R928007131	R928007132	R928007133



## Assignment of filter elements to filter series

Element type (Type)	Series	Application	Data sheet no. <sup>1)</sup>
1.	40FLE(N)	Inline filters	51401
	100FLE(N)		51402
	40FLD(N)	Duplex filter	51408
	100FLD(N)		51409
	40FLDK(N)		51407
	63FLDK(N) -1X		51445
	10TE(N)	Tank mounted return line filters	51424
	10FRE(N)		51425
	10TD(N)-1X	Tank mounted return line filters, switchable	51454
	10 FRD(N)		not available

Element type (Type)	Series	Application	Data sheet no. <sup>1)</sup>
2.	40LE(N)	Inline filters	51400
	100LE(N)		51400
	50LE(N)		51447
	110LE(N)		51448
	245LE(N)		51421
	350LE(N)		51422
	445LEN		51423
	16FE		51403
	40LD(N)	Duplex filter	51406
	160LD(N)		51406
	50LD(N)		51453
	150LD(N)		51446
	400LD(N)		51429
	16FD		51410
	250/450FE(N)	Block mounting filters	51405
	245PSF(N)		51418
	350PSF(N)		51419
	450PBF(N)		51417

Element type (Type)	Series	Application	Data sheet no. <sup>1)</sup>
2.Z	320PZR	Sandwich plate filter	51427
	320PZR/PZL-2X	Sandwich plate filter, Generation 2X	51468

<sup>1)</sup> For further information please refer to the respective data sheet

## Function, section

The filter element is the central component of industrial filters. The actual filtration process takes part in the filter element. The main filter variables, such as size range of particle retention, dirt holding capacity and pressure loss are determined by the filter elements and the filter media used to construct them, Rexroth filter elements are used for filtration of hydraulic fluids in the hydraulic system as well as for the filtration of lubricants, industrial fluids and gases.

Filter elements consist of a combination of radially pleated filter media (3) which are laid around a perforated supporting tube (2). The filter element is vertically sealed with a two-component adhesive and the supporting tube and filter mat are connected to both end plates (1). One or two seal rings are provided between the filter element and the filter housing as a sealing.

Series 2.0058 and 2.0059 can be selected optionally with a bypass valve at the base of the filter element. The flow is generally from outside to inside.

All filter elements of the Rexroth preferred program are made of zinc-free components thus preventing the formation of zinc-soap, in particular if water-containing fluids (HFA/HFC) and synthetic oils are used.

The use of zinc-free filter elements prevents early “element blocking”, thus considerably increasing the life cycle of the elements.

Therefore, Rexroth filter elements can be used universally for typical hydraulic fluids and lubricants.

Moreover, many manufacturers of construction and agricultural machinery stipulate the use of zinc-free machine elements for rapidly bio-degradable hydraulic oils.

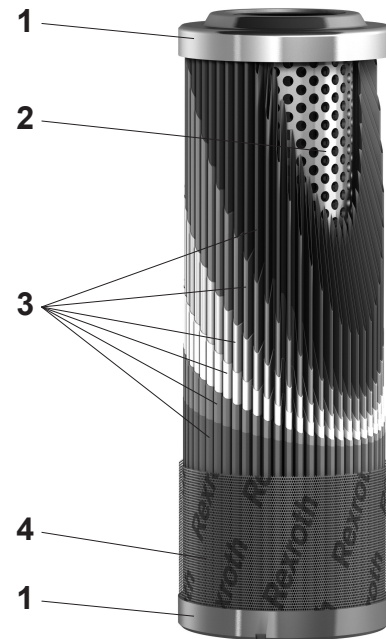

## Filter variables

### Filter rating and attainable oil cleanliness

The main goal when using industrial filters is not only the direct protection of machine components but to attain the required oil cleanliness. Oil cleanliness is defined on the

basis of oil cleanliness classes which classify how the amount of particles of the existing contamination is distributed in the operating liquid.

### Filtration performance

#### Filtration ratio $\beta_{x(c)}$ ( $\beta$ value)

The retention capacity of hydraulic filters against pollution in a hydraulic system is characterized by the filtration ratio  $\beta_{x(c)}$ . This ratio represents the major performance feature of hydraulic filters. It is measured in the multipass test, and is the average value of the specified initial and final pressure differential according to ISO 16889 using ISOMTD test dust.

The filtration quotient  $\beta_{x(c)}$  is defined as the quotient of the particle count of the respective particle size on both sides of the filter.

#### Dirt holding capacity

It is also measured using the multipass test and determines the amount of test dust ISOMTD which is fed to the filter medium until a specified pressure differential increase has been reached.

#### Pressure loss (also pressure differential or delta p)

The pressure loss of the filter element is the relevant characteristic value for the determination of the filter size. These are the recommended values of the filter manufacturer or specifications of the filter user. This value is dependent on many factors. These include for example: the rating of the filter media, its geometry and arrangement in the filter element, the filter area, the operating viscosity of the fluid and the flow.

The term "delta p" is often also expressed with the symbol: " $\Delta p$ "

When dimensioning the complete filter with a filter element, an initial pressure loss is determined which must not be exceeded by the new filter element based on the aforementioned conditions.

The dimensioning of a Rexroth filter element and the complete filter by means of initial  $\Delta p$  or  $\Delta p$  pressure loss can easily be carried out via our online program "BOSCH REXROTH FILTERSELECT".

The following diagram shows the typical pressure loss behavior of filter elements with different filter media at different flow rates.

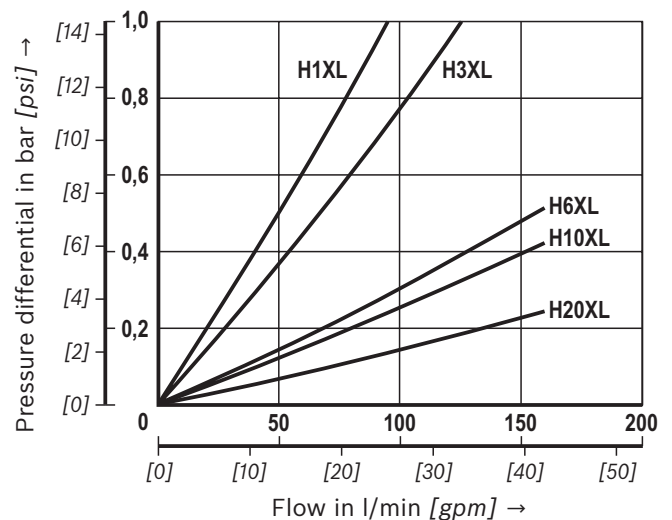
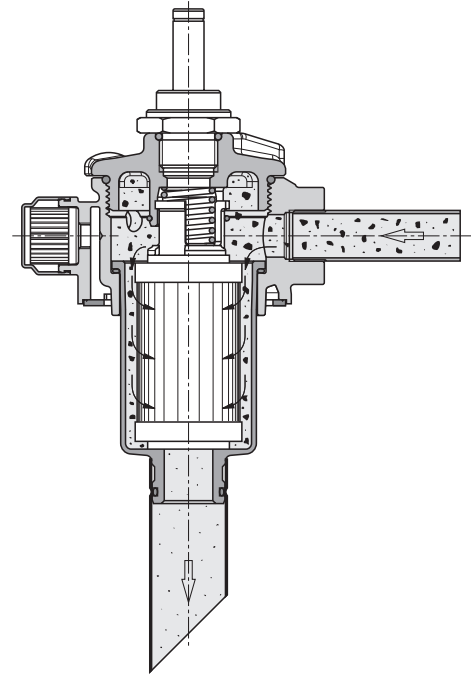

## Filter variables

### Overview

For the separation of particles different filter media in various ratings are used according to application and requirement.

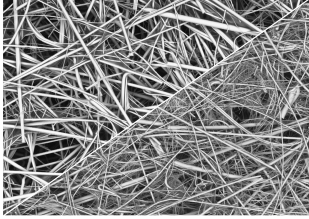
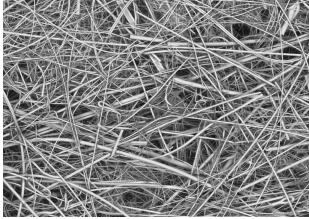
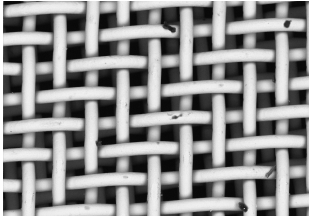
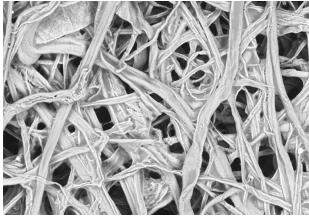
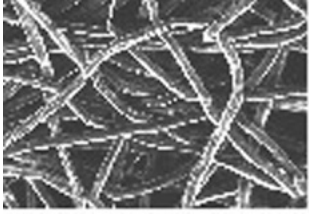
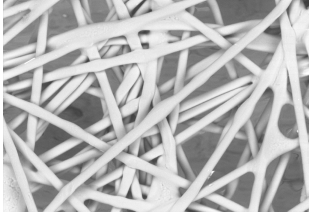
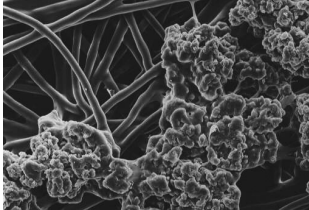
Filter medium/set-up	electron microscope image
<p><b>H...XL, Glass fiber material</b> Depth filter, combination of inorganic micro glass filter medium High dirt holding capacity due to multi-layer technology.</p>	
<p><b>H...PZ, Glass fiber material</b> Depth filter, combination of inorganic micro glass filter medium. Single-layer set-in variant by H...XL for use in sandwich plate filters.</p>	
<p><b>G..., Stainless steel wire mesh</b> <b>Material 1.4401 and 1.4571</b> Surface filter made of stainless steel wire mesh with supporting tissue.</p>	
<p><b>P..., Filter paper</b> Inexpensive depth filter made of filter paper with supporting tissue. Made of specially impregnated cellulose fiber preventing humidity and swelling.</p>	
<p><b>M..., Metal fiber fleece</b> <b>Material 1.4404</b> Depth filter made of stainless steel fibers with supporting mesh.</p>	
<p><b>VS..., Fleece material</b> Surface filter made of extremely solid fiber composite materials in the form of polyethylene-coated polypropylene fibers.</p>	
<p><b>AS..., water absorbing</b> Depth filter, fleece material with water absorbing material, combined with micro glass filter media.</p>	

**Technical data preferred program**

(For applications outside these parameters, please consult us!)

<b>General</b>							
Mass (1 Filter element) Net weights are based on glass fiber material	Size	<b>1.0040</b>	<b>1.0063</b>	<b>1.0100</b>	<b>1.0130</b>	<b>1.0150</b>	<b>1.0160</b>
	kg	0.16	0.24	0.38	0.59	0.67	0.74
	[lbs]	[0.35]	[0.53]	[0.83]	[1.30]	[1.47]	[1.63]
	Size	<b>1.0250</b>	<b>1.0400</b>	<b>1.0630</b>	<b>1.1000</b>	<b>1.2000</b>	<b>1.2500</b>
kg	1.075	1.48	2.42	3.44	4.8	9.14	
[lbs]	[2.36]	[3.26]	[5.33]	[7.58]	[10.58]	[20.15]	
Mass (2 Filter element) Net weights are based on glass fiber material	Size	<b>2.0040</b>	<b>2.0063</b>	<b>2.0100</b>	<b>2.0130</b>	<b>2.0150</b>	
	kg	0.1	0.175	0.28	0.29	0.32	
	[lbs]	[0.22]	[0.38]	[0.61]	[0.66]	[0.7]	
	Size	<b>2.0160</b>	<b>2.0250</b>	<b>2.0400</b>	<b>2.0630</b>	<b>2.1000</b>	
	kg	0.5	0.75	1.14	1.5	2.58	
	[lbs]	[1.1]	[1.65]	[2.51]	[3.31]	[5.68]	
	Size	<b>2.0058</b>	<b>2.0059</b>	<b>2.2025</b>	<b>2.2075</b>	<b>2.20125</b>	
	kg	3.4	3.8	0.09	0.16	0.3	
[lbs]	[7.7]	[8.5]	[0.2]	[0.35]	[0.66]		
Filtration direction	From the outside to the inside						
Ambient temperature range	°C [°F]	-10 ... +65 [+14...+149] (shortly down to -30 [-22])					
Storage conditions	- NBR seal	°C [°F]	-40 ... +65 [-40 ... +149]; max. relative air humidity 65 %				
	- FKM seal	°C [°F]	-20 ... +65[-4 ... +149]; max. relative air humidity 65 %				
Material	Differential pressure stability	bar [psi]	30 [435]		160 [2321]		330 [4786]
			Polyamide		Tin-coated steel		Tin-coated aluminum
	- Cover/Base						
	- Support tube	Tin-coated steel					
	- Seals	NBR or FKM					
<b>Hydraulic</b>							
Hydraulic fluid temperature range	°C [°F]	-10 ... +100 [+14... +212]					
Minimum conductivity of the medium	pS/m	300					

<b>Material</b>	<b>Code letter</b>	<b>Operating temperature range °C [°F]</b>
<b>Seal</b>		
NBR	M	-40 to +100 [-40 to +212]
FKM	V	-20 to +210 [-4 to +410]
<b>Filter element adhesive</b>		
Standard	O	-40 to +100 [-40 to +212]
Special	H	-55 to +170 [-67 to +338]
<b>Filter element material (cover, base, support tube)</b>		
Standard	O	-40 to +100 [-40 to +212]
Stainless steel	V	-55 to +170 [-67 to +338]
<b>Filter element material (Filter material)</b>		
Aquasorb	AS...	0 to +160 [32 to +320]
Stainless steel wire mesh	G...	-55 to +500 [-67 to +932]
glass fiber material	H...XL	to +160 [to +320]
Metal fiber fleece	M...	-55 to +250 [-67 to +482]
Filter paper	P...	to +130 [to +266]
Fleece material	VS...	to +80 [to +176]

## Compatibility with permitted hydraulic fluids

Hydraulic fluid	Classification	Suitable sealing materials	Standards
Mineral oil	HLP	NBR	DIN 51524
Biodegradable	– insoluble in water	HETG	VDMA 24568
		HEES	
	– soluble in water	HEPG	VDMA 24568
Flame-resistant	– water-free	HFDU, HFDR	VDMA 24317
	– containing water	HFAS	DIN 24320
		HFAE	
	HFC	NBR	VDMA 24317

### Important information on hydraulic fluids:

- For more information and data on the use of other hydraulic fluids, please refer to data sheet 90220 or contact us!
- **Flame-resistant – containing water:** due to possible chemical reactions with materials or surface coatings of machine and system components, the service life with these hydraulic fluids may be less than expected.

Filter materials made of filter paper (cellulose) may not be used, filter elements with glass fiber material have to be used instead.

- **Biodegradable:** If filter materials made of filter paper are used, the filter life may be shorter than expected due to material incompatibility and swelling.

## Filter media

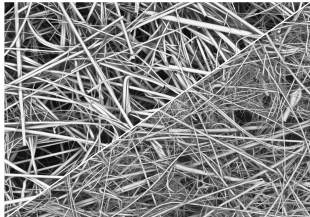
Technical data	H...XL
<p><b>Glass fiber fleece, H...XL</b></p> <p>The filter medium achieves the best possible degree of purity compared to other filter media. It is suitable for fluids such as hydraulic oils, lubricants, chemical and industrial liquids. Due to its designed retention capacity (ISO 16889), it offers therefore highly effective protection for machine and system components which are sensitive to contamination.</p> <ul style="list-style-type: none"> <li>- H...XL depth filter made of inorganic glass fiber material</li> <li>- Absolute filtration/defined retention capacity according to ISO 16889</li> <li>- High dirt holding capacity due to multi-layer set-up</li> <li>- Non-reusable filter (not cleanable due to the depth filtration effect)</li> <li>- Attainable oil cleanliness classes according to ISO 4406 up to ISO code 12/8/3 and better</li> </ul>	
<p><b>Filter rating and attainable oil cleanliness</b></p> <p>The following table provides recommendations for the selection of a filter medium in dependency of the application and indicates the average oil cleanliness class attainable according to ISO 4406 or SAE-AS 4059.</p>	

### glass fiber material

Contamination class DIN ISO 4406	to be achieved with filter			Hydraulic system	
	$\beta_{x(c)} = 200$	Material	Possible arrangement		
10/6/4 - 14/8/6	1 $\mu\text{m}$	Glass fiber material H...XL	Pressure filter	-----	Special applications
13/10/8 - 17/13/10	3 $\mu\text{m}$			-----	Servo valves
15/12/10 - 19/14/11	6 $\mu\text{m}$			-----	High-response valves
17/14/10 - 21/16/13	10 $\mu\text{m}$			---	Proportional valves
19/16/12 - 22/17/14	20 $\mu\text{m}$			-	General pumps and valves
			Return flow or pressure filters.		

### Achievable filtration ratio $\beta_{x(c)}$ ( $\beta$ value)

Typical  $\beta$  values of up to 2.2 bar [31.9 psi]  $\Delta p$  pressure increase at the filter element <sup>1)</sup>

Filter medium	Particle size "x" for various $\beta$ values, measurement according to ISO 16889		
	$\beta_{x(c)} \geq 75$	$\beta_{x(c)} \geq 200$	$\beta_{x(c)} \geq 1000$
H1XL	< 4.0 $\mu\text{m}(c)$	< 4.0 $\mu\text{m}(c)$	< 4.0 $\mu\text{m}(c)$
H3XL	4.0 $\mu\text{m}(c)$	< 4.5 $\mu\text{m}(c)$	5.0 $\mu\text{m}(c)$
H6XL	4.8 $\mu\text{m}(c)$	5.5 $\mu\text{m}(c)$	7.5 $\mu\text{m}(c)$
H10XL	6.5 $\mu\text{m}(c)$	7.5 $\mu\text{m}(c)$	9.5 $\mu\text{m}(c)$
H20XL	18.5 $\mu\text{m}(c)$	20.0 $\mu\text{m}(c)$	22.0 $\mu\text{m}(c)$

<sup>1)</sup> Filtration ratio  $\beta_{x(c)}$  for other filter media upon request

### Filtration ratio $\beta_{x(c)}$ as a function of the particle size $\mu\text{m}(c)$

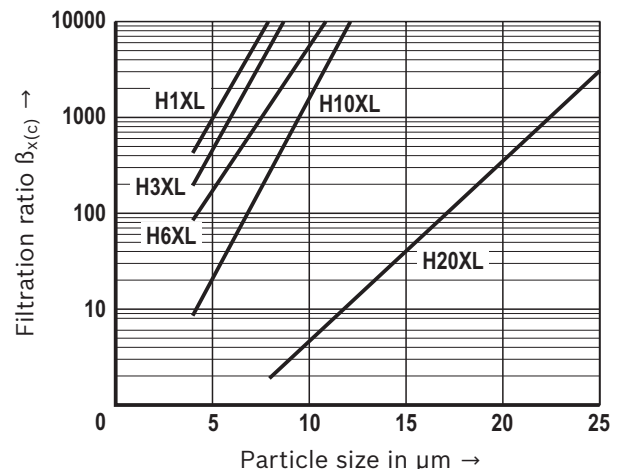



## Filter media

### Technical data

H...XL

#### Dirt holding capacity

Compared to conventional filter media with insertion technology, the filter material H...XL features a high dirt holding capacity because it is made of two separate filter layers connected in series.

**Conventional filter element**  (single-layer glass fiber material)  
**Rexroth H...XL filter element**  (multi-layer glass fiber material)

#### Superior dirt holding capacity of H...XL filter elements

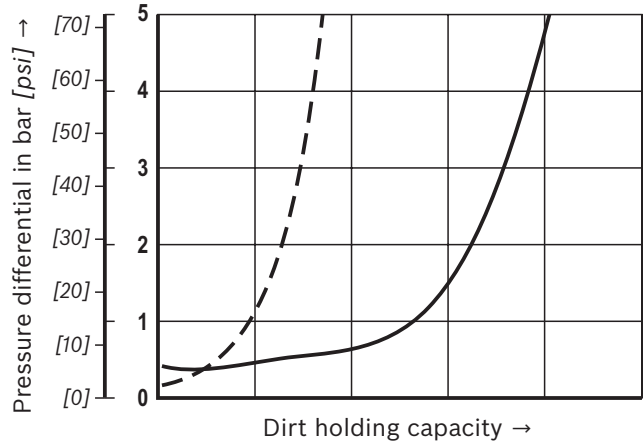

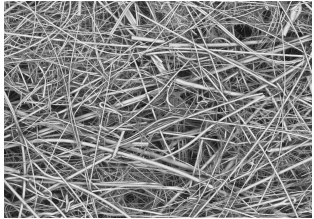

## Filter media

Technical data	H...PZ
<p><b>Glass fiber material, H...PZ</b>                      The filter medium achieves the best possible degree of purity compared to other filter media. It is suitable for hydraulic oil. Due to its designed retention capacity (ISO 16889), it offers therefore highly effective protection for machine and system components which are sensitive to contamination.</p> <ul style="list-style-type: none"> <li>- Depth filter made of inorganic glass fiber material</li> <li>- Absolute filtration/defined retention capacity according to ISO 16889</li> <li>- Non-reusable filter (not cleanable due to the depth filtration effect)</li> <li>- Attainable oil cleanliness classes according to ISO 4406 up to ISO code 12/8/3 and better</li> </ul>	
<p><b>Filter rating and attainable oil cleanliness</b>                      The following table provides recommendations for the selection of a filter medium in dependency of the application and indicates the average oil cleanliness class attainable according to ISO 4406 or SAE-AS 4059.</p>	

### glass fiber material

Contamination class DIN ISO 4406	to be achieved with filter			Hydraulic system
	$\beta_{x(c)} = 200$	Material	Possible arrangement	
13/10/8 - 17/13/10	3 $\mu\text{m}$	Glass fiber material H...PZ	Sandwich plate filter 320PZ...	----- - Vertical stacking (Sandwich plate mounting)
15/12/10 - 19/14/11	6 $\mu\text{m}$			
17/14/10 - 21/16/13	10 $\mu\text{m}$			
19/16/12 - 22/17/14	20 $\mu\text{m}$			

### Achievable filtration ratio $\beta_{x(c)}$ ( $\beta$ value)

Typical  $\beta$  values of up to 2.2 bar [31.9 psi]  $\Delta p$  pressure increase at the filter element <sup>1)</sup>

Filter medium	Particle size "x" for different $\beta$ values, measurement according to ISO 16889		
	$\beta_{x(c)} \geq 75$	$\beta_{x(c)} \geq 200$	$\beta_{x(c)} \geq 1000$
<b>H3PZ</b>	4.0 $\mu\text{m}(c)$	< 4.5 $\mu\text{m}(c)$	5.0 $\mu\text{m}(c)$
<b>H6PZ</b>	4.8 $\mu\text{m}(c)$	5.5 $\mu\text{m}(c)$	7.5 $\mu\text{m}(c)$
<b>H10PZ</b>	6.5 $\mu\text{m}(c)$	7.5 $\mu\text{m}(c)$	9.5 $\mu\text{m}(c)$
<b>H20PZ</b>	18.5 $\mu\text{m}(c)$	20.0 $\mu\text{m}(c)$	22.0 $\mu\text{m}(c)$

<sup>1)</sup> Filtration ratio  $\beta_{x(c)}$  for other filter media upon request

Filtration ratio  $\beta_{x(c)}$  as a function of the particle size  $\mu\text{m}(c)$

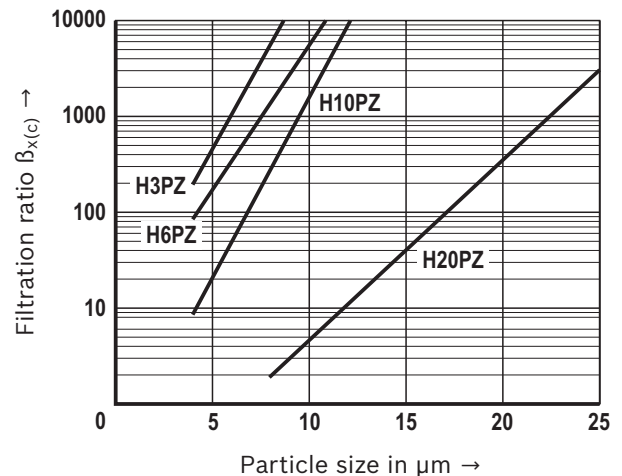

## Filter media

### Technical data

G...

#### Stainless steel wire mesh, G...

There is a comprehensive field of applications for wire mesh filter media. Not only pre-filtration is possible, but also the filtration of lubricating oils, hydraulic oils, coolants and water-like fluids.

#### Wire mesh G10 ... G40

As surface filters, these materials are generally cleanable. Due to their fine mesh, however, cleaning is more difficult than with coarser filter mesh.

Therefore, we recommend cleaning the filters in an ultrasonic bath.

#### Wire mesh G60 ... G800

Due to their coarser mesh size, the cleaning of these filters media is easier.

- Surface filter made of stainless steel wire mesh
- Reusable, cleanable
- Pleated version: single, two or three-layer design

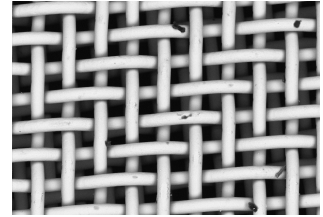

Filter medium	Version	Mesh size
G10	Special Dutch weave	10 µm nom.
G25	Body mesh	25 µm nom.
G40		40 µm nom.
G60 ... G800	Plain woven cloth	60 ... 800 µm nom.

### Stainless steel wire mesh

Contamination class DIN ISO 4406	to be achieved with filter			Fluid system
	nominal	Material	Possible arrangement	
20/18/13 - 21/20/15	10 µm	Stainless steel wire mesh, G...	Pressure filter	----- For production facilities (hydraulic) and as a protection filter (G10, G25)  All fluids e.g.: - Lubricant - Petrochemical - Water filter - Refrigeration/Thermo oil
Not applicable for wire mesh > 10 µm	25 ... 800 µm		Return flow pressure filters or suction filters	

## Filter media

### Technical data

G...

### Cleaning of filter elements

#### Cleaning or replacement

Before cleaning a G...- element, the filter element has to be dismantled first and then checked whether it makes sense to clean the element. For example, if the cloth contains many fibrous substances and consists of a material finer than G40, effective and complete cleaning is not possible in many cases. Filter mesh which has visible defects due to frequent cleaning must be replaced. In general, the following applies: The finer the cloth, the thinner the wire. Therefore, especially fine mesh must be cleaned gently to protect the material. Cracks in the folds of the wire mesh and the metal fiber fleece are to be avoided. Otherwise, the filter capacity will be insufficient.

#### Cleaning frequency

Experience has shown that filter elements made of G10, G25 and G40 can be cleaned up to ten times.

Filter mesh > 60 µm can usually be cleaned more than ten times. Reusability, however, very much depends on the type of contamination as well as on pressurization (final  $\Delta p$  before dismantling the filter element). For maximum reusability, we therefore recommend replacing in particular the fine mesh and the M material at a final  $\Delta p$  of 2.2 bar [31.9 psi] at the latest. Due to the given reasons, the aforementioned values must be regarded as reference values for which we do not assume any liability.

## Recommendations for cleaning

### Manual and simple cleaning method for G... elements

Procedure	Wire mesh G10, G25, G40	Wire mesh G60 ... G800
Chemical pre-cleaning	Let the filter element drain for approx. 1 hour after disassembly. Bathe in solvent afterwards.	
Mechanical pre-cleaning	Remove rough dirt with a brush or scrubber. Do not use any hard or pointed objects which could damage the filter medium.	
Mechanical/chemical main cleaning	Put pre-cleaned element in an ultrasonic bath with special solvent. Clean the element in the ultrasonic bath until any visible contamination is removed.	Steam with hot wash solution (Water with corrosion protection agent)
test	Visually inspect the material for damage. Replace the filter element if you identify obvious damages.	
Preservation	After drying, you must spray the cleaned element with preservative agents and store it sealed against dust in a plastic foil.	

### Automated cleaning for G... elements

Procedure	Wire mesh G10, G25, G40, G60 ... G800
Chemical pre-cleaning	Let the filter element drain for approx. 1 hour after disassembly. Bathe in solvent afterwards.
Mechanical/chemical main cleaning	By means of special cleaning systems for filter elements. Most of these systems are provided with a fully automated and combined cleaning mechanism including ultrasound as well as mechanical and chemical cleaning processes. This allows for best possible cleaning results with gentle cleaning processes.

## Filter media

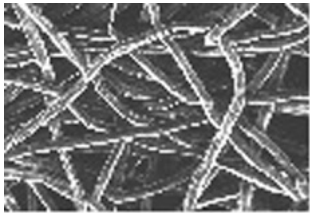
Technical data	M...
<p><b>Metal fiber fleece, M...</b>                      Metal fiber fleece is used to achieve high purity levels for special fluids or high operating temperatures. It provides effective protection for dirt-sensitive machine parts through absolute filtration. Since this material is made from stable and tightly bound interwoven stainless steel fibres, it counts as a depth filter media and is classified as not cleanable.</p> <ul style="list-style-type: none"> <li>- Absolute filtration, measurement according to ISO 16889</li> <li>- Depth filter made of stainless steel fibers</li> <li>- non-reusable filter</li> <li>- Oil cleanliness classes according to ISO 4406 up to an ISO cleanliness class from 15/13/10 and better</li> <li>- Pleated version: two or three-layer design</li> <li>- Supporting mesh: Epoxy or stainless steel wire mesh</li> </ul>	

Filter medium	Particle size for filtration ratio > 75 <sup>1)</sup>
M5	5 µm
M10	10 µm

<sup>1)</sup> according to ISO 16889

### Metal fiber fleece

Contamination class DIN ISO 4406	to be achieved with filter			Hydraulic system
	$\beta_{x(e)} = 75$	Material	Possible arrangement	
16/13/10 - 20/15/11	5 µm	Metal fiber fleece M...	Return flow or pressure filters.	----- Filter material for special applications (non-hydraulic)
18/14/10 - 21/17/13	10 µm			

## Filter media

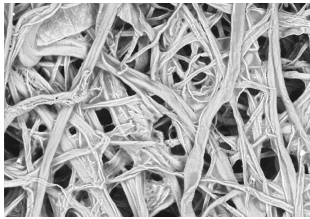
Technical data	P...
<p><b>Filter paper, P...</b> Filter paper is used for the filtration of lubricating oil and for pre-filtration. Filter paper has the following features:</p> <ul style="list-style-type: none"> <li>- Depth filter made of cellulose fibers</li> <li>- Specially impregnated against swelling caused by humidity</li> <li>- Pleated version: single, two or three-layer design</li> <li>- Non-reusable filter (not cleanable due to the depth filtration effect)</li> </ul>	

Filter medium	Nominal filter rating	Filtration ratio $\beta$ values <sup>1)</sup>	Retention rate <sup>1)</sup>
<b>P10</b>	10 $\mu\text{m}$	$\beta_{10(c)} > 2.0$	50 %
<b>P25</b>	25 $\mu\text{m}$	$\beta_{10(c)} > 1.25$	20 %

<sup>1)</sup> according to ISO 16889

### Filter paper

Contamination class DIN ISO 4406	to be achieved with filter			Hydraulic system
	$\beta_{x(c)} = 200$	Material	Possible arrangement	
20/19/14 - 22/20/15	10 $\mu\text{m}$	Paper P...	Return flow or pressure filters.	----- For production facilities
21/20/15 - 22/21/16	25 $\mu\text{m}$			

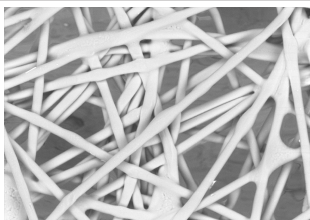
Technical data	VS...
<p><b>Fleece material, VS...</b> The fleece material VS... serves for filtration of coolants, water and aqueous media. It is also possible to use this filter media for the filtration of emulsions or generally for pre-filtration.</p> <ul style="list-style-type: none"> <li>- Depth filter material made of polyolefin fibers</li> <li>- Binder-free</li> <li>- Thermofixed</li> <li>- Extremely tear-resistant</li> <li>- Pleated version: single or two-layer design</li> <li>- Supporting mesh: epoxy-coated or stainless steel wire mesh</li> <li>- Non-reusable filter (not cleanable due to the depth filtration effect)</li> </ul>	

Filter medium	Nominal filter rating
<b>VS 25</b>	25 $\mu\text{m}$
<b>VS 40</b>	40 $\mu\text{m}$
<b>VS 60</b>	60 $\mu\text{m}$

## Filter media

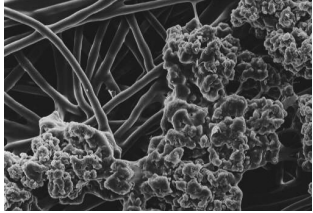
Technical data	AS...
<p><b>Water absorbing, AS...</b>            AS ... <b>Aquasorb</b> Filter elements adsorb humidity from ventilation filters as well as free water in hydraulic fluids and lubricating oils. Even at low concentration above the saturation point of the oil water can accelerate oil aging through oxidation. This results in increased corrosion and increased wear and tear. In certain oil additives it can also cause a change or a failure in the form of solid, mucus-like substances which then prematurely clog the pores of the filter. With a combination of glass fiber filter media a highly effective separation of dirt is additionally given</p> <ul style="list-style-type: none"> <li>- Absolute filtration ISO 16889</li> <li>- Surface filter made of water absorbent filter fleece</li> <li>- Combined with glass fiber</li> <li>- Non-reusable filter (not cleanable due to the depth filtration effect)</li> <li>- Pleated version: multi layer design</li> </ul>	

Filter medium	Particle size $\beta_{x(c)} = 200$ <sup>1)</sup>	Particle size $\beta_{x(c)} = 1000$ <sup>1)</sup>
AS3	4.5 $\mu\text{m}(c)$	5.0 $\mu\text{m}(c)$
AS6	5.5 $\mu\text{m}(c)$	7.5 $\mu\text{m}(c)$
AS10	7.5 $\mu\text{m}(c)$	9.5 $\mu\text{m}(c)$
AS20	20 $\mu\text{m}(c)$	22 $\mu\text{m}(c)$

<sup>1)</sup> according to ISO 16889

## Aquasorb

Contamination class DIN ISO 4406	to be achieved with filter			Hydraulic system	
	$\beta_{x(c)} = 200$	Material	Possible arrangement		
13/10/8 - 17/13/10	3 $\mu\text{m}$	AS...	Return flow, bypass or ventilation filters.	-----	Servo valves
15/12/10 - 19/14/11	6 $\mu\text{m}$			-----	High-response valves
17/14/10 - 21/16/13	10 $\mu\text{m}$			---	Proportional valves
19/16/12 - 22/17/14	20 $\mu\text{m}$			-	General pumps and valves

## Functional principle

Rexroth Aquasorb filter elements are pleated just as Rexroth industrial filter elements, however, contain a layer of fleece material on a water-binding fabric. This is in the form of a fine granulate. The corresponding glass fiber is combined behind this fleece material, depending on the filter rating.

## Effectiveness

The effectiveness of the Rexroth Aquasorb elements has been proven through internal testing and by a scientific study in an independent institute. The water content (free water) can be reduced to the saturation point of the oil. The effectiveness and the water absorption are dependent on the load on filter area, the viscosity of the oil and the oil temperature. The values of water absorption and the change at higher viscosities are specified below.

## Filter media

Technical data				AS...
Type	Calculated water absorption			
	at 15 cst in ml	at 30 cst in ml	at 46 cst in ml	at 120 cst in ml
1.0040	60	40	35	20
1.0063	100	70	55	35
1.0100	160	110	90	60
1.0130	225	155	130	85
1.0150	360	250	210	135
1.0160	265	185	155	100
1.0250	435	305	255	165
1.0400	785	550	455	300
1.0630	1290	900	750	490
1.1000	1435	1005	830	545
1.2000	2785	1950	1615	1055
1.2500	3650	2555	2115	1385

Type	Calculated water absorption			
	at 15 cst in ml	at 30 cst in ml	at 46 cst in ml	at 120 cst in ml
2.0040	35	25	20	15
2.0063	55	40	30	20
2.0100	90	65	50	35
2.0130	110	75	65	40
2.0150	145	105	85	55
2.0160	200	140	115	75
2.0250	325	225	190	125
2.0400	525	370	305	200
2.0630	715	500	415	270
2.1000	835	585	485	315
2.0058	1545	1080	895	585
2.0059	1790	1250	1035	680

## Assembly, commissioning, maintenance

### When has the filter element to be replaced or cleaned?

As soon as the dynamic pressure or the pressure differential set at the maintenance indicator is reached, the red push button of the optical-mechanical maintenance indicator pops out. In addition an electrical signal is given if an electronic switching element is present. In this case, the filter element must be replaced or cleaned.

Filter elements should be replaced or cleaned after max. 6 months.

### Filter element exchange

- ▶ For single filters:  
Switch off the system and discharge the filter on the pressure side.
- ▶ For installed duplex switch filters:  
Refer to the relevant maintenance instructions according to the data sheet.

Detailed instructions with regard to the exchange of filter elements can be found on the data sheet of the relevant filter series.

### WARNING!

- ▶ Filters are containers under pressure. Before opening the filter housing, check whether the system pressure in the filter has been decreased to ambient pressure.

Only then may the filter housing be opened for maintenance.

### Notice:

- ▶ From a cold start the preset optical maintenance indicator signal may be exceeded due to the high viscosity.  
After reaching the operating temperature the mechanical optical display can be acknowledged manually. The electrical signal will go out after the operating temperature has been reached.  
If the maintenance indicator signal is ignored,

the disproportionately increasing pressure differential may damage the filter element causing it to collapse.

- ▶ Warranty becomes void if the delivered item is changed by the ordering party or third parties or improperly mounted, installed, maintained, repaired, used or exposed to environmental condition that do not comply with the installation conditions.

## Directives and standards

Rexroth filter elements are tested and quality-monitored according to different ISO test standards:

Filtration performance test (multipass test)	ISO 16889:2008-06
$\Delta p$ (pressure loss) characteristic curves	ISO 3968:2001-12
Compatibility with hydraulic fluid	ISO 2943:1998-11
collapse pressure test	ISO 2941:2009-04

The development, manufacture and assembly of Rexroth industrial filters and Rexroth filter elements is carried out within the framework of a certified quality management system in accordance with ISO 9001:2000.

Bosch Rexroth AG  
Werk Ketsch  
Hardtwaldstr. 43  
68775 Ketsch, Germany  
Telefon +49 (0) 62 02 / 603-0  
filter-support@boschrexroth.de  
www.boschrexroth.de

© Alle Rechte bei Bosch Rexroth AG, auch für den Fall von Schutzrechtsanmeldungen. Jede Verfügungsbefugnis, wie Kopier- und Weitergaberecht, bei uns. Die angegebenen Daten dienen allein der Produktbeschreibung. Eine Aussage über eine bestimmte Beschaffenheit oder eine Eignung für einen bestimmten Einsatzzweck kann aus unseren Angaben nicht abgeleitet werden. Die Angaben entbinden den Verwender nicht von eigenen Beurteilungen und Prüfungen. Es ist zu beachten, dass unsere Produkte einem natürlichen Verschleiß- und Alterungsprozess unterliegen.