

EVC219

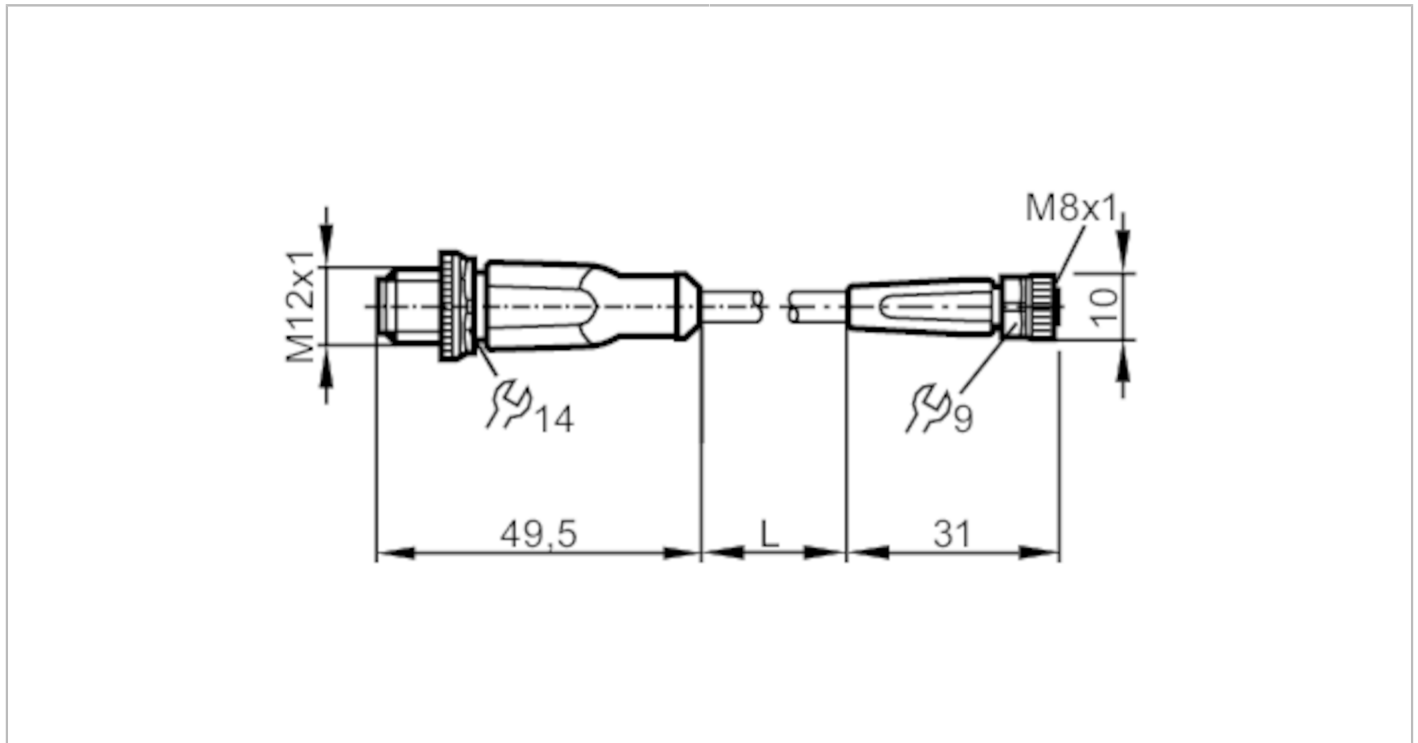

Connection cable

VDOG F030MSS0005H03STGH030MSS



Application		
Special feature	Free from silicone; Halogen-free; Gold-plated contacts; Drag chain suitability	
Free from silicone	yes	
Electrical data		
Operating voltage [V]	< 50 AC / < 60 DC	
Protection class	III	
Max. current load total [A]	3	
Operating conditions		
Ambient temperature [°C]	-25...90	
Note on ambient temperature	cULus: ...75	
Ambient temperature (moving) [°C]	-25...90	
Note on ambient temperature (moving)	cULus: ...75	
Protection	IP 65; IP 67; IP 68; IP 69K	
Mechanical data		
Weight [g]	152.1	
Materials	housing: TPU orange; Sealing: FKM	
Material nut	brass, nickel-plated / brass, nickel-plated	
Drag chain suitability	yes	
Drag chain suitability	bending radius for flexible use	min. 10 x cable diameter
	travel speed	max. 3.3 m/s for a horizontal travel length of 5 m and max. acceleration of 5 m/s ²
	bending cycles	> 5 Mio.
	torsional strain	± 180 °/m

EVC219



Connection cable

VDOGF030MSS0005H03STGH030MSS

Remarks

Notes	Please see the technical note under "Downloads"
Pack quantity	1 pcs.

Electrical connection - plug

Connector: 1 x M12, straight; Locking: brass, nickel-plated; Contacts: gold-plated; Tightening torque: 0.6...1.5 Nm



Electrical connection

Cable: 5 m, PUR, Halogen-free, black, Ø 4.3 mm; 3 x 0.34 mm² (42 x Ø 0.1 mm)

Connection

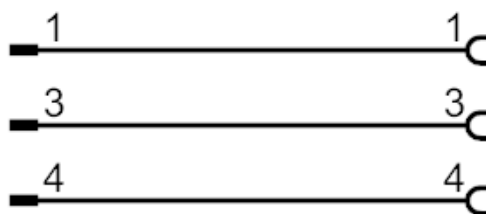

Electrical connection - socket

Connector: 1 x M8, straight; Locking: brass, nickel-plated; Contacts: gold-plated; Tightening torque: 0.3...0.5 Nm

