



CIRCUIT-BREAKER SZ S0, FOR MOTOR PROTECTION, CLASS 10, W. OVERLOAD RELAY FUNCTION A-RELEASE 18...25A, N-RELEASE 325 A, SCREW CONNECTION, STANDARD SW. CAPACITY

product brand name		SIRIUS
Product designation		3RV2 circuit breaker

**General technical data:**

<b>Active power loss total typical</b>	W	8
<b>Insulation voltage</b>		
• with degree of pollution 3 Rated value	V	690
<b>Shock resistance</b>		
• acc. to IEC 60068-2-27		25g / 11 ms
<b>Surge voltage resistance Rated value</b>	kV	6
<b>Mechanical service life (switching cycles)</b>		
• of the main contacts typical		100 000
• of the auxiliary contacts typical		100 000
<b>Electrical endurance (switching cycles)</b>		
• typical		100 000
<b>Temperature compensation</b>	°C	-20 ... +60
<b>Size of contactor can be combined company-specific</b>		S0
<b>Protection class IP</b>		
• on the front		IP20
• of the terminal		IP20
<b>Type of protection</b>		Increased safety
<b>Equipment marking</b>		
• acc. to DIN EN 81346-2		Q

**Main circuit:**

<b>Number of poles for main current circuit</b>		3
---	--	---

<b>Adjustable response value current of the current-dependent overload release</b>	A	18 ... 25
<b>Operating voltage</b>		
• Rated value	V	690
• at AC-3 Rated value maximum	V	690
Operating frequency Rated value	Hz	50 ... 60
<b>Operating current Rated value</b>	A	25
<b>Operating current</b>		
• at AC-3		
— at 400 V Rated value	A	25
<b>Operating power</b>		
• at AC-3		
— at 230 V Rated value	W	5 500
— at 400 V Rated value	W	11 000
— at 500 V Rated value	W	15 000
— at 690 V Rated value	W	22 000
<b>Operating frequency</b>		
• at AC-3 maximum	1/h	15

#### Auxiliary circuit:

<b>Number of NC contacts</b>		
• for auxiliary contacts		0
<b>Number of NO contacts</b>		
• for auxiliary contacts		0
<b>Number of CO contacts</b>		
• for auxiliary contacts		0
<b>Product expansion Auxiliary switch</b>		Yes
<b>Design of the auxiliary switch</b>		laterally
<b>Operating current of the auxiliary contacts at AC-15</b>		
• at 24 V	A	1.5
• at 230 V	A	1.5
<b>Operating current of the auxiliary contacts at DC-13</b>		
• at 24 V	A	1

#### Protective and monitoring functions:

<b>Trip class</b>		CLASS 10
<b>Design of the overload circuit breaker</b>		thermal
<b>Operational short-circuit current breaking capacity (Ics) with AC</b>		
• at 240 V Rated value	kA	100
• at 400 V Rated value	kA	25
• at 500 V Rated value	kA	5
• at 690 V Rated value	kA	2
<b>Maximum short-circuit current breaking capacity (Icu)</b>		

<ul style="list-style-type: none"> <li>• with AC at 240 V Rated value</li> <li>• with AC at 400 V Rated value</li> <li>• with AC at 500 V Rated value</li> <li>• with AC at 690 V Rated value</li> </ul>	kA	100
	kA	55
	kA	10
	kA	4
<b>Breaking capacity short-circuit current (I<sub>cn</sub>)</b>		
<ul style="list-style-type: none"> <li>• with 1 current path for DC at 150 V Rated value</li> </ul>	kA	10
<ul style="list-style-type: none"> <li>• with 2 current paths in series for DC at 300 V Rated value</li> </ul>	kA	10
<ul style="list-style-type: none"> <li>• with 3 current paths in series for DC at 450 V Rated value</li> </ul>	kA	10
<b>Response value current of the instantaneous short-circuit release</b>	A	325

#### UL/CSA ratings:

<b>Full-load current (FLA) for three-phase AC motor</b>		
<ul style="list-style-type: none"> <li>• at 480 V Rated value</li> </ul>	A	25
<ul style="list-style-type: none"> <li>• at 600 V Rated value</li> </ul>	A	25
<b>yielded mechanical performance [hp]</b>		
<ul style="list-style-type: none"> <li>• for single-phase AC motor at 110/120 V Rated value</li> </ul>	metric hp	2
<ul style="list-style-type: none"> <li>• for single-phase AC motor at 230 V Rated value</li> </ul>	metric hp	3
<ul style="list-style-type: none"> <li>• for three-phase AC motor at 200/208 V Rated value</li> </ul>	metric hp	5
<ul style="list-style-type: none"> <li>• for three-phase AC motor at 220/230 V Rated value</li> </ul>	metric hp	7.5
<ul style="list-style-type: none"> <li>• for three-phase AC motor at 460/480 V Rated value</li> </ul>	metric hp	15
<b>Contact rating of the auxiliary contacts acc. to UL</b>		C600 / R300

#### Short-circuit:

<b>Product function Short circuit protection</b>		Yes
<b>Design of the short-circuit trip</b>		magnetic
<b>Design of the fuse link</b>		
<ul style="list-style-type: none"> <li>• for short-circuit protection of the auxiliary switch required</li> </ul>		fuse gL/gG: 6 A, quick: 10 A
<b>Design of the fuse link for IT network for short-circuit protection of the main circuit</b>		
<ul style="list-style-type: none"> <li>• at 400 V</li> <li>• at 500 V</li> <li>• at 690 V</li> </ul>		gL/gG 63 A gL/gG 50 A gL/gG 50 A

#### Installation/ mounting/ dimensions:

<b>mounting position</b>		any
<b>Mounting type</b>		screw and snap-on mounting onto 35 mm standard mounting rail according to DIN EN 60715

<b>Height</b>	mm	97
<b>Width</b>	mm	65
<b>Depth</b>	mm	96
<b>Required spacing</b>		
<ul style="list-style-type: none"> <li>• with side-by-side mounting <ul style="list-style-type: none"> <li>— forwards</li> <li>— Backwards</li> <li>— upwards</li> <li>— downwards</li> <li>— at the side</li> </ul> </li> <li>• for grounded parts <ul style="list-style-type: none"> <li>— forwards</li> <li>— Backwards</li> <li>— upwards</li> <li>— at the side</li> <li>— downwards</li> </ul> </li> <li>• for live parts <ul style="list-style-type: none"> <li>— forwards</li> <li>— Backwards</li> <li>— upwards</li> <li>— downwards</li> <li>— at the side</li> </ul> </li> </ul>	mm	0 0 50 50 0  0 0 50 30 50  0 0 50 50 30

Connections/ Terminals:		
<b>Type of electrical connection</b>		
<ul style="list-style-type: none"> <li>• for main current circuit</li> <li>• for auxiliary and control current circuit</li> </ul>		screw-type terminals screw-type terminals
<b>Arrangement of electrical connectors for main current circuit</b>		Top and bottom
<b>Product function</b>		No
<ul style="list-style-type: none"> <li>• removable terminal for auxiliary and control circuit</li> </ul>		
<b>Type of connectable conductor cross-section</b>		
<ul style="list-style-type: none"> <li>• for main contacts <ul style="list-style-type: none"> <li>— single or multi-stranded</li> <li>— finely stranded with core end processing</li> </ul> </li> <li>• for AWG conductors for main contacts</li> <li>• for auxiliary contacts <ul style="list-style-type: none"> <li>— single or multi-stranded</li> <li>— finely stranded with core end processing</li> </ul> </li> <li>• for AWG conductors for auxiliary contacts</li> </ul>		2x (1 ... 2,5 mm <sup>2</sup> ), 2x (2,5 ... 10 mm <sup>2</sup> ) 2x (1 ... 2.5 mm <sup>2</sup> ), 2x (2.5 ... 6 mm <sup>2</sup> ), 1x 10 mm <sup>2</sup> 2x (16 ... 12), 2x (14 ... 8)  2x (0,5 ... 1,5 mm <sup>2</sup> ), 2x (0,75 ... 2,5 mm <sup>2</sup> ) 2x (0.5 ... 1.5 mm <sup>2</sup> ), 2x (0.75 ... 2.5 mm <sup>2</sup> ) 2x (20 ... 16), 2x (18 ... 14)
<b>Tightening torque</b>		
<ul style="list-style-type: none"> <li>• for main contacts with screw-type terminals</li> </ul>	N·m	2 ... 2.5

<b>Design of screwdriver shaft</b>		Diameter 5 to 6 mm
<b>Design of the thread of the connection screw</b>		
<ul style="list-style-type: none"> <li>• for main contacts</li> </ul>	%	M4
<ul style="list-style-type: none"> <li>• of the auxiliary and control contacts</li> </ul>	%	M3

#### Safety related data:

<b>B10 value with high demand rate acc. to SN 31920</b>		50 000
<b>Proportion of dangerous failures</b>		
<ul style="list-style-type: none"> <li>• with low demand rate acc. to SN 31920</li> </ul>	%	40
<ul style="list-style-type: none"> <li>• with high demand rate acc. to SN 31920</li> </ul>	%	40
<b>Failure rate [FIT] with low demand rate acc. to SN 31920</b>	FIT	50
<b>T1 value for proof test interval or service life acc. to IEC 61508</b>	y	10
<b>Protection against electrical shock</b>		finger-safe

#### Mechanical data:

<b>Size of the circuit-breaker</b>		S0
------------------------------------	--	----





#### Ambient conditions:

<b>Installation altitude at height above sea level maximum</b>	m	2 000
<b>Ambient temperature</b>		
<ul style="list-style-type: none"> <li>• during operation</li> </ul>	°C	-20 ... +60
<ul style="list-style-type: none"> <li>• during storage</li> </ul>	°C	-50 ... +80
<ul style="list-style-type: none"> <li>• during transport</li> </ul>	°C	-50 ... +80
<b>Relative humidity during operation</b>	%	10 ... 95



#### Display:

<b>Display version</b>		
<ul style="list-style-type: none"> <li>• for switching status</li> </ul>		Handle

#### Certificates/ approvals:

General Product Approval			Declaration of Conformity	Test Certificates	
 CCC	 CSA		 EG-Konf.	<a href="#">Special Test Certificate</a>	<a href="#">Type Test Certificates/Test Report</a>

Shipping Approval					
 ABS	 BUREAU VERITAS	 DNV	 GL	 LRS	 PRS

Shipping Approval		other			
 RINA	 RMRS	<a href="#">Confirmation</a>	<a href="#">Environmental Confirmations</a>	 VDE	<a href="#">other</a>

#### Further information

**Information- and Downloadcenter (Catalogs, Brochures,...)**

<http://www.siemens.com/industrial-controls/catalogs>

**Industry Mall (Online ordering system)**

<http://www.siemens.com/industrymall>

**Cax online generator**

<http://support.automation.siemens.com/WW/CAXorder/default.aspx?lang=en&mlfb=3RV21214DA10>

**Service&Support (Manuals, Certificates, Characteristics, FAQs,...)**

<http://support.automation.siemens.com/WW/view/en/3RV21214DA10/all>

**Image database (product images, 2D dimension drawings, 3D models, device circuit diagrams, EPLAN macros, ...)**

[http://www.automation.siemens.com/bilddb/cax\\_de.aspx?mlfb=3RV21214DA10&lang=en](http://www.automation.siemens.com/bilddb/cax_de.aspx?mlfb=3RV21214DA10&lang=en)

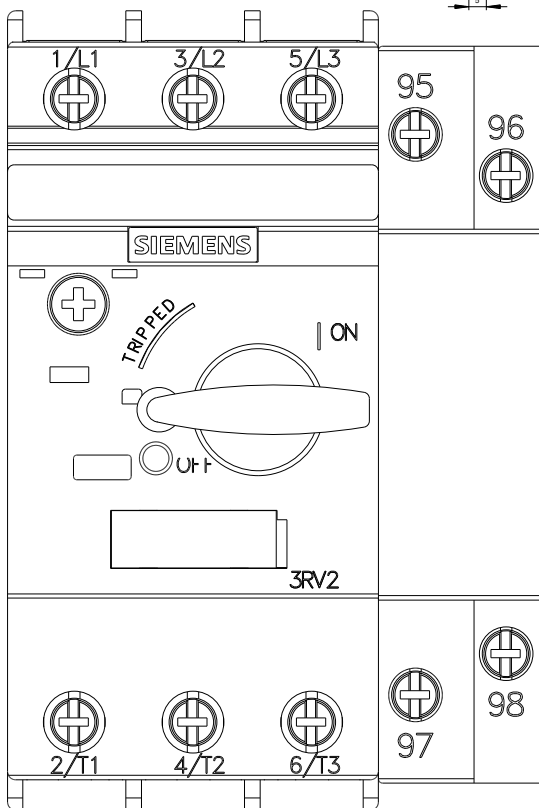
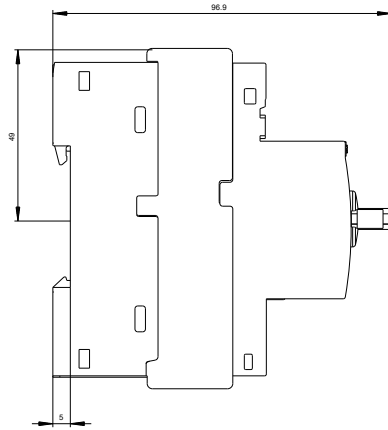
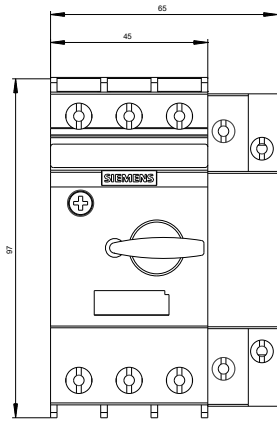

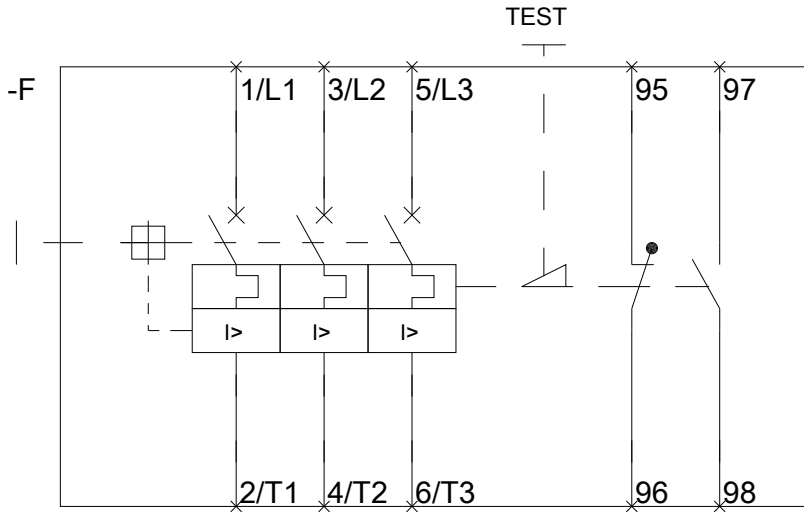

last modified:

11.03.2015