

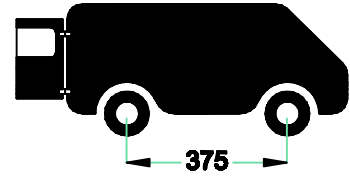

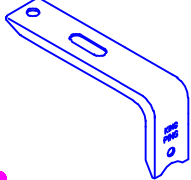

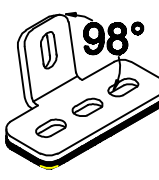

FORD TRANSIT 2014

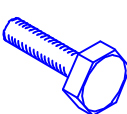
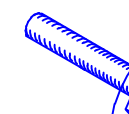

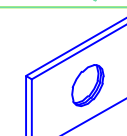
320x173 cm L3 H2

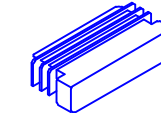

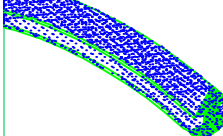
 8x	 8x
 24x Max. 20Nm	 8x Max. 20Nm
 32x	 24x Max. 20Nm
 24x	 8x
 16x	 4x

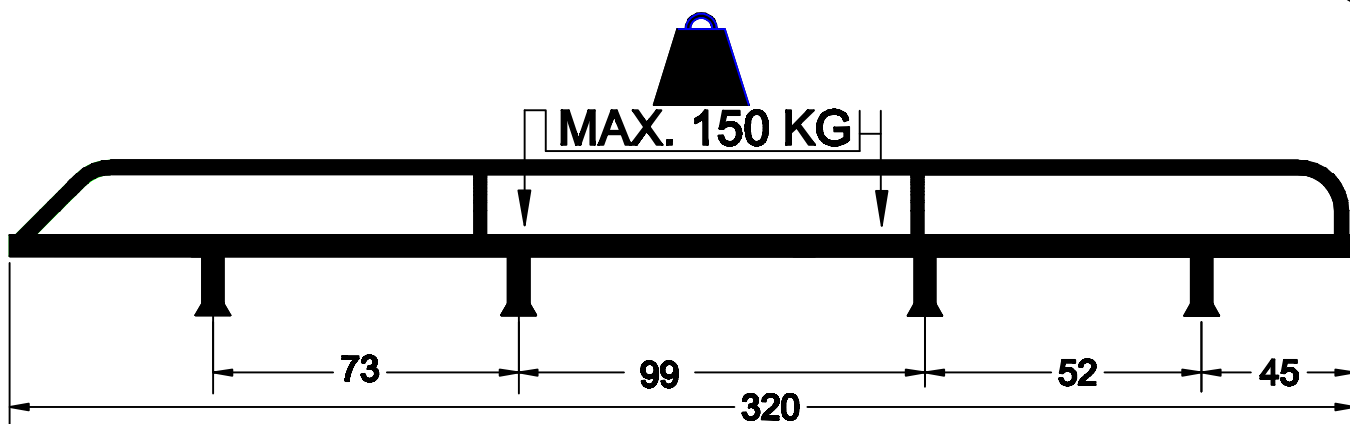
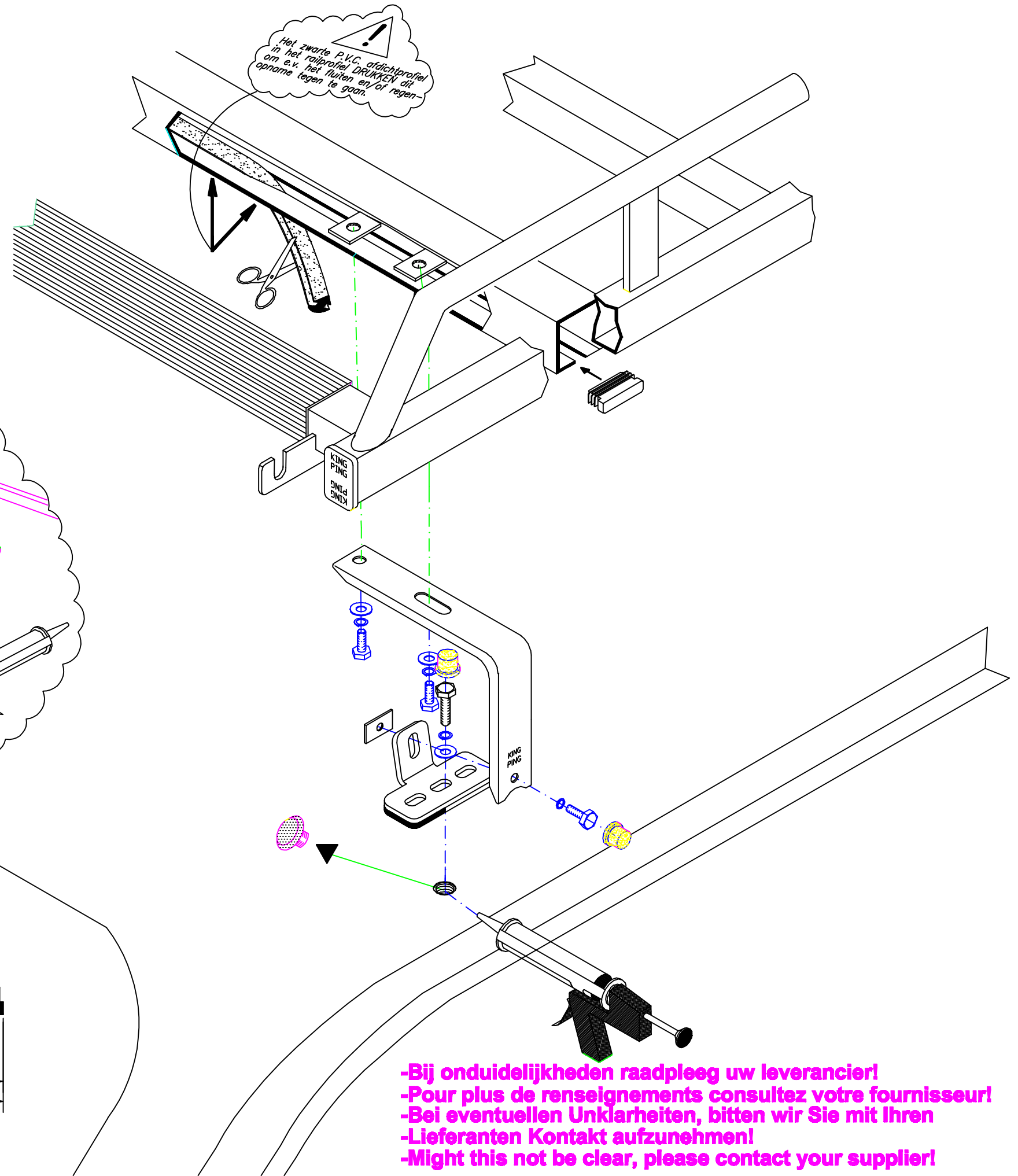
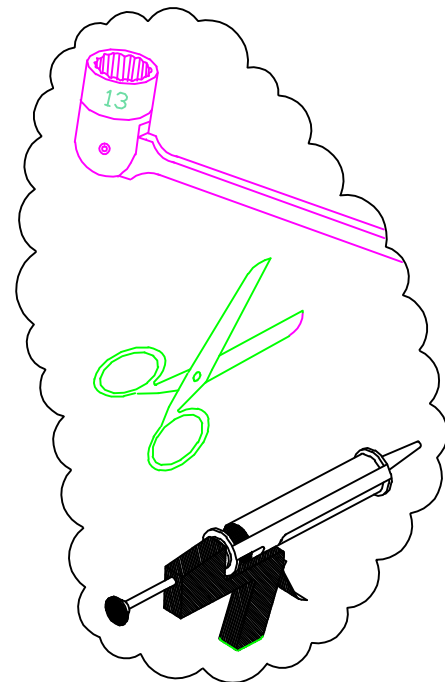

3211 FTL3H2 320173S 12/2015