

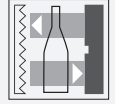

Retroreflective sensor (glass)

OBG5000-R100-2EP1-IO-0,3M-V1



- Miniature design with versatile mounting options
- Detects transparent objects, i.e., clear glass, PET and transparent films
- Two machines in one: clear object detection or reflection operating mode with long range
- High degree of protection IP69K
- IO-Link interface for service and process data

Retroreflective sensor with polarization filter for clear object detection



Function

The R100 series miniature optical sensors are the first devices of their kind to offer an end-to-end solution in a small single standard design — from thru-beam sensor through to a distance measurement device. As a result of this design, the sensors are able to perform practically all standard automation tasks.

The entire series enables sensors to communicate via IO-Link.

The DuraBeam laser sensors are durable and can be used in the same way as a standard sensor.

The use of Multi Pixel Technology gives the standard sensors a high level of flexibility and enables them to adapt more effectively to their operating environment.

Dimensions

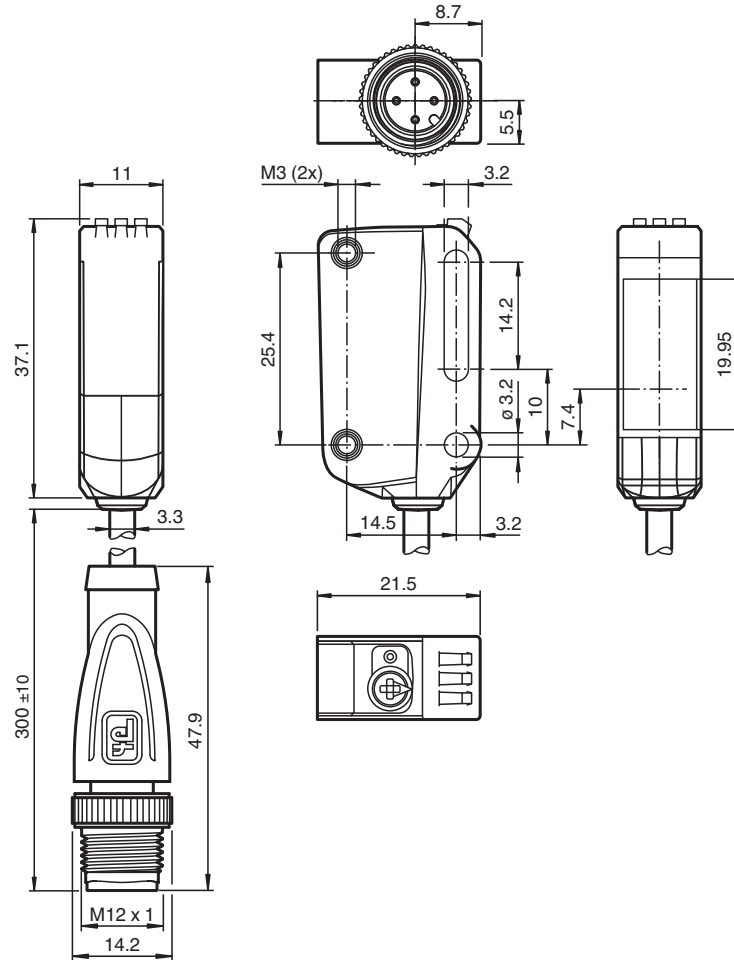

Technical Data

General specifications

Effective detection range	0 ... 3.5 m in TEACH mode ; 0 ... 5 m at switch position "N"
Reflector distance	0 ... 3.5 m in TEACH mode ; 0 ... 5 m at switch position "N"
Threshold detection range	6 m
Reference target	H85-2 reflector
Light source	LED
Light type	modulated visible red light
LED risk group labelling	exempt group
Diameter of the light spot	approx. 170 mm at a distance of 3.5 m
Angle of divergence	approx. 5 °
Ambient light limit	EN 60947-5-2

Functional safety related parameters

MTTF _d	600 a
Mission Time (T _M)	20 a
Diagnostic Coverage (DC)	0 %

Indicators/operating means

Operation indicator	LED green: constantly on - power on flashing (4Hz) - short circuit flashing with short break (1 Hz) - IO-Link mode
Function indicator	Yellow LED: Permanently lit - light path clear Permanently off - object detected Flashing (4 Hz) - insufficient operating reserve
Control elements	Teach-In key

Release date: 2021-09-07 Date of issue: 2021-09-07 Filename: 267075-100480_eng.pdf

Refer to "General Notes Relating to Pepperl+Fuchs Product Information".

 Pepperl+Fuchs Group
www.pepperl-fuchs.com

 USA: +1 330 486 0001
fa-info@us.pepperl-fuchs.com

 Germany: +49 621 776 1111
fa-info@de.pepperl-fuchs.com

 Singapore: +65 6779 9091
fa-info@sg.pepperl-fuchs.com

Technical Data

Control elements	5-step rotary switch for operating modes selection	
Contrast detection levels	10 % - clean, water filled PET bottles 18 % - clear glass bottles 40 % - colored glass or opaque materials Adjustable via rotary switch	
Electrical specifications		
Operating voltage	U_B	10 ... 30 V DC
Ripple	max. 10 %	
No-load supply current	I_0	< 25 mA at 24 V supply voltage
Protection class	III	
Interface		
Interface type	IO-Link (via C/Q = pin 4)	
IO-Link revision	1.1	
Device ID	0x110A07 (1116679)	
Transfer rate	COM2 (38.4 kBaud)	
Min. cycle time	2.3 ms	
Process data width	Process data input 2 Bit Process data output 2 Bit	
SIO mode support	yes	
Compatible master port type	A	
Output		
Switching type	The switching type of the sensor is adjustable. The default setting is: C/Q - Pin4: NPN normally closed / light-on, PNP normally open / dark-on, IO-Link /Q - Pin2: NPN normally open / dark-on, PNP normally closed / light-on	
Signal output	2 push-pull (4 in 1) outputs, short-circuit protected, reverse polarity protected, overvoltage protected	
Switching voltage	max. 30 V DC	
Switching current	max. 100 mA , resistive load	
Usage category	DC-12 and DC-13	
Voltage drop	U_d	≤ 1.5 V DC
Switching frequency	f	500 Hz
Response time	1 ms	
Conformity		
Communication interface	IEC 61131-9	
Product standard	EN 60947-5-2	
Approvals and certificates		
EAC conformity	TR CU 020/2011	
UL approval	E87056 , cULus Listed , class 2 power supply , type rating 1	
Ambient conditions		
Ambient temperature	-20 ... 60 °C (-4 ... 140 °F) , movable cable not appropriate for conveyor chains	
Storage temperature	-40 ... 70 °C (-40 ... 158 °F)	
Mechanical specifications		
Housing width	11 mm	
Housing height	37.1 mm	
Housing depth	21.5 mm	
Degree of protection	IP67 / IP69 / IP69K	
Connection	300 mm fixed cable with M12 x 1, 4-pin connector	
Material		
Housing	PC (Polycarbonate)	
Optical face	PMMA	
Mass	approx. 17 g	
Cable length	0.3 m	

Release date: 2021-09-07 Date of issue: 2021-09-07 Filename: 267075-100480_eng.pdf

Connection

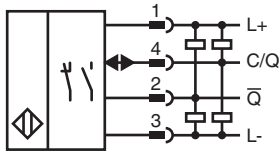

Connection Assignment

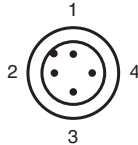

Wire colors in accordance with EN 60947-5-2

1	BN	(brown)
2	WH	(white)
3	BU	(blue)
4	BK	(black)

Assembly

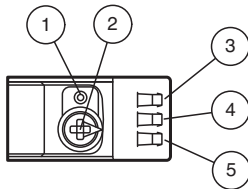

1	Teach-in button
2	Mode rotary switch
3	Operating indicator / dark on
4	Signal indicator
5	Operating indicator / light on

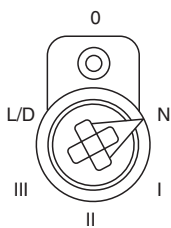

N	Normal mode
I	10 % contrast detection
II	18 % contrast detection
III	40 % contrast detection
L/D	Switching type
0	Keylock

Release date: 2021-09-07 Date of issue: 2021-09-07 Filename: 267075-100480_eng.pdf

Characteristic Curve

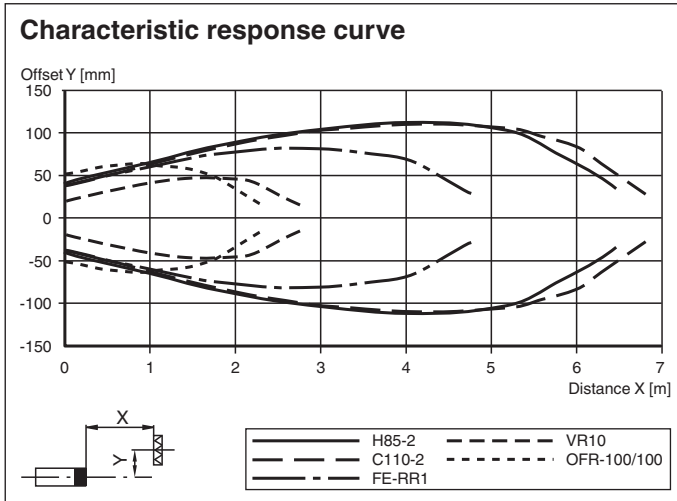

Relative received light strength in switch position "N"

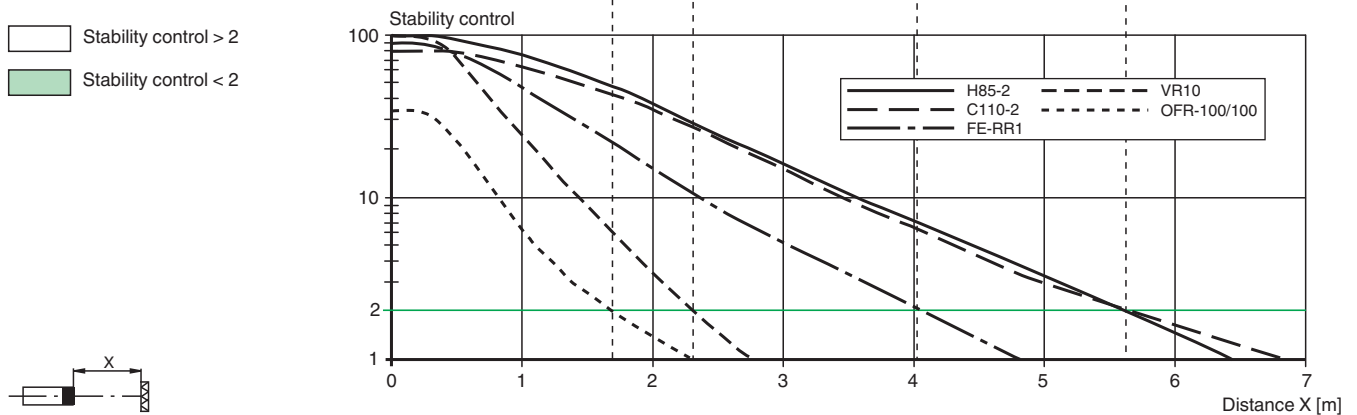
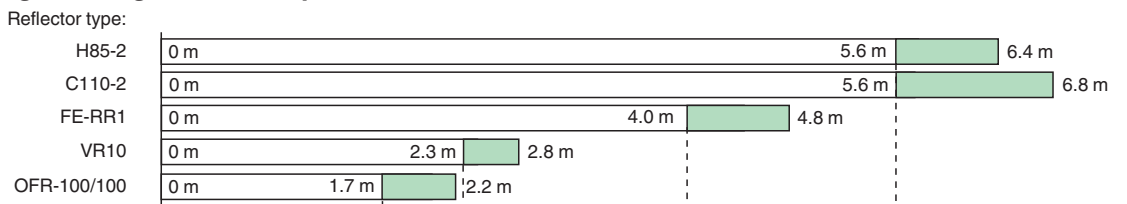

Commissioning

Teach-in

Use the rotary switch to select the required operating mode: Normal mode (N) or contrast level I – III. To teach in a threshold or activate an operating mode, press the "TI" button until the yellow and green LEDs flash in phase (approx. 1 s). Release the "TI" button. Teach-in starts. Successful teach-in is indicated by alternating flashing (2.5 Hz) of the yellow and green LEDs. The sensor will now operate in the selected operating mode with the taught-in threshold. An unsuccessful teach-in is indicated by rapidly alternating flashing (8 Hz) of the yellow and green LEDs. After an unsuccessful teach-in, the sensor continues to operate with the previous valid setting after the relevant visual fault signal is issued. Every taught-in switching threshold can be re-taught (overwritten) by pressing the "TI" button again. Note: To ensure that the device functions reliably in Contrast mode, the device must be powered on at least 30 s before teach-in.

Setting the Device to Maximum Sensitivity

- Use the rotary switch to select the Normal mode (N) position.
 - Press the "TI" button for > 4 s. The yellow and green LEDs will go out.
 - Release the "TI" button.
- The settings will be reset to maximum sensitivity. After successfully resetting, the yellow and green LEDs will flash alternately (2.5 Hz).

Switching between light on/dark on







- Use the rotary switch to select the light on/dark on (L/D) position.
- Press the "TI" button for > 1 s. The respective operating indicator LED (L/D) will illuminate green and the switching type will change.
- To reset the switching type, press the "TI" button for > 4 s. The respective operating indicator LED (L/D) will illuminate green and the operating indicator will be reset to the most recently active switching type.

Reset to Default Settings

Release date: 2021-09-07 Date of issue: 2021-09-07 Filename: 267075-100480_eng.pdf

- Use the rotary switch to select the O position.
- Press the "TI" button for > 10 s. The yellow and the green LEDs will both switch off.
- Release the "TI" button. The yellow LED is on. After resetting, the sensor will operate with the following default settings:

Accessories

	V31-WM-2M-PUR	Female cordset single-ended M8 angled A-coded, 4-pin, PUR cable grey
	V31-GM-2M-PUR	Female cordset single-ended M8 straight A-coded, 4-pin, PUR cable grey
	REF-H85-2	Reflector, rectangular 84.5 mm x 84.5 mm, mounting holes
	REF-H50	Reflector, rectangular 51 mm x 61 mm, mounting holes, fixing strap
	REF-H33	Reflector with screw fixing
	OFR-100/100	Reflective tape 100 mm x 100 mm
	IO-Link-Master02-USB	IO-Link master, supply via USB port or separate power supply, LED indicators, M12 plug for sensor connection