

Ambient Light Sensor

3mm T-1

ALS-PDIC144-6C/L378

Features

- Close responsively to the human eye spectrum
- Light to Current, analog output
- Good output linearity across wide illumination range
- Low sensitivity variation across various light sources
- Operation temperature performance, -30°C to 85°C
- Wide supply voltage range, 1.8V to 5.5V
- Size: 5mm Lamp (Flat lens)
- RoHS compliant and Pb free package

Description

The ALS-PDIC144-6C/L378 is an ambient light sensor, which incorporates a photodiode and a current amplifier IC in DIP package. EVERLIGHT ALS series products are a good effective solution to the power saving of display backlighting of mobile appliances, such as the mobile phones, NB and PDAs. Due to the high rejection ratio of infrared radiation, the spectral response of the ambient light sensor is close to human eyes.

Applications

- Detection of ambient light to control display backlighting
 - Mobile devices – Mobile phones, PDAs
 - Computing device – TFT LCD monitor for Notebook computer
 - Consumer device – TFT LCD TV, Video camera, Digital camera, Toys
- Automatic residential and commercial management
- Automatic contrast enhancement for electronic signboard
- Ambient light monitoring device for daylight and artificial light
 - Street light, CCD/CCTV



Package Dimensions

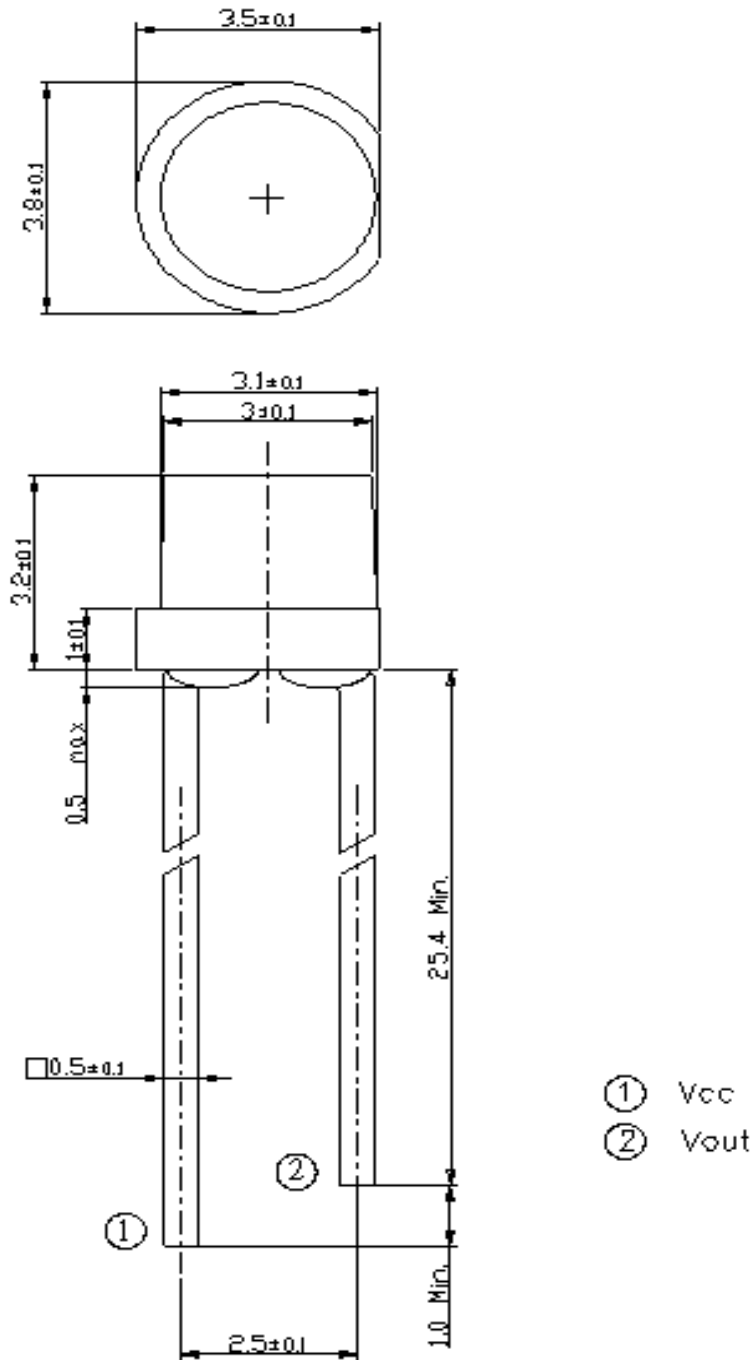

Notes: 1.All dimensions are in millimeters
2.Tolerances unless dimensions ± 0.1 mm

Absolute Maximum Ratings

Parameter	Symbol	Rating	Unit
Supply Voltage	V_{CC}	-0.7 ~ 6.5	V
Operating Temperature Range	T_a	-30 ~ +85	°C
Storage Temperature Range	T_s	-40 ~ +100	°C
Soldering Temperature Range	T_{SOL}	260	°C

Recommended Operating Conditions

Parameter	Symbol	Min.	Max.	Unit
Operating Temperature	T_a	-30	+85	°C
Supply Voltage	V_{CC}	1.8	5.5	V

EVERLIGHT

Electrical and Optical Characteristics ($T_a=25$)

Parameter	Symbol	MIN	TYP	MAX.	Unit	Test Condition
Dark Current	I_D	1	---	100	nA	$V_{CC}=3V, E_v= 0Lux$
Light Current	I_{PH1}	2.2	---	4.4	uA	$V_{CC}=3V, E_v= 10Lux$
	I_{PH2}	22	---	44	uA	$V_{CC}=3V, E_v= 100Lux$ [Note1]
	I_{PH3}	220	---	440	uA	$V_{CC}=3V, E_v= 1000Lux$ [Note1]
	I_{PH4}	264	---	528	mA	$V_{CC}=3V, E_v= 1000Lux$ [Note2]
Photocurrent Ratio	I_{PH4} / I_{PH3}	---	1.2	---	---	$V_{CC}=3V, E_v= 1000Lux$
Peak Sensitivity Wavelength	λ_p	---	550	---	nm	---
Sensitivity Wavelength Range	λ	390	---	700	nm	---
Rise time	t_r	---	0.36	---	ms	$V_{CC}=3V$ $R_L = 27K\Omega$
Fall time	t_f	---	1.13	---	ms	
Angle of half Sensitivity	$2\theta_{1/2}$	---	143	---	Deg.	$I_F = 20 mA$

Note:

1. White Fluorescent light (Color Temperature = 6500K) is used as light source. However, White LED is substituted in mass production.
2. Illuminance by CIE standard illuminant-A / 2856K, incandescent lamp.

Typical Electrical and Optical Characteristics Curves

Fig.1 Light Current vs. illuminance

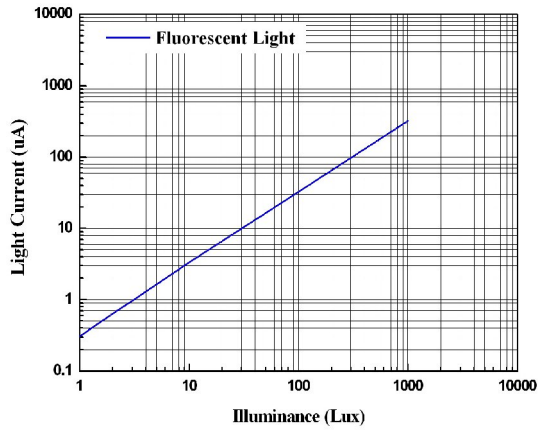

Fig.2 Output Voltage vs. illuminance

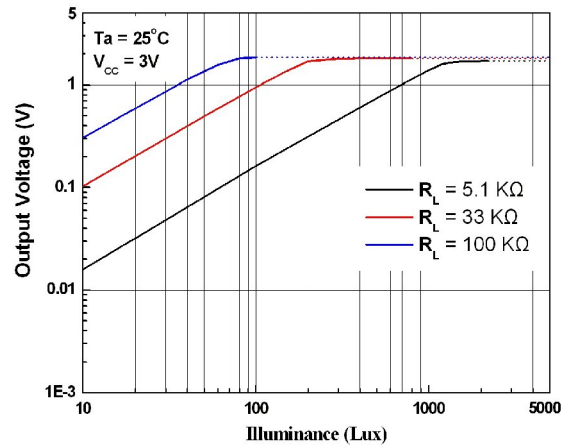

Fig.3 Spectral Response

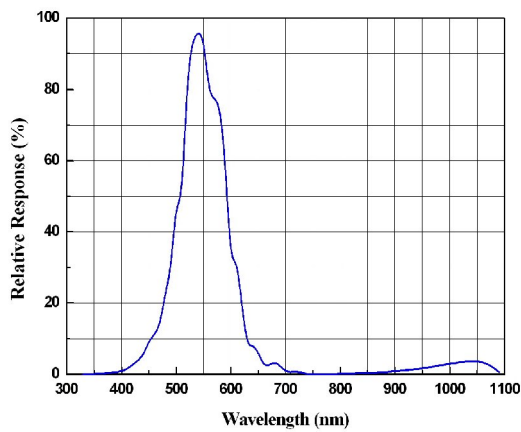

Fig.4 Light current vs. Supply Voltage

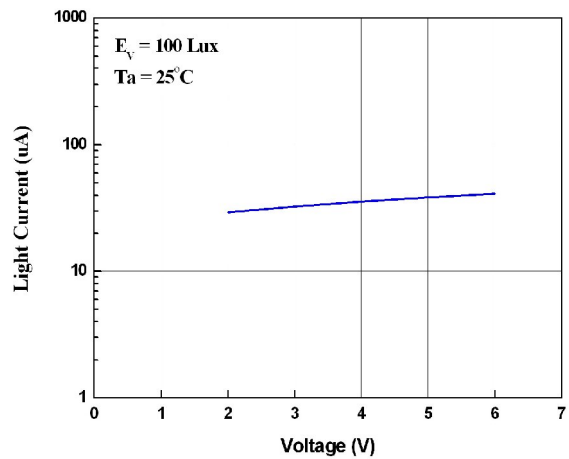

Fig.5 Light Current vs. Temperature

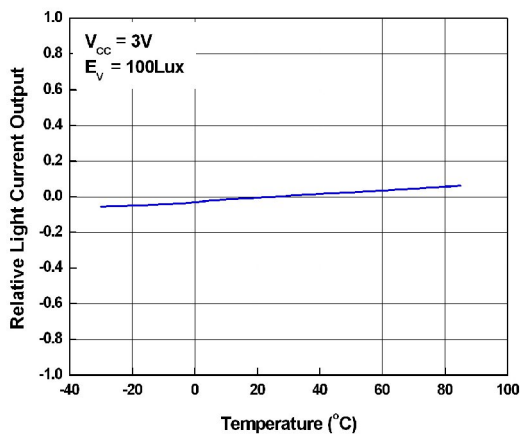
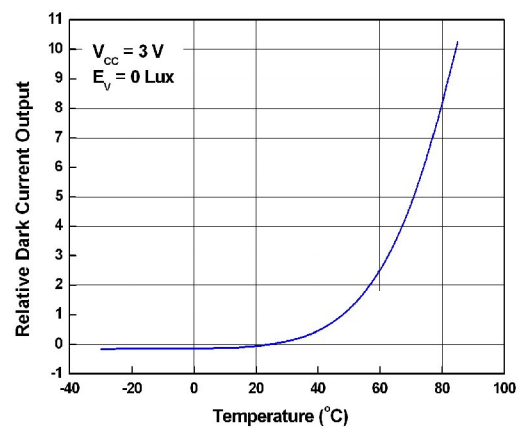
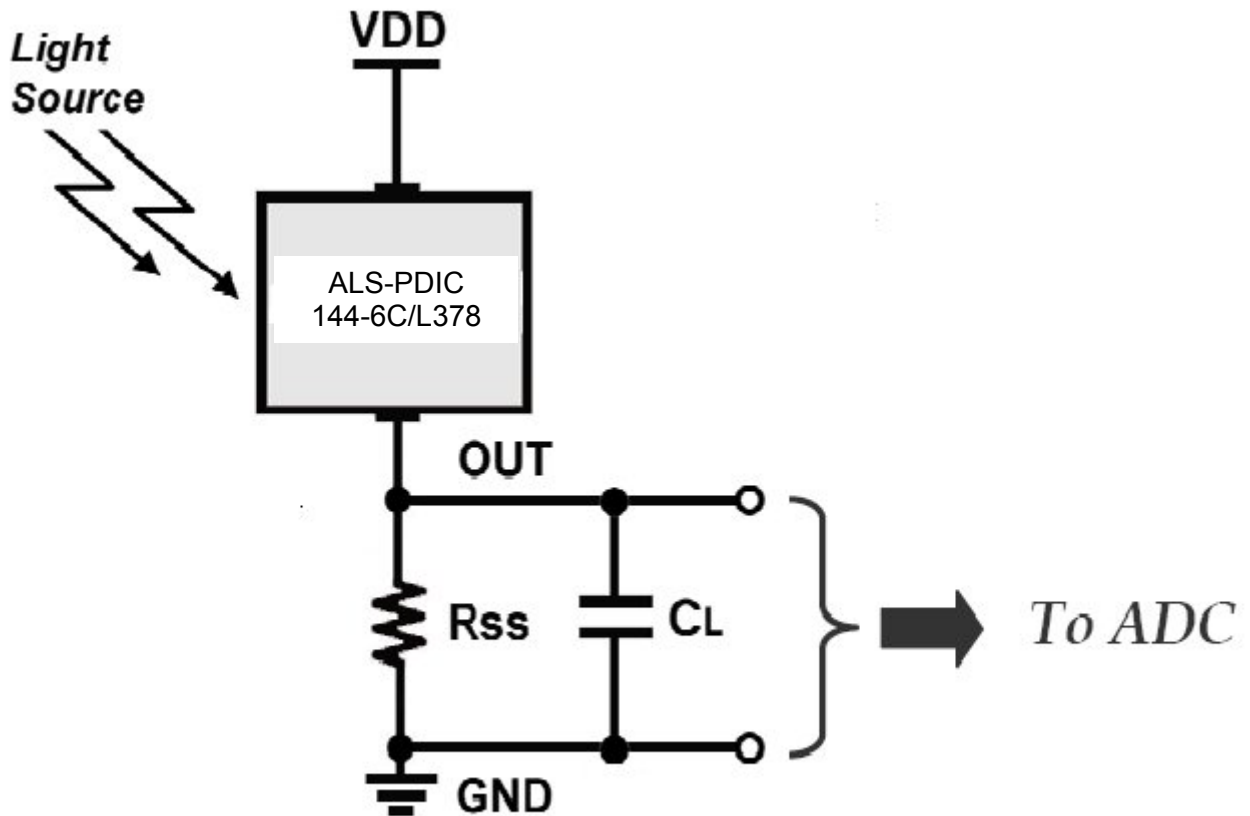

Fig.6 Dark Current vs. Temperature



Converting Photocurrent to Voltage



Note:

1. The output voltage (V_{out}) is the product of photocurrent (I_{PH}) and loading resistor (R_L)
2. A right loading resistor shall be chosen to meet the requirement of maximum ambient light, and output saturation voltage:

$$V_{out(max.)} = I_{out(max.)} \times R_L \quad V_{out(saturation)} = V_{cc} - 1.2V$$

Packing Quantity Specification

1.500PCS/1Bag , 5Bags/1Box
2.10Boxes/1Carton

Label Format

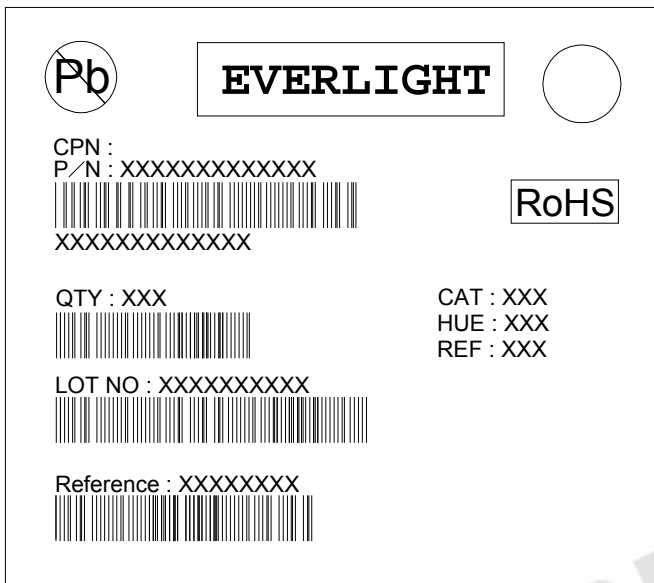

CPN: Customer's Production Number
P/N : Production Number
QTY: Packing Quantity
CAT: Ranks
HUE: Peak Wavelength
REF: Reference
LOT No: Lot Number
MADE IN TAIWAN: Production Place

Note

1. Above specification may be changed without notice. EVERLIGHT will reserve authority on material change for above specification.
2. When using this product, please observe the absolute maximum ratings and the instructions for using outlined in these specification sheets. EVERLIGHT assumes no responsibility for any damage resulting from use of the product which does not comply with the absolute maximum ratings and instructions included in these specification sheets.
3. These specification sheets include materials protected under copyright of EVERLIGHT Corporation. Please don't reproduce or cause anyone to reproduce them without EVERLIGHT's consent.