

Block mounting filter, for vertical flange-mounting

RE 51417/12.10
Replaces: 07.10

1/18

Type 450PBFN0040 to 1000; 450PBF0130, 0150

Size according to **DIN 24550**: 0040 to 1000
 Additional sizes: 0130, 0150
 Nominal pressure 450 bar [6530 psi]
 Connection up to DN 40
 Operating temperature -10 °C to 100 °C [14 °F to 212 °F]



Filter_75_d

Table of contents

Content	Page
Features	1
Ordering code	2
Standard types	3
Ordering code: electronic switching element for maintenance indicator	4
Mating connectors according to IEC 60947-5-2	4
Symbols	5
Function, section	6
Technical data	7, 8
Characteristic curves	9 ... 12
Unit dimensions	13, 14
Maintenance indicator	15
Spare parts	16
Installation, commissioning, maintenance	17
Quality and standardization	18

Features

- Special highly efficient filter media
- Adsorption of very fine particles across a broad pressure differential range
- High dirt holding capacity thanks to large specific filter area
- Good chemical resistance of the filter elements
- High collapse resistance of the filter elements (e.g. in case of cold start)
- Filter ratings of $3\text{ }\mu\text{m}$ to $100\text{ }\mu\text{m}$
- By default equipped with mechanical optical maintenance indicator with memory function
- Flow-optimized design due to 3D computer-supported design

Ordering code

of the filter

450	PBF		—		00	—V5,0—	
-----	-----	--	---	--	----	--------	--

Pressure

450 bar [6530 psi] = 450

Block mounting filter,

For vertical flange-mounting = PBF

Filter element

According to DIN 24550 = N

Size

PBFN... = 0040 0063 0100 0160
0250 0400 0630 1000

PBF... = 0130 0150

Filter rating in μm

nominal

Stainless steel wire mesh, cleanable

G10, G25, G40, G100 = G...

absolute (ISO 16889)

Micro glass, not cleanable

H3XL, H6XL, H10XL, H20XL = H...XL

Pressure differential

Max. admissible pressure differential of the filter element

30 bar [435 psi], with bypass valve 7 bar [102 psi] = A

330 bar [4786 psi], without bypass valve = B

Element design

Standard adhesive T = 100 °C [212 °F] = 0...

Standard material = ...0

Complementary details

without = No complementary details

—A1 = Connection nominal width 32
(size 0630 – 1000)

Seal

M = NBR seal

V = FKM seal

Maintenance indicator

V5,0 = Maintenance indicator, optical
specify switching pressure 5.0 bar [72.5 psi]

Order example:

450PBFN0063-H3XLB00-V5,0-M

Material no.: R928023332

Further versions (filter materials, connections,...) are available at request.

of the filter element

2.		—		—	0	—
----	--	---	--	---	---	---

Filter element

Design = 2.

Size

PSFN... = 0040 0063 0100 0160
0250 0400 0630 1000

PSF... = 0130 0150

Filter rating in μm

nominal

Stainless steel wire mesh, cleanable

G10, G25, G40, G100 = G...

absolute (ISO 16889)

Micro glass, not cleanable

H3XL, H6XL, H10XL, H20XL = H...XL

Pressure differential

Max. admissible pressure differential of the filter element

30 bar [435 psi], with bypass valve 7 bar [102 psi] = A

330 bar [4786 psi], without bypass valve = B

Seal

M = NBR seal

V = FKM seal

Bypass valve

0 = at filter element always 0

Element design

0... = Standard adhesive T = 100 °C [212 °F]

...0 = Standard material

Order example:

2.0063 H3XL-B00-0-M0

Material no.: R928006708

Standard types

NBR seal, without bypass, flow specifications for $v = 30 \text{ mm}^2/\text{s}$

Block mounting filter 450PFB(N), filter rating **3 μm**

Type	Flow in l/min [gpm] with $\Delta p = 1.5 \text{ bar}$ [21.8 psi] ¹⁾	Material no. Filter	Material no. Replacement element
450PBFN0040-H3XLB00-V5,0-M	28 [7.4 gpm]	R928023331	R928006654
450PBFN0063-H3XLB00-V5,0-M	37 [9.8 gpm]	R928023332	R928006708
450PBFN0100-H3XLB00-V5,0-M	42 [11.1 gpm]	R928023333	R928006762
450PBF0130-H3XLB00-V5,0-M	80 [21.1 gpm]	R928023334	R928022310
450PBF0150-H3XLB00-V5,0-M	94 [24.8 gpm]	R928023335	R928022319
450PBFN0160-H3XLB00-V5,0-M	160 [42.3 gpm]	R928023336	R928006816
450PBFN0250-H3XLB00-V5,0-M	225 [59.4 gpm]	R928023337	R928006870
450PBFN0400-H3XLB00-V5,0-M	260 [68.7 gpm]	R928023338	R928006924
450PBFN0630-H3XLB00-V5,0-M	350 [92.5 gpm]	R928023339	R928006978
450PBFN1000-H3XLB00-V5,0-M	380 [100.4 gpm]	R928023340	R928007032

Block mounting filter 450PFB(N), filter rating **6 μm**

Type	Flow in l/min [gpm] with $\Delta p = 1.5 \text{ bar}$ [21.8 psi] ¹⁾	Material no. Filter	Material no. Replacement element
450PBFN0040-H6XLB00-V5,0-M	38 [10.0 gpm]	R928023411	R928006655
450PBFN0063-H6XLB00-V5,0-M	43 [11.4 gpm]	R928023412	R928006709
450PBFN0100-H6XLB00-V5,0-M	48 [12.7 gpm]	R928023413	R928006763
450PBF0130-H6XLB00-V5,0-M	100 [26.4 gpm]	R928023414	R928022311
450PBF0150-H6XLB00-V5,0-M	115 [30.4 gpm]	R928023415	R928022320
450PBFN0160-H6XLB00-V5,0-M	210 [55.5 gpm]	R928023416	R928006817
450PBFN0250-H6XLB00-V5,0-M	250 [66.0 gpm]	R928023417	R928006871
450PBFN0400-H6XLB00-V5,0-M	270 [71.3 gpm]	R928023418	R928006925
450PBFN0630-H6XLB00-V5,0-M	380 [100.4 gpm]	R928023419	R928006979
450PBFN1000-H6XLB00-V5,0-M	420 [111.0 gpm]	R928023420	R928007033

Block mounting filter 450PFB(N), filter rating **10 μm**

Type	Flow in l/min [gpm] with $\Delta p = 1.5 \text{ bar}$ [21.8 psi] ¹⁾	Material no. Filter	Material no. Replacement element
450PBFN0040-H10XLB00-V5,0-M	43 [11.4 gpm]	R928023491	R928006656
450PBFN0063-H10XLB00-V5,0-M	48 [12.7 gpm]	R928023492	R928006710
450PBFN0100-H10XLB00-V5,0-M	52 [13.7 gpm]	R928023493	R928006764
450PBF0130-H10XLB00-V5,0-M	110 [29.1 gpm]	R928023494	R928022312
450PBF0150-H10XLB00-V5,0-M	125 [33.0 gpm]	R928023495	R928022321
450PBFN0160-H10XLB00-V5,0-M	240 [63.4 gpm]	R928023496	R928006818
450PBFN0250-H10XLB00-V5,0-M	260 [68.7 gpm]	R928023497	R928006872
450PBFN0400-H10XLB00-V5,0-M	280 [74.0 gpm]	R928023498	R928006926
450PBFN0630-H10XLB00-V5,0-M	400 [105.7 gpm]	R928023499	R928006980
450PBFN1000-H10XLB00-V5,0-M	450 [118.9 gpm]	R928023500	R928007034

¹⁾ Measured pressure differential across filter and measuring equipment according to ISO 3968. The measured pressure differential at the maintenance indicator is lower.

Ordering code: Electronic switching element for maintenance indicator

ABZ	F	V	-	-1X	/	-DIN
-----	---	---	---	-----	---	------

Rexroth plant construction accessories

Filter

Maintenance indicator

Electronic switching element with 1 switching point (changeover)
round plug-in connection M12x1**= E1SP-M12X1**Electronic switching element with 2 switching points (normally open/
normally closed), 75 %, 100 %, round plug-in
connection M12x1, 3 LED**= E2SP-M12X1**Electronic switching element with 2 switching points (normally open/
normally closed), 75 %, 100 %, signal suppression until 30 °C
round plug-in connection M12x1, 3 LED**= E2SPSU-M12X1****-DIN =**

Mark for DIN version

1X =**Component series**Component series 10 to 19
(10 to 19; identical installation
and connection dimensions)

Electronic switching element	Material no.
ABZFV-E1SP-M12X1-1X/-DIN	R901025339
ABZFV-E2SP-M12X1-1X/-DIN	R901025340
ABZFV-E2SPSU-M12X1-1X/-DIN	R901025341

Order example: Block mounting filter with mechanical optical maintenance indicator for $p_{nom.} = 450 \text{ bar}$ [6527 psi] without bypass valve, size 0063, with filter element $10 \mu\text{m}$ and electronic switching element M12x1 with 1 switching point for hydraulic fluid mineral oil HLP according to DIN 51524.

Filter: 450PBFN0063-H10XLB00-V5,0-M**Material number: R928023492****Maintenance indicator:** ABZFV-E1SP-M12X1-1X/-DIN**Material number: R901025339****Mating connectors according to IEC 60947-5-2 (dimensions in mm [inch])**

For electronic switching element with round plug-in connection M12 x 1

**Mating connector for K24 4-pin, M12 x 1
with screw connection, cable gland Pg9.**

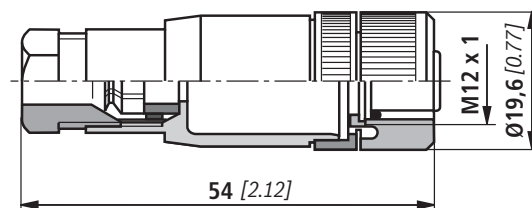
Material no. R900031155

**Mating connector for K24-3m 4-pin, M12 x 1
with potted-in PVC cable, 3 m long.**

Line diameter: 4 x 0.34 mm²

Core marking:

1	Brown
2	White
3	Blue
4	Black

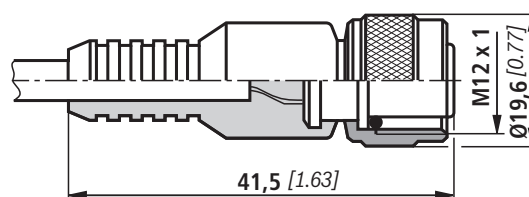
Material no. R900064381

For more round plug-in connections, see data sheet 08006.

Symbols

Block mounting filter

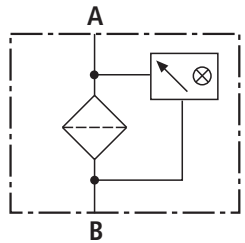
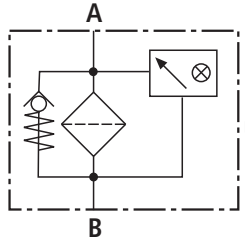

**Electronic switching element
for maintenance indicator**

Switching element Plug-in connector

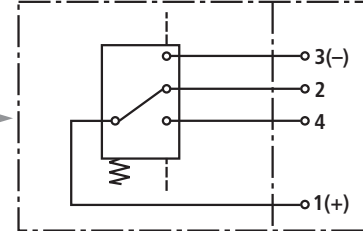

ABZFV-E1SP-M12X1-1X/-DIN

Switching element Plug-in connector

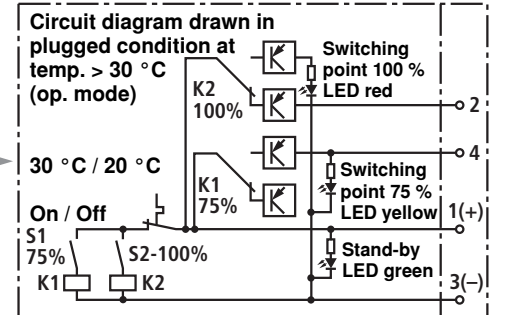

ABZFV-E2SPSU-M12X1-1X/-DIN

Switching element Plug-in connector

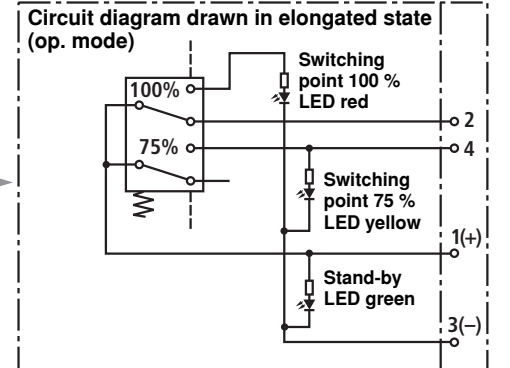

ABZFV-E2SP-M12X1-1X/-DIN

Function, section

Block mounting filters are suitable for direct attachment in pump blocks and manifolds. They are installed upstream control units or controllers to be protected.

They basically consist of filter head (1), a screwable filter bowl (2), filter element (3) as well as mechanical optical maintenance indicator (4). In case of filters with low-pressure-differential-stable filter elements (= code letter pressure differential A), there is also an assembled bypass valve (5).

Via port I, the hydraulic fluid reaches the filter element (3) where it is cleaned. The dirt particles filtered out settle in the filter bowl (2) and in the filter element (3). Via port 0, the filtered hydraulic fluid enters the hydraulic circuit.

The filter housing and all connection elements are designed so that pressure peaks - as they may e.g. occur in case of the abrupt opening of large control valves due to the accelerated fluid weight - can be securely absorbed. As of size 0160, the standard equipment comprises an oil drain plug (7). With size 1000, the filter bowl has a two-part design.

Basically, the filter is equipped with mechanical optical maintenance indicator (4). The electronic maintenance indicator is connected via the electronic switching element with 1 or 2 switching points (6), which has to be ordered separately. The electronic switching element is attached to the mechanical optical maintenance indicator and held by means of a locking ring.

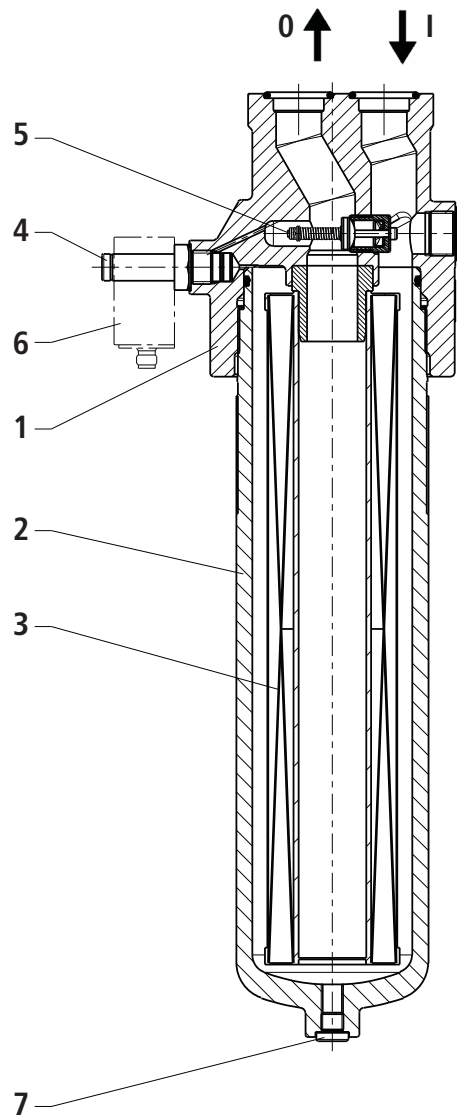

Technical data (For applications outside these parameters, please consult us!)**general**

Installation position	Vertical					
Ambient temperature range	°C [°F]	-30 to +100 [-22 to +212]				
Weight	Size	0040	0063	0100	0130	0150
	kg [lbs]	5 [11]	5.5 [12.1]	6.4 [14.1]	11.9 [26.2]	12.9 [28.4]
Weight	Size	0160	0250	0400	0630	1000
	kg [lbs]	15.9 [35.1]	16.5 [36.3]	19.9 [43.8]	37.5 [82.5]	48 [106]
Material	Filter head	GGG				
	Filter bowl	Steel				
	Optical maintenance indicator	Brass				
	Electronic switching element	Plastic PA6				

hydraulic

Maximum operating pressure	bar [psi]	450 [6530]
Hydraulic fluid temperature range	°C [°F]	-10 to +100 [+14 to +212] (shortly -30 [-22])
Fatigue strength according to ISO 10771	Load cycles	> 10 ⁶ with max. operating pressure
Cracking pressure of the bypass valve	bar [psi]	7 ± 0.5 [100 ± 7]
Type of pressure measurement of the maintenance indicator	Differential pressure	
Response pressure of the maintenance indicator	bar [psi]	5 ± 0.5 [72 ± 7]

electrical (electronic switching element)

Electrical connection	Round plug-in connection M12 x 1, 4-pin	
Contact load, direct voltage	A	max. 1
Voltage range	E1SP-M12x1 V DC/AC	max. 150
	E2SP V DC	10 to 30
Max. switching power with resistive load	20 VA; 20 W; (70 VA)	
Switching type	E1SP-M12x1	Changeover
	E2SP-M12x1	Normally open contact at 75 % of the response pressure, normally closed contact at 100 % of the response pressure
	E2SPSU-M12x1	Normally open contact at 75 % of the response pressure, normally closed contact at 100 % of the response pressure Signal interconnection at 30 °C [86 °F], return switching at 20 °C [68 °F]
Display via LEDs in the electronic switching element E2SP...	Stand-by (LED green); 75 % switching point (LED yellow); 100 % switching point (LED red)	
Protection class according to EN 60529	IP 65	

For direct voltage above 24 V, a spark extinguishing is to be planned to protect the switching contacts.

Weight	Electronic switching element: – with round plug-in connection M12 x 1	kg [lbs]	0.1 [0.22]
--------	--	----------	------------

Technical data (For applications outside these parameters, please consult us!)**Filter element**

Glass fiber paper H..XL			Single-use element on the basis of inorganic fiber
			Filtration ratio according to ISO 16889 up to $\Delta p = 5 \text{ bar [72.5 psi]}$
			Achievable oil cleanliness according to ISO 4406 [SAE-AS 4059]
	H20XL		$\beta_{20}(c) \geq 200$
	H10XL		$\beta_{10}(c) \geq 200$
	H6XL		$\beta_6(c) \geq 200$
	H3XL		$\beta_5(c) \geq 200$
Admissible pressure differential	A	bar [psi]	30 [435]
	B	bar [psi]	330 [4786]

Seal material for hydraulic fluids

Mineral oil			Ordering code
Mineral oil	HLP	according to DIN 51524	M
Flame-resistant hydraulic fluids			Ordering code
Emulsions	HFA-E	according to DIN 24320	M
Synthetic water solutions	HFA-S	according to DIN 24320	M
Water solutions	HFC	according to VDMA 24317	M
Phosphoric acid esters	HFD-R	according to VDMA 24317	V
Organic esters	HFD-U	according to VDMA 24317	V
Fast biodegradable hydraulic fluids			Ordering code
Triglycerides (rape seed oil)	HETG	according to VDMA 24568	M
Synthetic esters	HEES	according to VDMA 24568	V
Polyglycols	HEPG	according to VDMA 24568	V

Characteristic curves (measured with HLP46, according to ISO 3968)

H3XL...

Specific weight: < 0.9 kg/dm³

Δp -Q characteristic curves for complete filters
recommended initial Δp for design = 1.5 bar

A proper filter design is enabled by our computer program
"BRFilterSelect".

Oil viscosity:
 — 140 mm²/s [649 SUS]
 - · - 68 mm²/s [315 SUS]
 - - - 30 mm²/s [142 SUS]

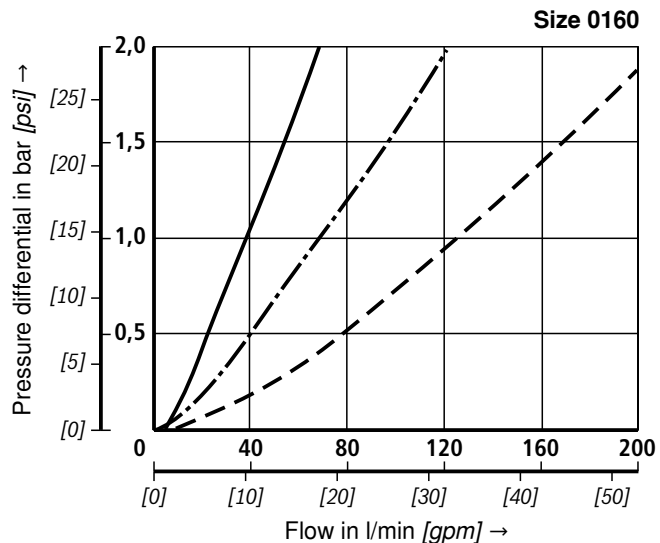
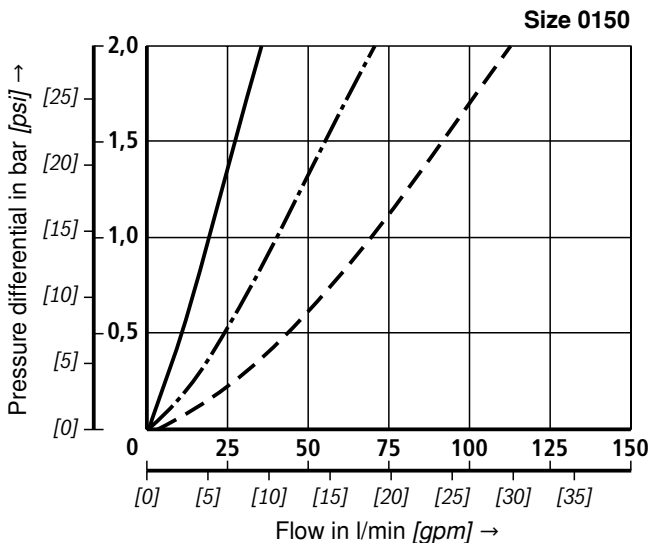
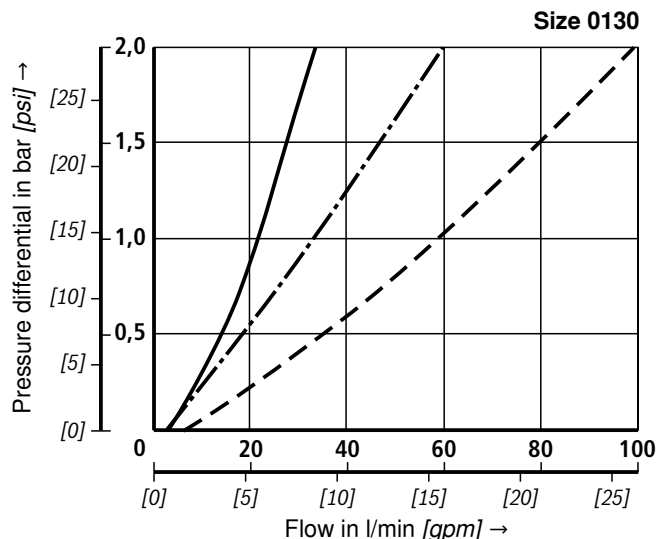
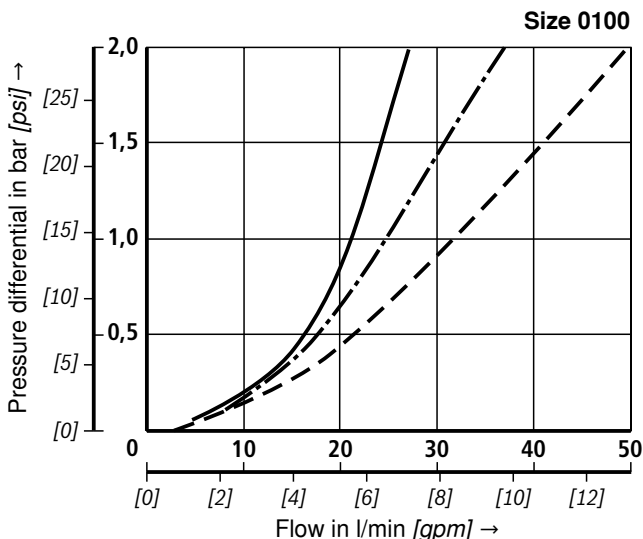
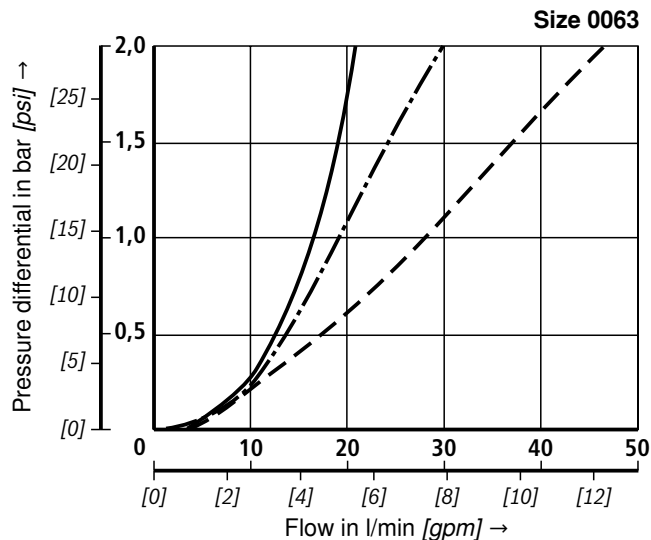
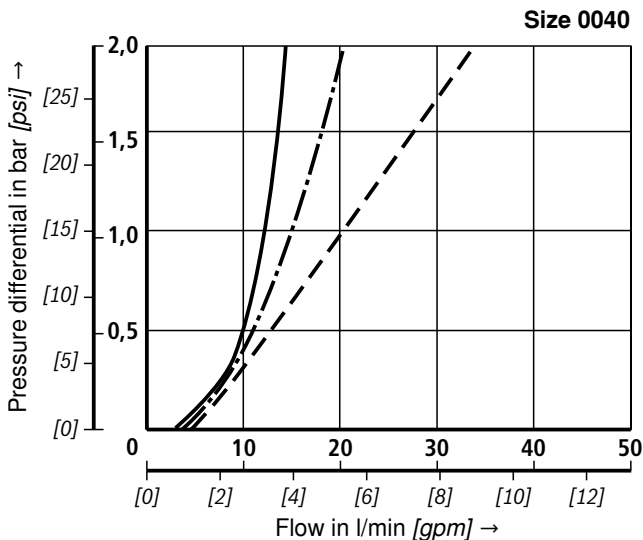

Characteristic curves (measured with HLP46, according to ISO 3968)

H3XL...

Specific weight: < 0.9 kg/dm³

Δp -Q characteristic curves for complete filters

recommended initial Δp for design = 1.5 bar

A proper filter design is enabled by our computer program "BRFilterSelect".

- 140 mm²/s [649 SUS]
- · - 68 mm²/s [315 SUS]
- - - 30 mm²/s [142 SUS]

Oil viscosity:

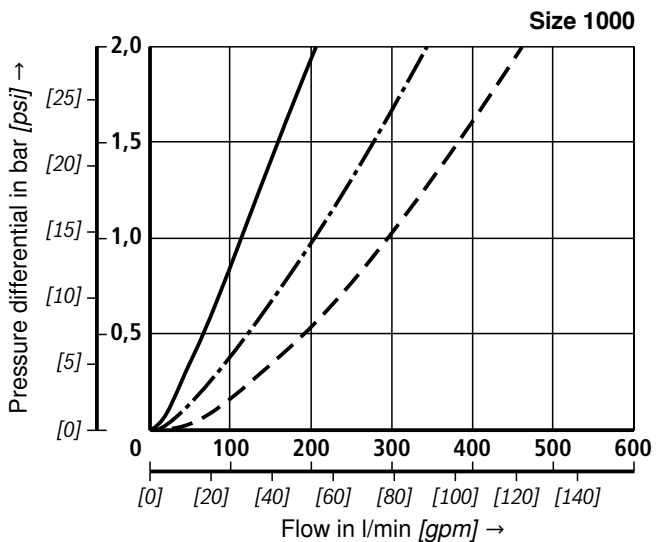
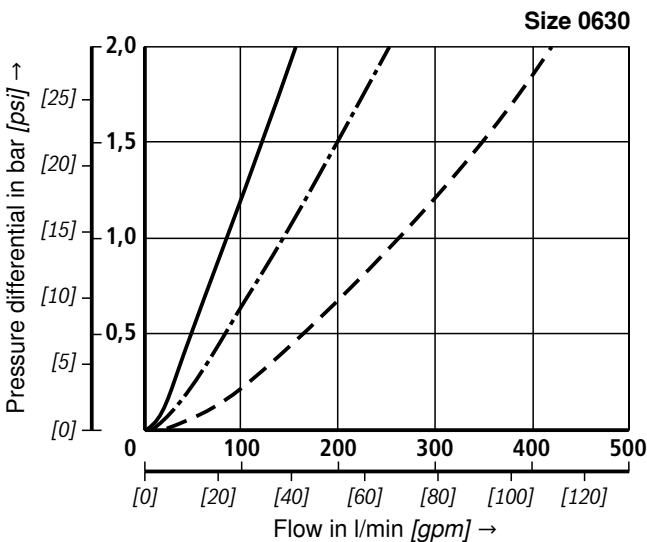
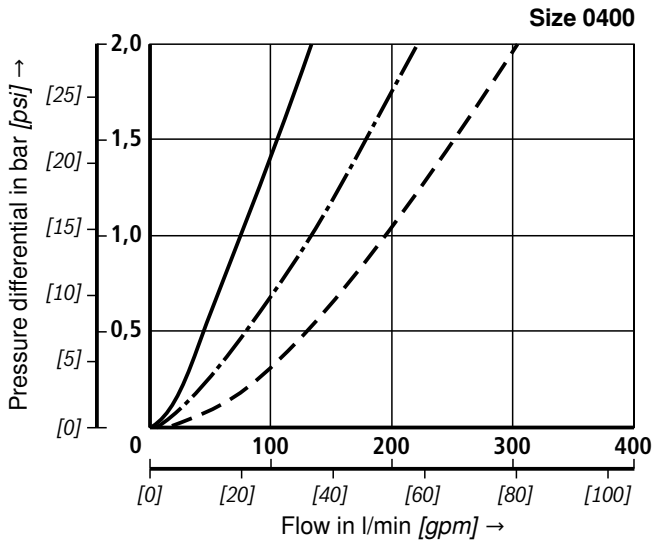
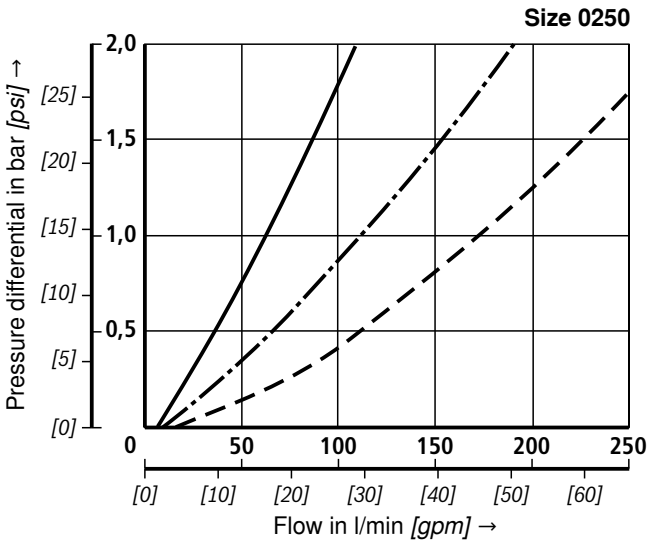

Characteristic curves (measured with HLP46, according to ISO 3968)

H10XL...

Specific weight: < 0.9 kg/dm³
 Δp -Q characteristic curves for complete filters
 recommended initial Δp for design = 1.5 bar

A proper filter design is enabled by our computer program
 "BRFilterSelect".

Oil viscosity:
 — 140 mm²/s [649 SUS]
 - · - 68 mm²/s [315 SUS]
 - - - 30 mm²/s [142 SUS]

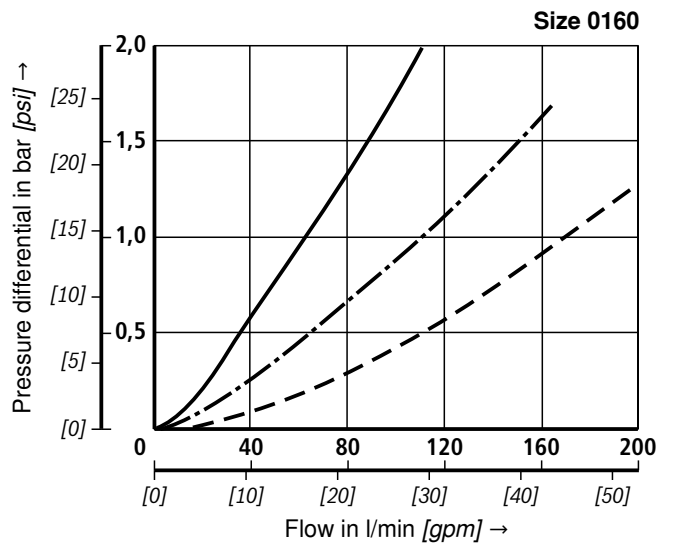
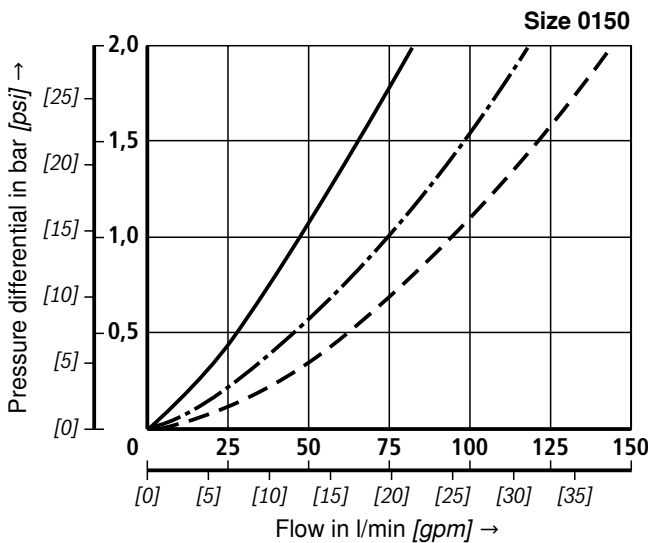
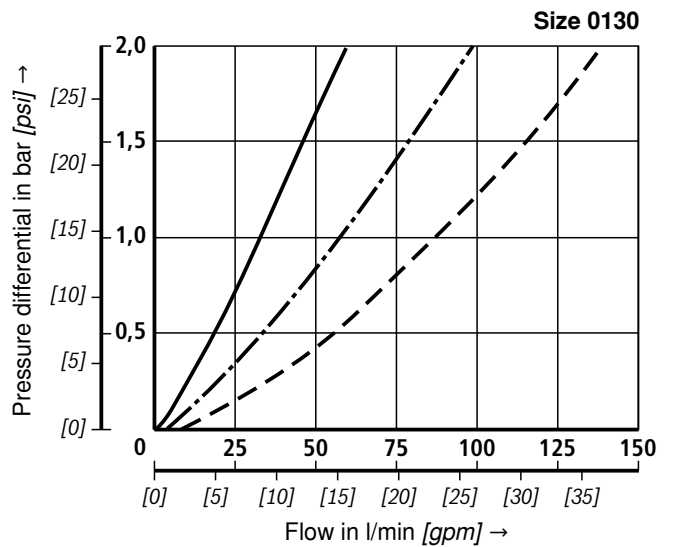
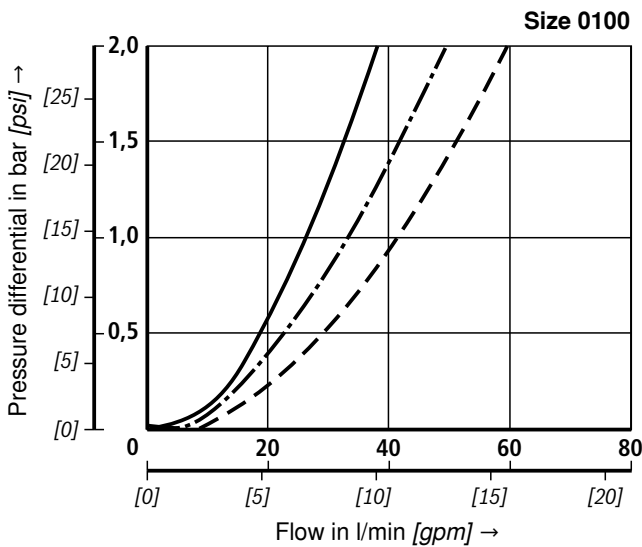
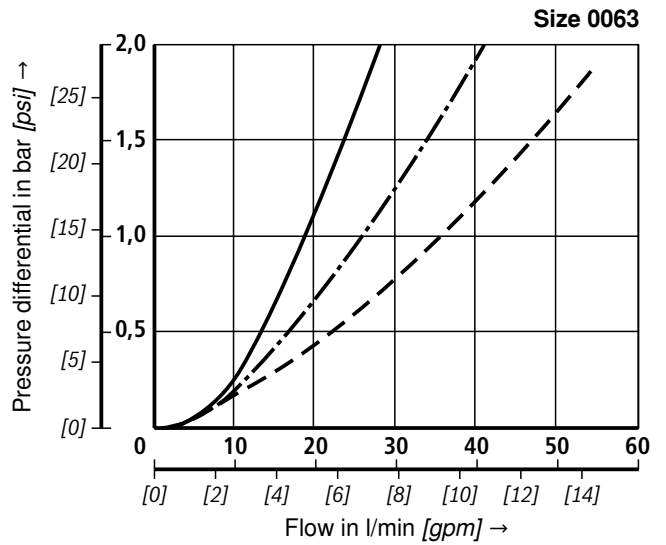
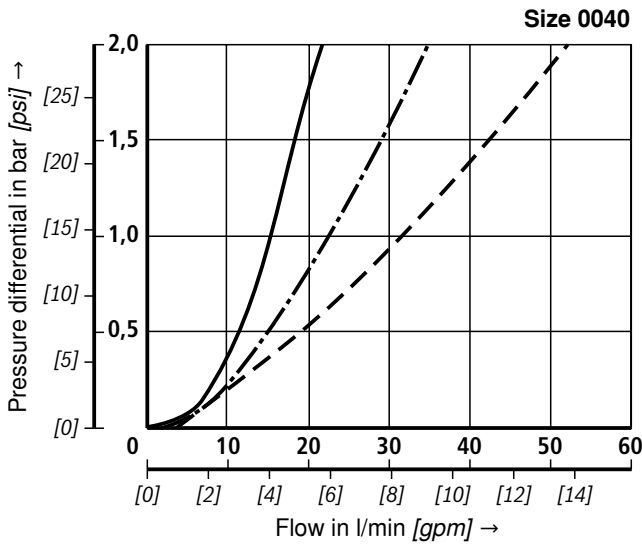

Characteristic curves (measured with HLP46, according to ISO 3968)

H10XL...

Specific weight: < 0.9 kg/dm³

Δp -Q characteristic curves for complete filters

recommended initial Δp for design = 1.5 bar

A proper filter design is enabled by our computer program "BRFilterSelect".

- 140 mm²/s [649 SUS]
- · - 68 mm²/s [315 SUS]
- - - 30 mm²/s [142 SUS]

Oil viscosity:

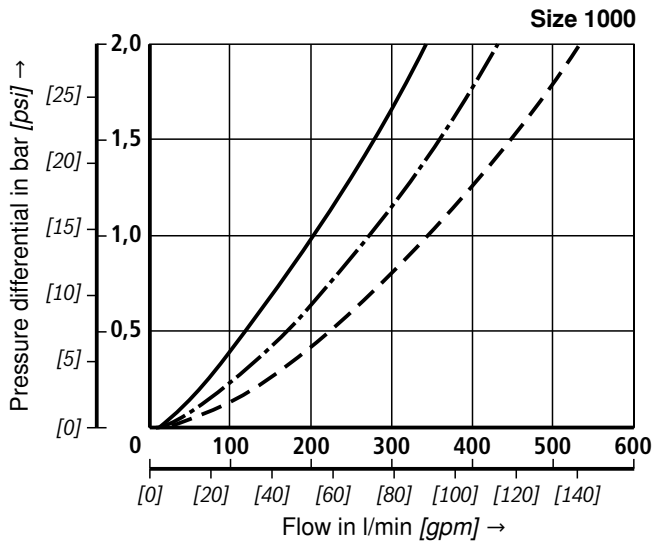
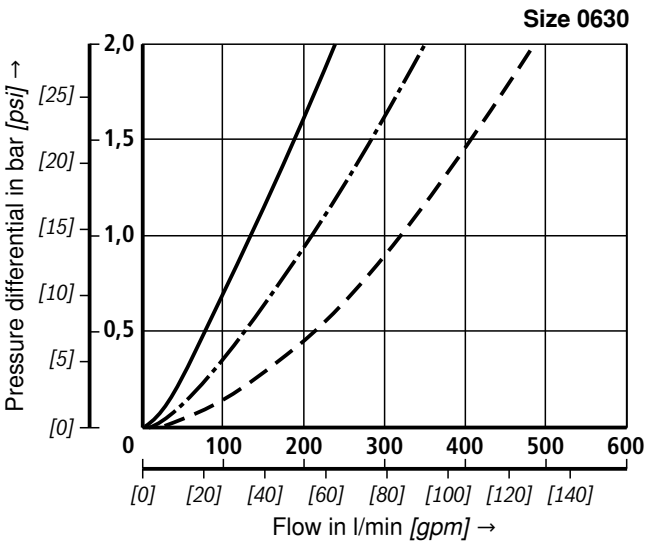
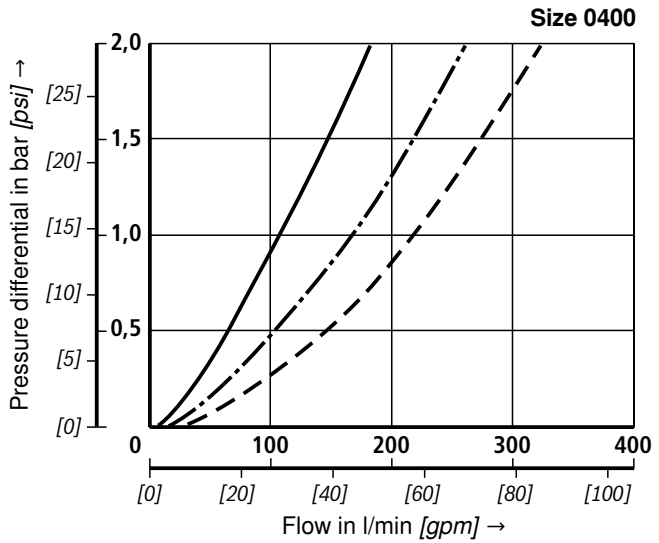
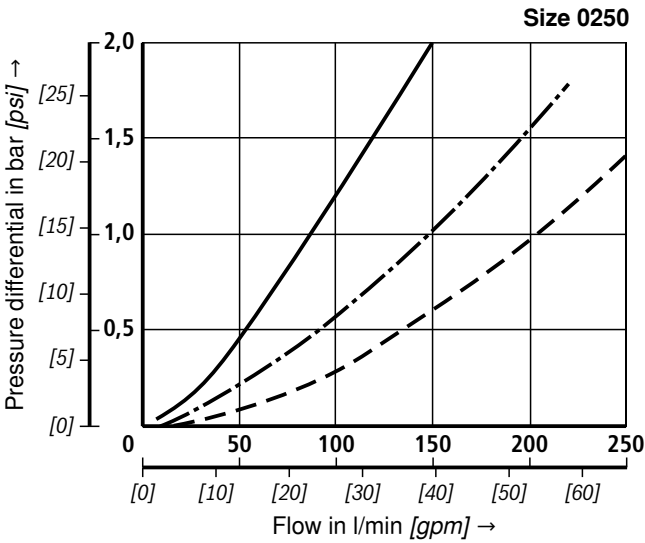

Unit dimensions size 0040 to size 0150 (dimensions in mm [inch])

Size 0040 to 0100

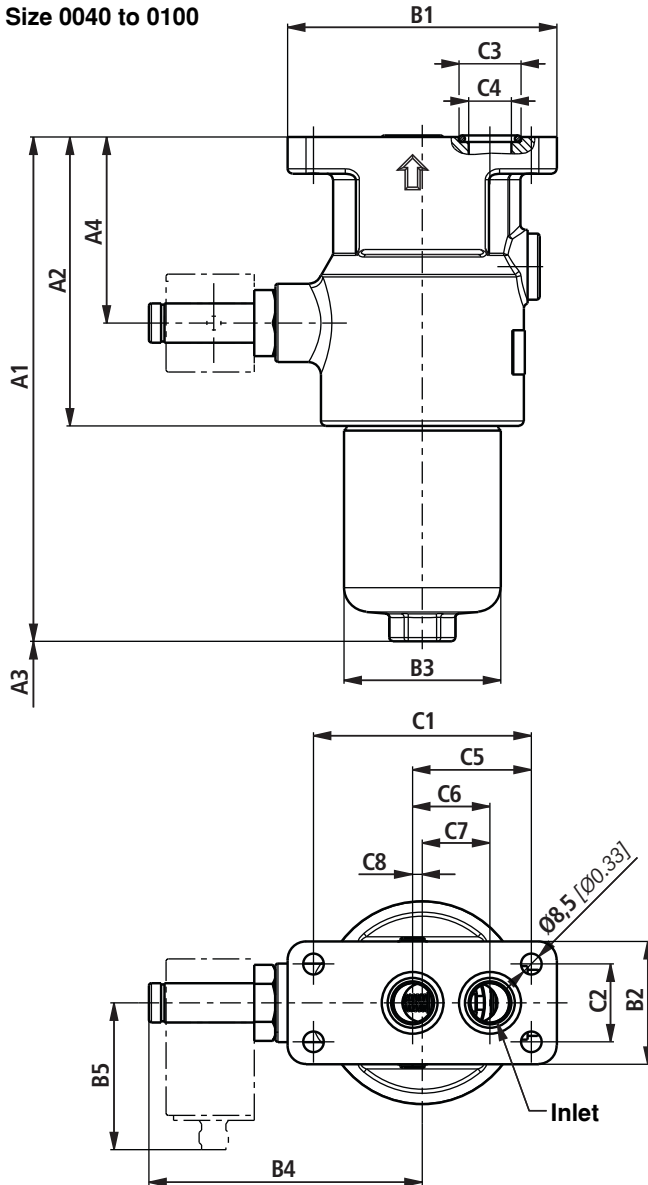

Size 0130 to 0150

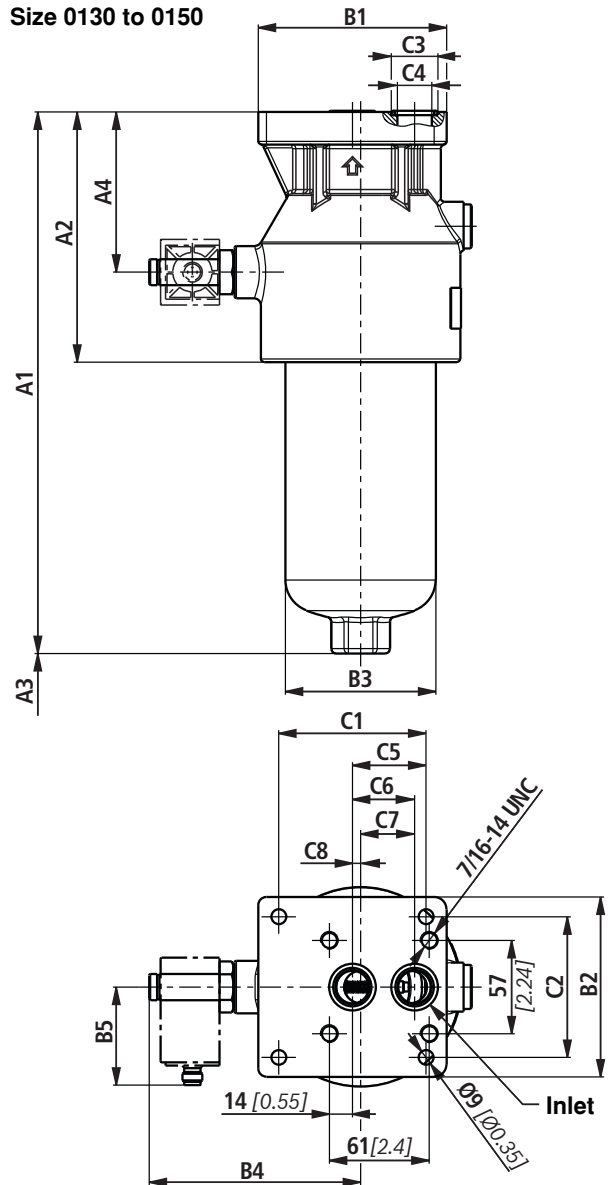

Type 450 PBF(N)...	Content in l [US gal]	A1	A2	A3 ¹⁾	A4	B1	B2	B3 Ø	B4
0040	0.25 [0.06]	206 [8.11]	118 [4.65]	100 [3.94]	76 [2.99]	110 [4.33]	50 [1.97]	64 [2.52]	112 [4.41]
0063	0.36 [0.09]	270 [10.6]							
0100	0.55 [0.14]	360 [14.2]							
0130	0.95 [0.25]	331 [13.0]	153 [6.03]	120 [4.72]	98 [3.86]	115 [4.53]	110 [4.33]	92 [3.62]	129 [5.08]
0150	1.15 [0.30]	382 [15.0]							

Type 450 PBF(N)...	B5	C1	C2	C3 Ø	C4 Ø	C5	C6	C7	C8
0040	60 [2.36]	89 [3.50]	31.8 [1.25]	25.3 [0.99]	17.5 [0.69]	48.5 [1.91]	31.6 [1.24]	27.6 [1.09]	4 [0.16]
0063									
0100									
0130		90 [3.54]	86 [3.39]	28.6 [1.13]	21 [0.83]	45 [1.77]	38 [1.50]	33 [1.30]	5 [0.20]
0150									

¹⁾ Servicing height for filter replacement

Unit dimensions size 0160 to size 1000 (dimensions in mm [inch])

Size 0160 to 0400

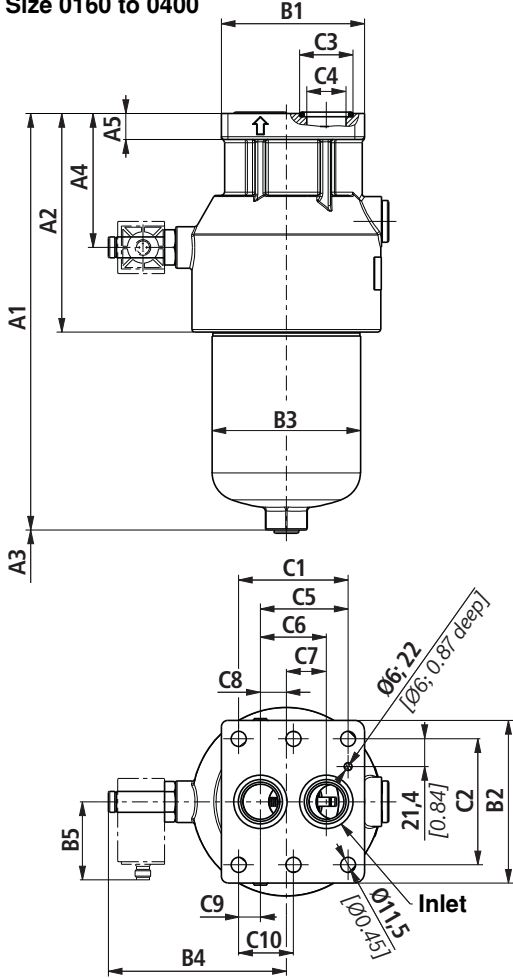

Size 0630 to 1000

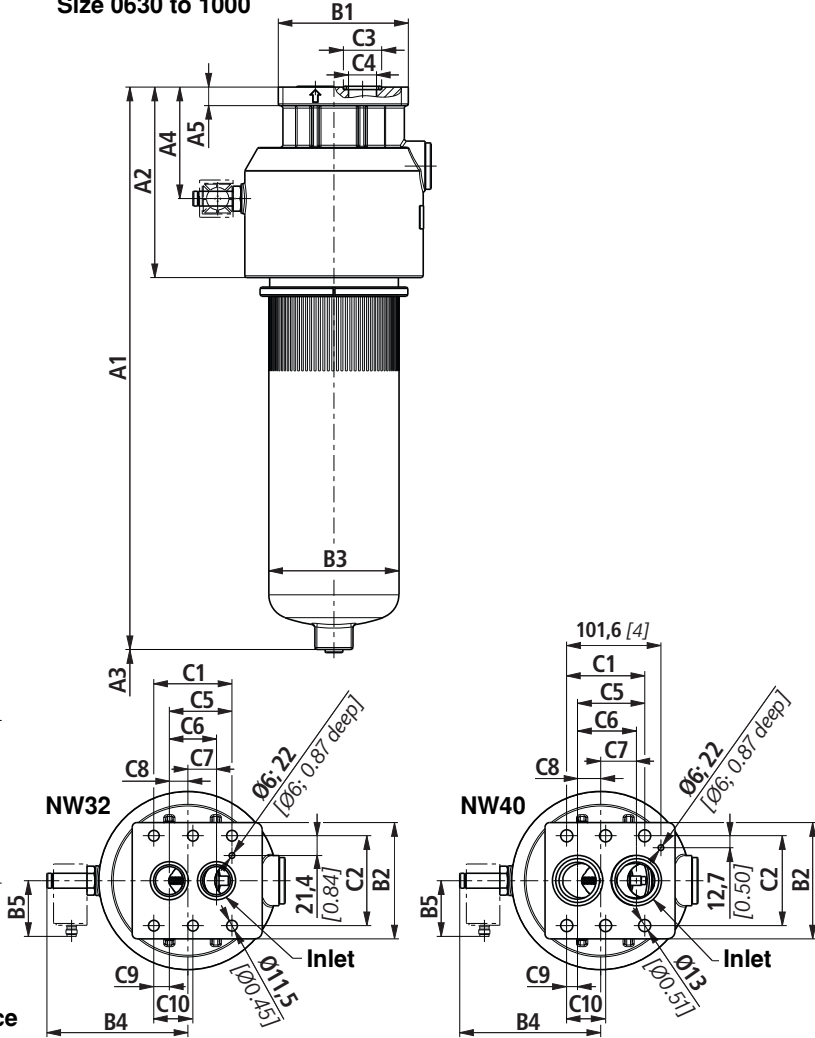

Filter housing for filter elements in accordance with DIN 24550 and according to BR standard

Type 450 PBF(N)...	Content in l [US gal]	A1	A2	A3 ¹⁾	A4	A5	B1	B2	B3	B4	B5
0160	1.6 [0.42]	320 [12.6]	168 [6.61]	120 [4.72]	103 [4.06]	22 [0.87]	110 [4.33]	125 [4.92]	114 [4.49]	137 [5.39]	60 [2.36]
0250	2.2 [0.58]	410 [16.1]									
0400	3.5 [0.92]	560 [22.05]									
0630	5.0 [1.32]	605 [23.82]	205 [8.07]	160 [6.30]	120 [4.72]	140 [5.51]	125 [4.92]	140 [5.51]	140 [5.51]	152 [5.98]	60 [2.36]
1000	6.5 [1.72]	843 [33.20]		650 [25.6]					190 [7.48]		
A1 0630	5.0 [1.32]	605 [23.82]		160 [6.30]					140 [5.51]		
A1 1000	6.5 [1.72]	843 [33.20]		650 [25.6]					190 [7.48]		

Type 450 PBF(N)...	C1	C2	C3 Ø	C4 Ø	C5	C6	C7	C8	C9	C10
0160	84.1 [3.31]	96.8 [3.81]	41 [1.61]	30 [1.18]	67.4 [2.65]	50.7 [1.99]	30.7 [1.21]	20 [0.79]	16.7 [0.66]	42.05 [1.66]
0250			54.3 [2.14]	40 [1.57]	72.4 [2.85]	63.5 [2.50]	38.5 [1.52]	25 [0.98]	11.7 [0.46]	
0400										
0630										
1000	41 [1.61]	30 [1.18]	67.4 [2.65]	50.7 [1.99]	30.7 [1.21]	20 [0.79]	16.7 [0.66]			
A1 0630										
A1 1000										

¹⁾ Servicing height for filter replacement

Maintenance indicator (dimensions in mm)

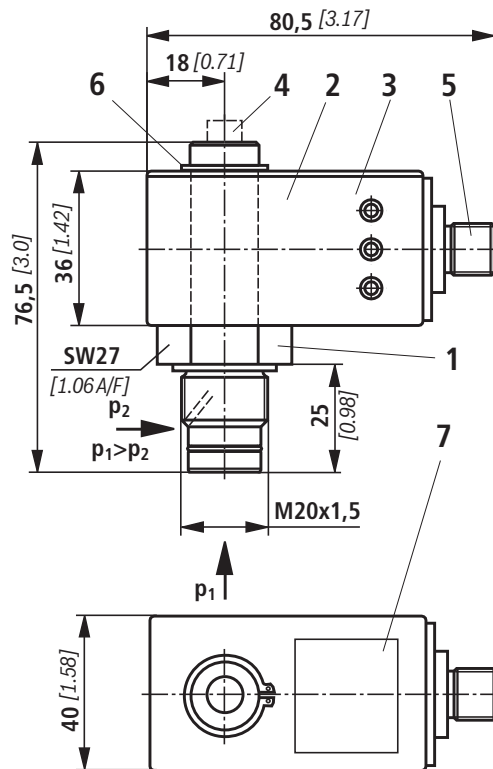

- 1 Mechanical optical maintenance indicator; max. tightening torque $M_{A \max} = 50 \text{ Nm}$ [36.88 lb-ft]
- 2 Switching element with locking ring for electrical maintenance indicator (can be rotated by 360°); Plug-in connection M12x1 or according to DIN EN 175201-804
- 3 Housing with three LEDs: 24 V =
Green: Stand-by
Yellow: Switching point 75 %
Red: Switching point 100 %
- 4 Optical indicator bistable
- 5 Round connector M12x1, 4-pin
- 6 Locking ring
- 7 Name plate

Notes:

Presentation contains mechanical optical maintenance indicator (1) and electronic switching element (2).

Round plug-in connection M12x1 (5)

For connection e.g. to ABZFV-E1SP-M12x1-1X/-DIN (see page 17).

Switching elements with increased switching power at request.

Spare parts

Mechanical optical maintenance indicator

ABZ F V HV5-1X / -DIN

Rexroth plant construction accessories

Filter

Maintenance indicator

Mechanical optical maintenance indicator for high-pressure filters switching point 5 bar [72 psi]

= HV5

DIN = Mark for DIN and SAE version

M =

V =

Seal material

NBR seal

FKM seal

Component series

Component series 10 to 19 (10 to 19; identical installation and connection dimensions)

1X =

Mechanical optical maintenance indicator	Material no.
ABZFV-HV5-1X/M-DIN	R901025313

Seal kit

D 450PBF

Seal kit

Type 450PBF

Size

Size 0040-0100

= N0040-0100

Size 0130-0150

= 0130-0150

Size 0160-0400

= N0160-0400

Size 0630

= N0630

Size 1000

= N1000

Size 0630, port A1

= N0630-A1

Size 1000, port A1

= N1000-A1

M =

V =

Seal

NBR seal

FKM seal

Seal kit	Material no.
SEAL KIT D450PBFN0040-0100-M	R961005214
SEAL KIT D450PBF0130-0150-M	R961005212
SEAL KIT D450PBFN0160-0400-M	R961005216
SEAL KIT D450PBFN0630-M	R961005218
SEAL KIT D450PBFN1000-M	R961005220

Installation, commissioning and maintenance

Installation of the filter

Verify operating pressure with name plate information. Remove blanking plugs from filter inlet and outlet, mount filter at the manifold without tension stress considering flow direction (direction arrows) and servicing height of the filter element. The filter must preferably be installed with the filter bowl (2) downward. The maintenance indicator must be arranged in a well visible way.

Connection of the electrical maintenance indicator

Basically, the filter is equipped with mechanical optical maintenance indicator (4). The electronic maintenance indicator is connected via the switching element (6) with 1 or 2 switching points, which is attached to the mechanical optical maintenance indicator and held by means of the locking ring.

When must the filter element be exchanged or cleaned respectively?

Upon start-up in cold condition, the red pushbutton of the optical maintenance indicator (4) may jump out and an electrical signal is output via the switching element (6). Only push the red pushbutton in again after the operating temperature has been reached. If it jumps out again immediately or if the electrical signal has not gone out at operating temperature, the filter element must be exchanged or cleaned respectively after the end of the shift.

Element exchange

- Switch off the system and discharge the filter on the pressure side.
- Screw off the filter bowl (2) or the floor (size 1000) by anticlockwise rotation. Clean the filter housing in a suitable medium.
- Remove the filter element (3) from the centering spigot in the filter head by turning it slightly
- Check the seal ring and the support ring in the filter bowl for position and damage. If necessary, these parts are to be renewed.
- Replace filter elements H...XL, clean the filter element with material G...
- The efficiency of the cleaning process depends on the characteristics of contamination and the final pressure drop prior to servicing / cleaning the filter element. If the pressure differential after the filter element exchange exceeds 50 % of the value before the filter element exchange, the G... element also needs to be replaced.
- Check whether the type designation or material number on the replacement element corresponds to the type designation/material number on the name plate of the filter.
- Install replaced or cleaned filter element on the spigot again by slightly turning it.
- Now screw in the filter bowl or floor to stop. Then turn out the filter bowl by 1/8 to 1/2 turn so that the filter bowl is not stuck due to the pressure pulsation and can be easily loosened in case of maintenance works.

Quality and standardization

The block mounting filters for hydraulic applications according to 51417 are pressure holding equipment according to article 1, section 2.1.4 of the pressure equipment directive 97/23/EC (PED). However, on the basis of the exception in article 1, section 3.6 of the PED, hydraulic filters are exempt from the PED if they are not classified higher than category I (guideline 1/19). They do not receive a CE mark.

Use in explosive areas according to directive 94/9/EC (ATEX)

The block mounting filters according to 51417 are no equipment or components in the sense of directive 94/9/EC and are not provided with a CE mark.

When using the block mounting filters according to 51417 in explosive areas, potential equalization has to be ensured.

According to DIN EN 50020, the electrical maintenance indicators are simple, electrical operating equipment not having own voltage sources. This simple, electrical operating equipment may - according to DIN EN 60079-14 - in intrinsically safe electrical circuits (EEx ib) be used in systems for device group II, category 2G (zone 1) and category 3G (zone 2) without marking and certification. The operating equipment is assigned to explosion group II B and temperature class T5.

Possible circuit according to DIN EN 60079-14

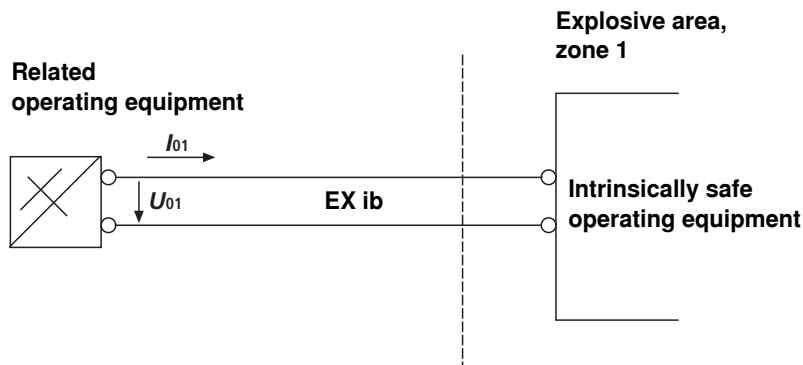

With electrical maintenance indicators with two switching points, switching units with two intrinsically safe input circles must be used.