

Tantalum Product - TPS Automotive Low ESR

RoHS COMPLIANT*



PRODUCT SPECIFICATIONS :

Nominal Capacitance @ 120Hz	47 μ F	
Capacitance Tolerance (*)	K = \pm 10%; M = \pm 20%	
Rated Voltage DC (V_R)	\leq 85°C	35 V
Category Voltage DC (V_C)	\leq 125°C	23 V
Surge Voltage (V_S)	\leq 85°C	46 V
	\leq 125°C	28 V
Temperature Range	-55°C to +125°C	
Direct Leakage Current max. @ V_R	16.5 μ A	
Dissipation Factor max. @ 120Hz	6 %	
ESR max. @ 100kHz	0.2 Ohm	
Typical weight (case)	512 mg	



LEAD-FREE
LEAD-FREE COMPATIBLE
COMPONENT

Moisture sensitivity level: meets MSL 3

Reflow specification: meets J-STD-020 standard

Meets requirements of AEC-Q200

100% surge current tested

All technical data relates to an ambient temperature of +25°C, Capacitance and DF are measured at 120Hz, 0.5RMS with DC bias of 2.2V.

DCL is measured at rated voltage after 5 minutes

The EIA and CECC standards for low ESR solid Tantalum capacitors allow an ESR movement to 1.25 times catalogue limit post mounting

AVX reserves the rights to supply higher voltage rating in the same case size, to the same reliability standards

RMS value of Ripple Current (mA) @100kHz			RMS value of Ripple Voltage (mV) @100kHz		
25°C	85°C	125°C	25°C	85°C	125°C
908	817	363	182	163	73

HOW TO ORDER:

TPS	E	476	*	035	#	0200	V
Type	Case code	Capacitance Value	Cap. Tolerance	Rated DC	Packaging Automotive Pure Tin T = 7" Reel U = 13" Reel	ESR in mOhms	Vacuum packing

DRAWING AND DIMENSIONS:

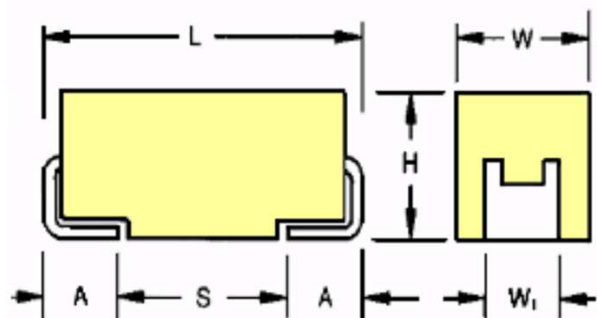
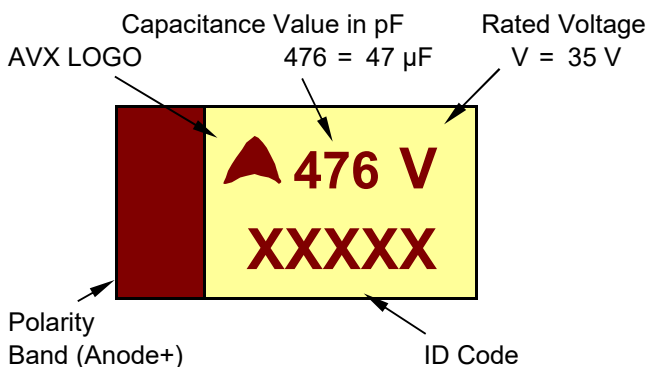

Tantalum Product - TPS Low ESR Series



CASE DIMENSIONS: millimetres

Case		L ±0.2	W +0.2 –0.1	H +0.2 –0.1	A +0.3 –0.2	S min.	W1 ±0.2
EIA	AVX						
7343-43	E	7.3	4.3	4.1	1.3	4.4	2.4

PACKAGING INFORMATION:

Reel Size (#)	T = 7" Reel Automotive Pure Tin	U = 13" Reel Automotive Pure Tin
Quantity	400	1500
Tape Width	12 mm	12 mm

AMERICAS

AVX Greenville, SC
Tel: 864-967-2150

EUROPE

AVX Limited, England
Tel: +44-1252-770000

AVX S.A.S. , France
Tel: +33-1-69-18-46-00

AVX GmbH, Germany
Tel: +49-0811-95949-0

AVX SRL, Italy
Tel: +39-02-614-571

AVX Czech Republic
Tel: +420-57-57-57-521

AVX/ELCO UK
Tel: +44-1638-675000

ELCO Europe GmbH
Tel: +49-2741-299-0

AVX S.A., Spain
Tel: +34-91-63-97-197

AVX Benelux
Tel: +31-187-489-337

ASIA-PACIFIC

AVX/Kyocera (S) Pte Ltd, Singapore
Tel: +65-6286-7555

AVX/Kyocera, Asia Ltd., Hong Kong
Tel: +852-2363-3303

AVX/Kyocera Yuhan Hoesa, South Korea
Tel: +82-2785-6504

AVX/Kyocera HK Ltd., Taiwan
Tel: +886-2-2656-0258

AVX/Kyocera (M) Sdn Bhd, Malaysia
Tel: +60-4228-1190

AVX/Kyocera International Trading
Co. Ltd., Shanghai
Tel: +86-21-3255-1933

AVX/Kyocera Asia Ltd., Shenzhen
Tel: +86-755-3336-0615

AVX/Kyocera International Trading Co. Ltd.,
Beijing
Tel: +86-10-6588-3528

AVX/Kyocera India Liaison Office
Tel: +91-80-6450-0715

ASIA-KED

(KYOCERA Electronic Devices)

KED Hong Kong Ltd.
Tel: +852-2305-1080/1223

KED Hong Kong Ltd., Shenzhen
Tel: +86-755-3398-9600

KED Company Ltd., Shanghai
Tel: +86-21-3255-1833

KED Hong Kong Ltd., Beijing
Tel: +86-10-5869-4655

KED Taiwan Ltd.
Tel: +886-2-2950-0268

KED Korea Yuhan Hoesa, South Korea
Tel: +82-2-783-3604/ 6126

KED (S) Pte Ltd., Singapore
Tel: +65-6509-0328

Kyocera Corporation, Japan
Tel: +81-75-604-3449

Issued by: AVX Technical Marketing Team
Tantalum Division
Technical assistance: Tech-info@avx.com
More details at: www.avx.com

Version: 11/2018

NOTICE: Specifications are subject to change without notice. Contact your nearest AVX Sales Office for the latest specifications. Specifications are typical and may not apply to all applications. All statements, information and data given herein are believed to be accurate and reliable, but are presented without guarantee, warranty, or responsibility of any kind, expressed or implied. Statements or suggestions concerning possible use of our product are made without responsibility or warranty that any such use is free of patent infringement and are not recommendations to infringe any patent. The user should not assume that all safety measures are indicated or that other measures are indicated or that measures may not be required. All samples are provided for testing purposes only. Provision of samples shall not constitute any offer of sale nor shall it constitute any commitment of any kind. Samples may not be incorporated in any product offered for commercial sale. Recipient assumes all risks and liability resulting from such testing. Samples are for the exclusive use of the direct recipient and shall not be sold, lent, given, or otherwise transferred to any other party. All unused samples shall be destroyed or returned to AVX.