

Motor/Actuator Driver DC Brush Motor Series

40V/3A Rating H Bridge Driver for Automotive

BD16912EFV-C

General Description

BD16912EFV-C is a 1-ch H-bridge DMOS FET driver for automotive application. High efficiency driving is possible by direct PWM control or constant current PWM control. It is equipped with Output Current Detection Amplifier, Abnormality Detection Signal Output, low ON resistance and small package, contributing to high reliability, low power consumption and space saving of the set.

Features

- AEC-Q100 Qualified (Note 1)
- Small Package with Backside Exposed PAD
- Driver with Built-in Power DMOS FET
- 2 Input Control (Forward Rotation, Reverse Rotation, Idle Rotation, Brake)
- Direct PWM Control
- Constant Current PWM Control (Current limit)
- Power Save (Standby)
- Through Current Prevention
- Output Current Detection Amplifier
- Abnormality Detection Signal Output
- Abnormality Detection (Over Current, Over Voltage, Thermal Shutdown: TSD, Thermal Warning: TW)
- Output Protection (Over Current, Over Voltage, Thermal Shutdown: TSD)
- Under Voltage Lock Out: UVLO (Note 1) Grade 1

Key Specifications

- Operating Power Supply Voltage Range: 6 V to 18 V
- Motor Drive Output Current Rating: 3 A
- Junction Temperature Range: -40 °C to +150 °C
- Motor Drive Output ON Resistance (Sum of High Side and Low Side): 0.36 Ω during $V_{DS}=12$ V (Typ)

Package

HTSSOP-B20

W (Typ) x D (Typ) x H (Max)
6.50 mm x 6.40 mm x 1.00 mm



Application

- Automotive DC Brush Motor

Typical Application Circuit

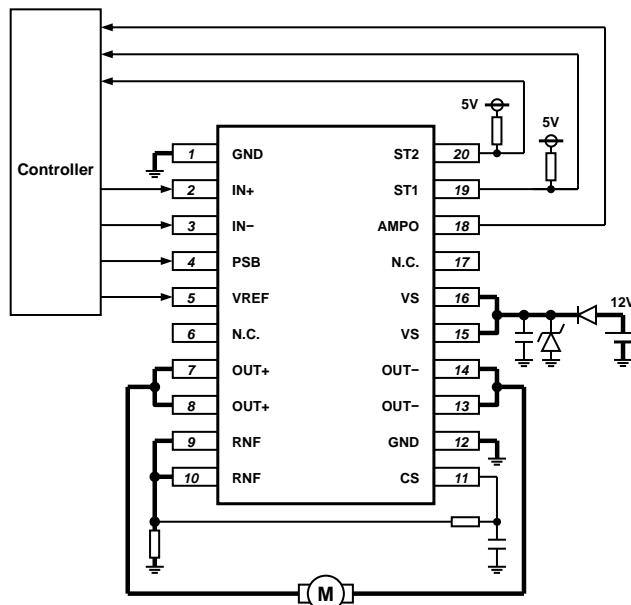

Figure 1. Basic Application Circuit

Contents

General Description	1
Features.....	1
Key Specifications	1
Package.....	1
Application	1
Typical Application Circuit	1
Contents	2
Absolute Maximum Ratings	3
Recommended Operating Conditions	3
Thermal Resistance.....	3
Pin Configuration	4
Block Diagram	4
Pin Description.....	4
I / O Truth Table	5
Electrical Characteristics.....	6
Typical Performance Curves.....	8
Application Example	24
1. Variable Speed Control Application by Direct PWM Control	24
2. Variable Speed Control Application by Constant Current PWM Control	25
Description of Blocks	26
1. Under Voltage Lock Out: UVLO.....	26
2. Over Voltage Protection: OVP	26
3. Over Current Protection: OCP	27
4. Thermal Warning: TW, Thermal Shutdown: TSD	28
5. Direct PWM Control.....	29
6. Output Current Detection Amp (AMPO Pin)	30
7. Constant Current PWM Control (Current Limit)	30
8. Power Save (PSB Pin)	31
I / O Equivalence Circuits.....	32
Heat Loss.....	33
1. Thermal Resistance.....	33
2. Power Dissipation.....	33
3. Thermal De-rating Curve	33
Safety Measures.....	34
1. Countermeasure against Destruction of Reverse Connection Power Supply	34
2. Measures to Raise the Power Supply Pin Voltage by Back Electromotive Force	34
3. Countermeasures against Unstable Power Supply	35
4. Prohibition of Ground Line PWM Switching Input.....	35
Operational Notes.....	36
Ordering Information	38
Marking Diagram	38
Physical Dimension and Packing Information	39
Revision History.....	40

Absolute Maximum Ratings (Ta=25°C)

Parameter	Symbol	Rating	Unit
Power Supply Voltage	V _{VS}	-0.3 to +40	V
Motor Drive Output (OUT+, OUT-) Voltage	V _O	-0.3 to +40	V
Motor Drive Output (OUT+, OUT-) Current	I _O	-3.0 to +3.0 ^(Note 1)	A
Motor Drive Ground (RNF) Voltage	V _{RNF}	-0.3 to +1	V
Abnormality Detection Signal (ST1, ST2) Output Voltage	V _{ST}	-0.3 to +7	V
Abnormality Detection Signal (ST1, ST2) Output Current	I _{ST}	0 to 10	mA
Motor Drive Current Detection Signal (AMPO) Output Voltage	V _{AMPO}	-0.3 to +3.6	V
Motor Drive Current Detection Signal (AMPO) Output Current	I _{AMPO}	-0.05 to +0.3	mA
Control Input Voltage (IN+, IN-, PSB, CS, VREF)	V _{IN}	-0.3 to +7	V
Junction Temperature	T _J	-40 to +150	°C
Storage Temperature Range	T _{stg}	-55 to +150	°C

For the current parameter, the current inflow into the IC is indicated as a positive notation, and the current outflow from the IC as a negative notation.

(Note 1) Do not exceed power dissipation (Pd), and area of safe operation (ASO).

The power dissipation is determined by the maximum junction temperature, the thermal resistance in the board's mounted state, and the ambient temperature.

Caution 1: Operating the IC over the absolute maximum ratings may damage the IC. The damage can either be a short circuit between pins or an open circuit between pins and the internal circuitry. Therefore, it is important to consider circuit protection measures, such as adding a fuse, in case the IC is operated over the absolute maximum ratings.

Caution 2: Should by any chance the maximum junction temperature rating be exceeded the rise in temperature of the chip may result in deterioration of the properties of the chip. In case of exceeding this absolute maximum rating, design a PCB boards with thermal resistance taken into consideration by increasing board size and copper area so as not to exceed the maximum junction temperature rating.

Recommended Operating Conditions

Parameter	Symbol	Limit			Unit
		Min	Typ	Max	
Power Supply Voltage	V _{VS}	6	12	18	V
Operating Temperature	T _{opr}	-40	-	+125	°C
Control Input PWM Frequency (IN+, IN-)	f _{PWM}	-	-	100	kHz

Thermal Resistance^(Note 2)

Parameter	Symbol	Thermal Resistance (Typ)		Unit
		1s ^(Note 4)	2s2p ^(Note 5)	
HTSSOP-B20				
Junction to Ambient	θ _{JA}	143.0	26.8	°C/W
Junction to Top Characterization Parameter ^(Note 3)	Ψ _{JT}	8	4	°C/W

(Note 2) Based on JESD51-2A(Still-Air).

(Note 3) The thermal characterization parameter to report the difference between junction temperature and the temperature at the top center of the outside surface of the component package.

(Note 4) Using a PCB board based on JESD51-3.

(Note 5) Using a PCB board based on JESD51-5, 7.

Layer Number of Measurement Board	Material	Board Size
Single	FR-4	114.3 mm x 76.2 mm x 1.57 mmt

Top	
Copper Pattern	Thickness
Footprints and Traces	70 μm

Layer Number of Measurement Board	Material	Board Size	Thermal Via ^(Note 6)	
			Pitch	Diameter
4 Layers	FR-4	114.3 mm x 76.2 mm x 1.6 mmt	1.20 mm	Φ0.30 mm

Top		2 Internal Layers		Bottom	
Copper Pattern	Thickness	Copper Pattern	Thickness	Copper Pattern	Thickness
Footprints and Traces	70 μm	74.2 mm x 74.2 mm	35 μm	74.2 mm x 74.2 mm	70 μm

(Note 6) This thermal via connects with the copper pattern of all layers.

Pin Configuration

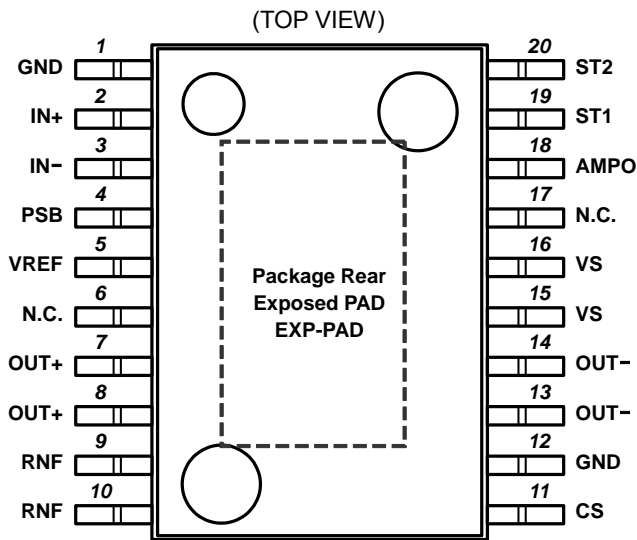

Block Diagram

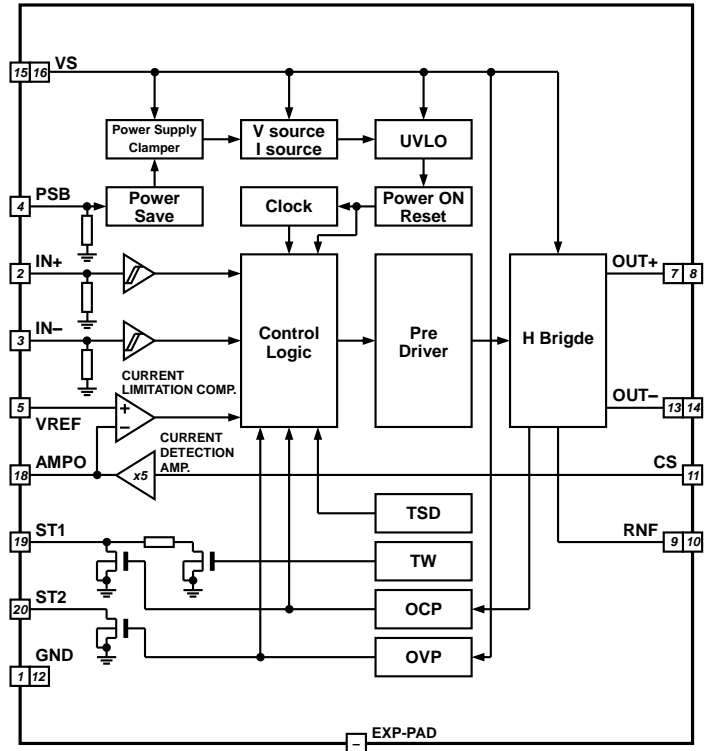

Pin Description

Pin No.	Pin Name	Function	Pin No.	Pin Name	Function
1	GND	Ground (small signal ground)	11	CS	Motor output current detection amplifier input
2	IN+	Motor drive logic input +	12	GND	Ground (small signal ground)
3	IN-	Motor drive logic input -	13	OUT-	Motor drive output -
4	PSB	Power save input	14	OUT-	Motor drive output -
5	VREF	Motor drive current setting voltage input	15	VS	Power supply
6	N.C.	No connection	16	VS	Power supply
7	OUT+	Motor drive output +	17	N.C.	No connection
8	OUT+	Motor drive output +	18	AMPO	Motor output current detection amplifier output
9	RNF	Motor drive ground	19	ST1	Abnormality detection signal 1 output
10	RNF	Motor drive ground	20	ST2	Abnormality detection signal 2 output
-	EXP-PAD	Package rear exposed PAD	-	EXP-PAD	Package rear exposed PAD

Although the unconnected pin (NC) is not connected inside the IC, there is a possibility of causing unexpected troubles such as oscillation, so open on the board pattern without making it as a relay point for other wiring.

Motor drive related pins (VS, RNF, OUT+, OUT-) are short-circuited within the IC within the same name, but in order to lower the impedance of the motor drive current path, short between the same name pins on the board pattern.

Package Rear Exposed PAD should be at the same potential as the ground pin.

I / O Truth Table

Driver Input			Driver Output		Signal Output (During Resistance Pull-up for ST1 and ST2)			Driver Output State Name
PSB	IN+	IN-	OUT+	OUT-	ST1	ST2	AMPO	
L	X	X	Hi-Z	Hi-Z	H	H	L	Power Save
H	L	L	Hi-Z	Hi-Z	Active	Active	Active	Idle Rotation
H	H	L	H	L	Active	Active	Active	Forward Rotation
H	L	H	L	H	Active	Active	Active	Reverse Rotation
H	H	H	L	L	Active	Active	Active	Brake

H: High, L: Low, X: Don't care, Hi-Z: High impedance

Driver State					Driver Output		Signal Output ^(Note 1) (During Resistance Pull-up for ST1 and ST2)		
UVLO	OCP	TW	TSD	OVP	OUT+	OUT-	ST1	ST2	AMPO
Disable	Disable	Disable	Disable	Disable	Active	Active	H	H	Active
Enable	X	X	X	X	Hi-Z	Hi-Z	H	H	L
Disable	Enable	Disable	Disable	Disable	Hi-Z	Hi-Z	L	H	Active
Disable	Disable	Enable	Disable	Disable	Active	Active	M	H	Active
Disable	Disable	Enable	Enable	Disable	Hi-Z	Hi-Z	M	H	Active
Disable	Enable	Enable	Disable	Disable	Hi-Z	Hi-Z	L	H	Active
Disable	Enable	Enable	Enable	Disable	Hi-Z	Hi-Z	L	H	Active
Disable	Disable	Disable	Disable	Enable	L	L	H	L	Active
Disable	Enable	Disable	Disable	Enable	Hi-Z	Hi-Z	L	L	Active
Disable	Disable	Enable	Disable	Enable	L	L	M	L	Active
Disable	Disable	Enable	Enable	Enable	Hi-Z	Hi-Z	M	L	Active
Disable	Enable	Enable	Disable	Enable	Hi-Z	Hi-Z	L	L	Active
Disable	Enable	Enable	Enable	Enable	Hi-Z	Hi-Z	L	L	Active

H: High, M: Middle, L: Low, X: Don't care, Hi-Z: High impedance

If both IN+ and IN- are Low, driver output goes to Hi-Z although over voltage is detected.

(Note 1) 4.7 kΩ for ST1, Middle for pull up

Electrical Characteristics

(Unless otherwise specified Tj=-40 °C to +150 °C, V_{VS}=6 V to 18 V, V_{PSB}=5 V, V_{CS}=V_{RNF}=0 V, V_{VREF}=5 V)

Parameter	Symbol	Limit			Unit	Condition
		Min	Typ	Max		
Circuit Current (During Operation)	I _Q	-	3	6	mA	V _{PSB} =H
Circuit Current (At Standby)	I _{STBY1}	-	0	10	μA	V _{PSB} =L, Tj=-40 °C to +125 °C
Circuit Current (At Standby)	I _{STBY2}	-	-	40	μA	V _{PSB} =L, Tj=+125 °C to +150 °C
Motor Drive Output ON Resistance 1	R _{ON1}	-	0.40	0.59	Ω	V _{VS} =6 V to 12 V, I _O =±2 A, Tj=+25 °C, Sum of High Side and Low Side
Motor Drive Output ON Resistance 2	R _{ON2}	-	0.36	0.56	Ω	V _{VS} =12 V to 18 V, I _O =±2 A, Tj=+25 °C, Sum of High Side and Low Side
Motor Drive Output ON Resistance 3 (Reference Value) (Note 1)	R _{ON3}	-	-	0.45	Ω	V _{VS} =6 V to 12 V, I _O =±2 A, Tj=-40 °C, Sum of High Side and Low Side
Motor Drive Output ON Resistance 4 (Reference Value) (Note 1)	R _{ON4}	-	-	0.88	Ω	V _{VS} =6 V to 12 V, I _O =±2 A, Tj=+150 °C, Sum of High Side and Low Side
Motor Drive Output ON Resistance 5 (Reference Value) (Note 1)	R _{ON5}	-	-	0.43	Ω	V _{VS} =12 V to 18 V, I _O =±2 A, Tj=-40 °C, Sum of High Side and Low Side
Motor Drive Output ON Resistance 6 (Reference Value) (Note 1)	R _{ON6}	-	-	0.83	Ω	V _{VS} =12 V to 18 V, I _O =±2 A, Tj=+150 °C, Sum of High Side and Low Side
Motor Drive Output Higher-Side Body Diode Voltage 1	V _{FOH1}	-	1.0	1.3	V	I _O =+2 A, Tj=+25 °C
Motor Drive Output Higher-Side Body Diode Voltage 2 (Reference Value) (Note 1)	V _{FOH2}	-	-	1.4	V	I _O =+2 A, Tj=-40 °C
Motor Drive Output Higher-Side Body Diode Voltage 3 (Reference Value) (Note 1)	V _{FOH3}	-	-	1.2	V	I _O =+2 A, Tj=+150 °C
Motor Drive Output Lower-Side Body Diode Voltage 1	V _{FOL1}	-	1.0	1.3	V	I _O =-2 A, Tj=+25 °C
Motor Drive Output Lower-Side Body Diode Voltage 2 (Reference Value) (Note 1)	V _{FOL2}	-	-	1.4	V	I _O =-2 A, Tj=-40 °C
Motor Drive Output Lower-Side Body Diode Voltage 3 (Reference Value) (Note 1)	V _{FOL3}	-	-	1.2	V	I _O =-2 A, Tj=+150 °C
Motor Drive Output Higher-Side Leakage Current	I _{OLH}	-40	-	-	μA	V _O =0 V
Motor Drive Output Lower-Side Leakage Current	I _{OLL}	-	-	20	μA	V _O =V _{VS}
Abnormality Detection Signal ST1 Output Middle Output Impedance (Reference Value) (Note 1)	R _{ST1}	3.3	4.7	6.1	kΩ	I _{ST1} =+0.5 mA, Thermal Warning (TW)
Abnormality Detection Signal ST1 Output Low Voltage	V _{STL1}	-	0.1	0.3	V	I _{ST1} =+1.1 mA, Overcurrent Detection
Abnormality Detection Signal ST2 Output Low Voltage	V _{STL2}	-	0.1	0.3	V	I _{ST2} =+1.1 mA, Overvoltage Detection
Abnormality Detection Signal Output Leakage Current	I _{ST}	-	-	10	μA	V _{ST} =7 V
Motor Drive Logic Input High Level Input Voltage	V _{INH}	2.5	-	-	V	
Motor Drive Logic Input Low Level Input Voltage	V _{INL}	-	-	0.8	V	
Motor Drive Logic Input High Level Input Current	I _{INH}	25	50	100	μA	V _{IN+} , V _{IN-} =5 V
Motor Drive Logic Input Low Level Input Current	I _{INL}	-10	0	+10	μA	V _{IN+} , V _{IN-} =0 V

For the current parameter, the current inflow into the IC is indicated as a positive notation, and the current outflow from the IC as a negative notation.

(Note 1) Reference value is the design value on which evaluation confirmation was carried out, and shipment inspection is not carried out.

Electrical Characteristics - continued

(Unless otherwise specified Tj=-40 °C to +150 °C, V_{VS}=6 V to 18 V, V_{PSB}=5 V, V_{CS}=V_{RNF}=0 V, V_{VREF}=5 V)

Parameter	Symbol	Limit			Unit	Condition
		Min	Typ	Max		
Power Save Input High Voltage	V _{PSBH}	2.7	-	-	V	
Power Save Input Low Voltage	V _{PSBL}	-	-	0.8	V	
Power Save Input High Current	I _{PSBH}	25	50	100	μA	V _{PSB} =5 V
Power Save Input Low Current	I _{PSBL}	-10	0	+10	μA	V _{PSB} =0 V
CS Pin Input Bias Current	I _{CS}	-0.1	0	+0.1	μA	V _{CS} =0 V to 1 V
VREF Pin Input Bias Current	I _{VREF}	-0.1	0	+0.1	μA	V _{VREF} =0 V to 5 V
Motor Drive Current Setting Input Voltage Range (Constant Current PWM Control Setting Range)	V _{RVREF}	0	-	2.8	V	
AMPO Output Saturation Voltage	V _{AMPOMAX}	-	3.0	3.2	V	V _{CS} =0.7 V
Current Limit Comparator Offset Voltage	V _{OFFSET}	-20	0	+20	mV	V _{AMPO} =0 V to 2.8 V
Motor Output Current Detection Amplifier Output Voltage 1	V _{AMPO1}	0.4	0.5	0.6	V	V _{CS1} =0.1 V
Motor Output Current Detection Amplifier Output Voltage 2	V _{AMPO2}	2.25	2.5	2.75	V	V _{CS2} =0.5 V
Motor Output Current Detection Amplifier Gain	G _{AMP}	4.8	5.0	5.2	V/V	$G_{AMP}=(V_{AMPO2}-V_{AMPO1})/(V_{CS2}-V_{CS1})$
Constant Current PWM Control Carrier Frequency	f _{VREF}	19	33	49	kHz	For Constant Current PWM Control
OCP Detect Current	I _{OCP}	3.0	-	8.0	A	
OCP Output ON Time (Reference Value) ^(Note 1)	t _{ON}	-	0.4	0.7	μs	
OCP Output OFF Time	t _{OFF}	2	4	8	ms	
OVP Detect Voltage	V _{OVPON}	30	33	36	V	
OVP Hysteresis	V _{OVPHYS}	-	2	-	V	
TSD Detect Temperature (Reference Value) ^(Note 1)	T _{TSDON}	150	175	200	°C	
TSD Hysteresis (Reference Value) ^(Note 1)	T _{TSDHYS}	-	25	-	°C	
TW Detect Temperature (Reference Value) ^(Note 1)	T _{TWON}	135	160	185	°C	
TW Hysteresis (Reference Value) ^(Note 1)	T _{TWHYS}	-	25	-	°C	
UVLO Detect Voltage	V _{UVLOON}	4.5	5.0	5.5	V	
UVLO Hysteresis	V _{UVLOHYS}	-	0.5	-	V	
Motor Drive I/O Delay Time ^(Note 2)	t _{INOUT}	-	-	10	μs	From IN+, IN- to OUT+, OUT-

For the current parameter, the current inflow into the IC is indicated as a positive notation, and the current outflow from the IC as a negative notation.^(Note 1) Reference value is the design value on which evaluation confirmation was carried out, and shipment inspection is not carried out.^(Note 2) t_{INOUT} is total delay time of logic and through current prevention.

Typical Performance Curves

(Reference Data)

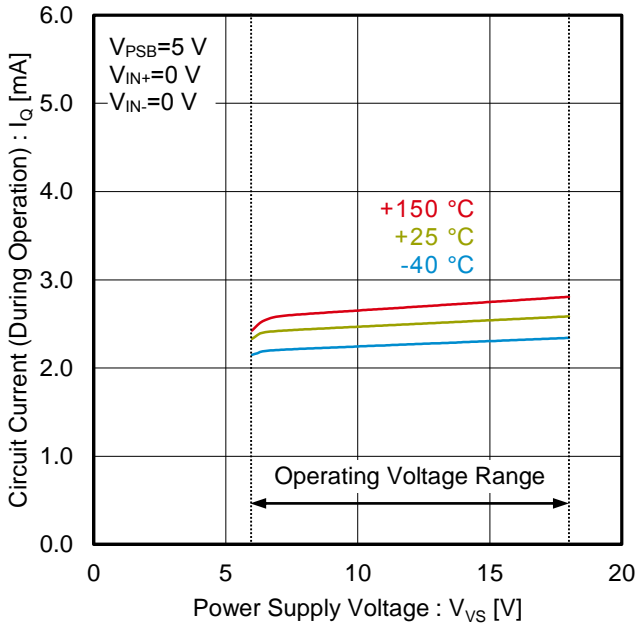

Figure 2. Circuit Current vs Power Supply Voltage (During Operation, $V_{IN+}/V_{IN-}=L/L$)

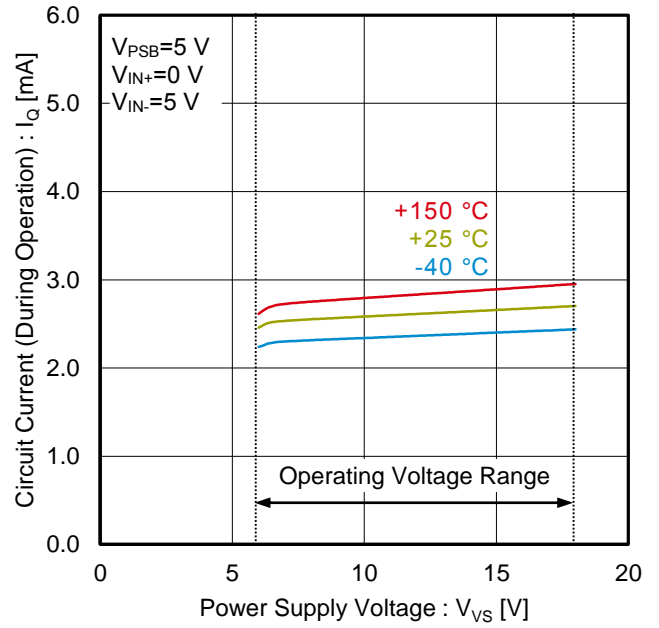

Figure 3. Circuit Current vs Power Supply Voltage (During Operation, $V_{IN+}/V_{IN-}=L/H$)

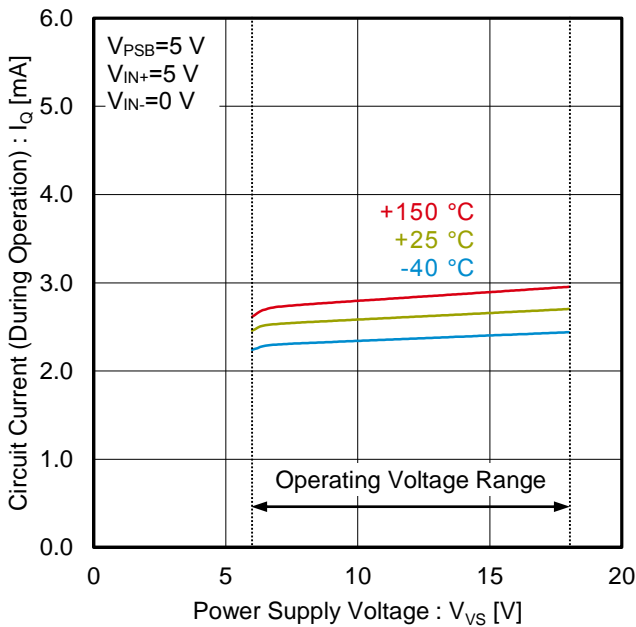

Figure 4. Circuit Current vs Power Supply Voltage (During Operation, $V_{IN+}/V_{IN-}=H/L$)

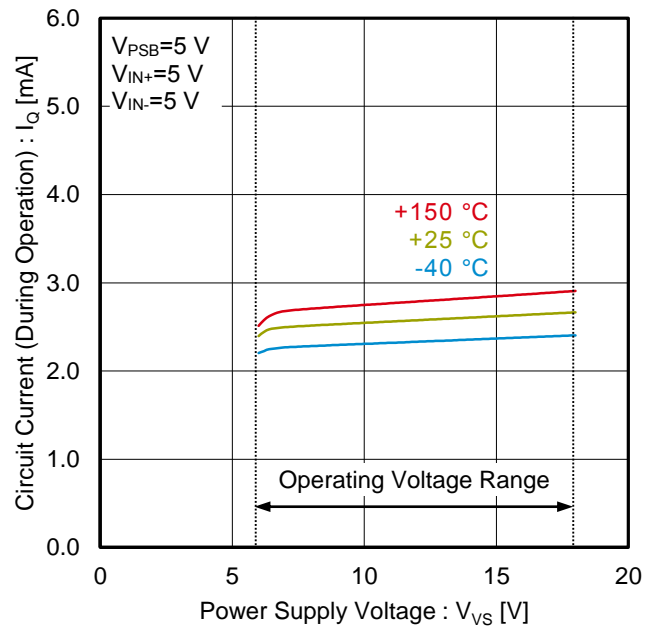

Figure 5. Circuit Current vs Power Supply Voltage (During Operation, $V_{IN+}/V_{IN-}=H/H$)

Typical Performance Curves - continued
(Reference Data)

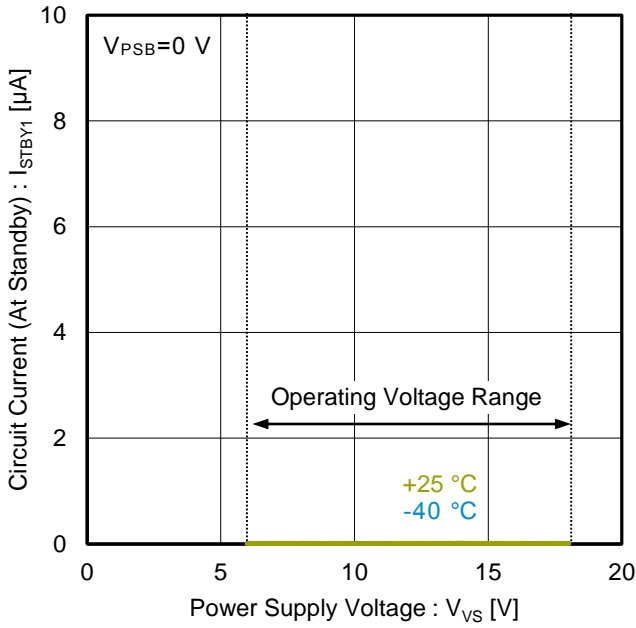

Figure 6. Circuit Current vs Power Supply Voltage (At Standby)

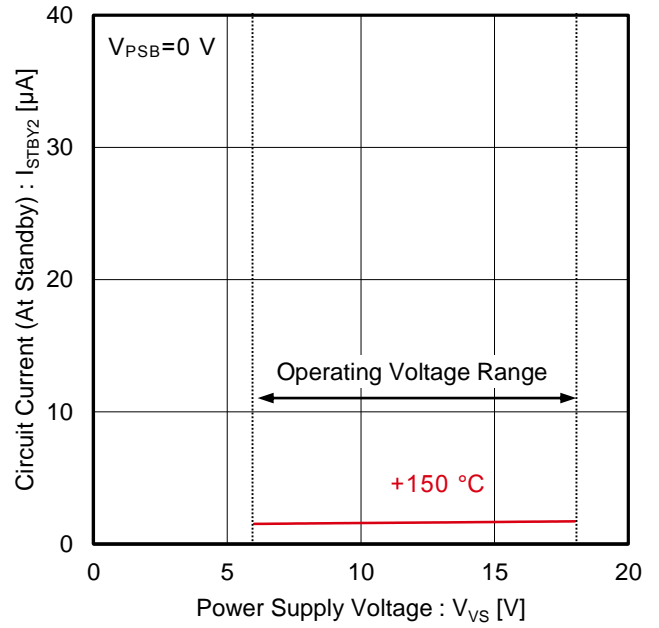

Figure 7. Circuit Current vs Power Supply Voltage (At Standby)

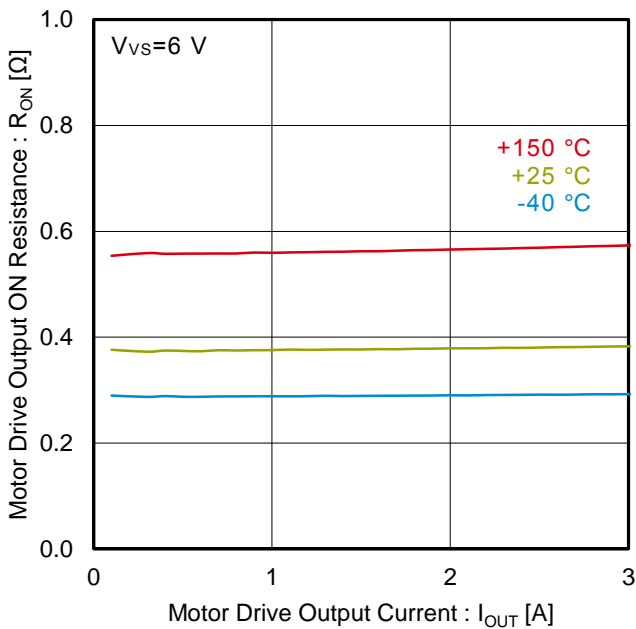

Figure 8. Motor Drive Output ON Resistance vs Motor Drive Output Current (Sum of OUT+ High Side + OUT- Low Side)

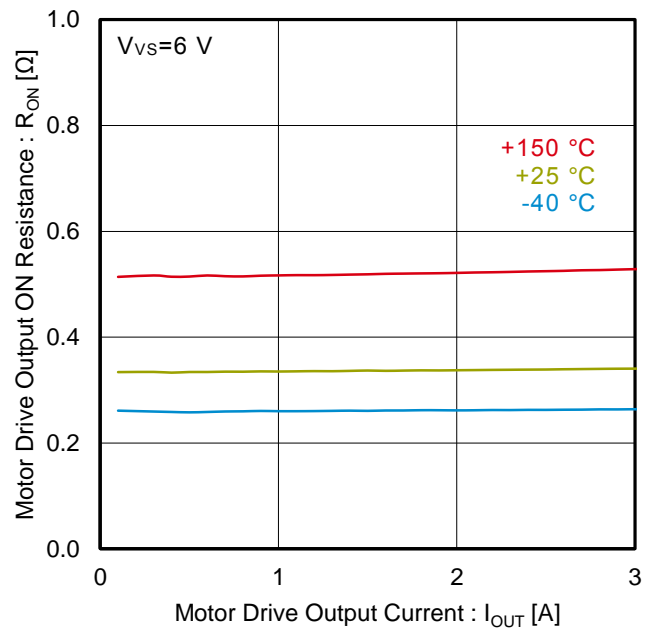

Figure 9. Motor Drive Output ON Resistance vs Motor Drive Output Current (Sum of OUT+ Low Side + OUT- High Side)

Typical Performance Curves - continued
(Reference Data)

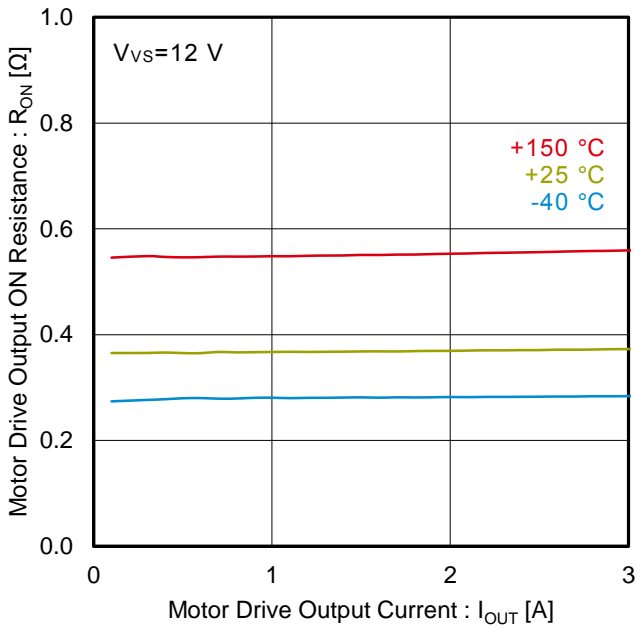

Figure 10. Motor Drive Output ON Resistance vs Motor Drive Output Current (Sum of OUT+ High Side + OUT- Low Side)

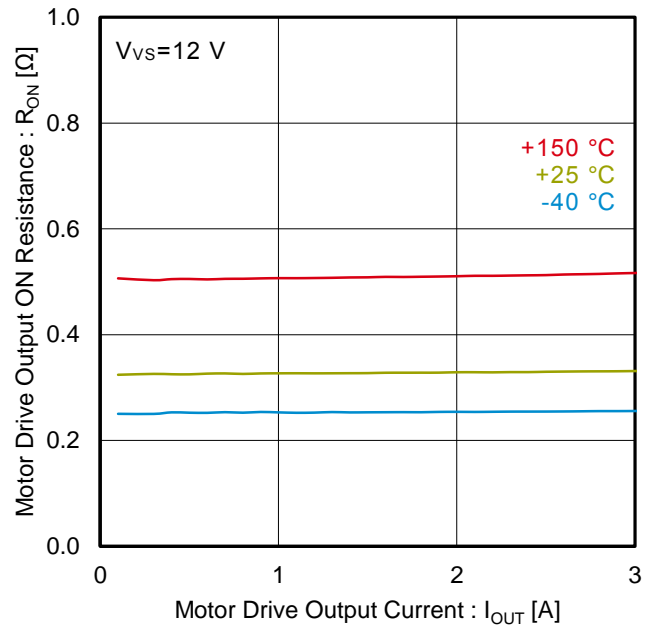

Figure 11. Motor Drive Output ON Resistance vs Motor Drive Output Current (Sum of OUT+ Low Side + OUT- High Side)

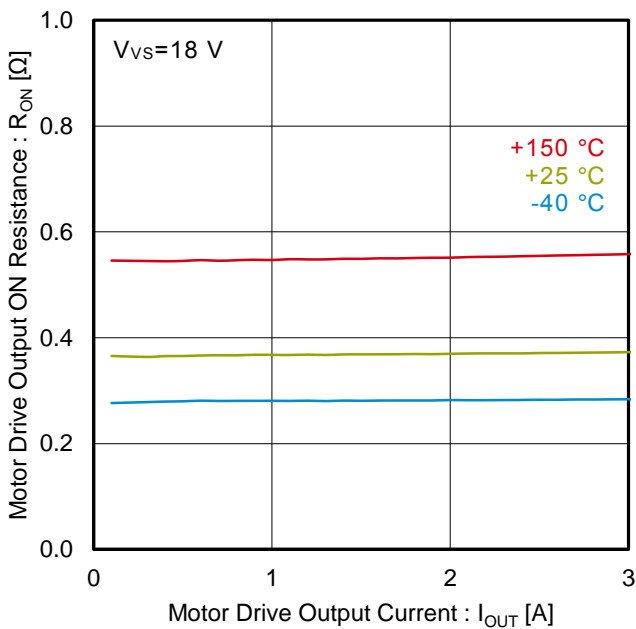

Figure 12. Motor Drive Output ON Resistance vs Motor Drive Output Current (Sum of OUT+ High Side + OUT- Low Side)

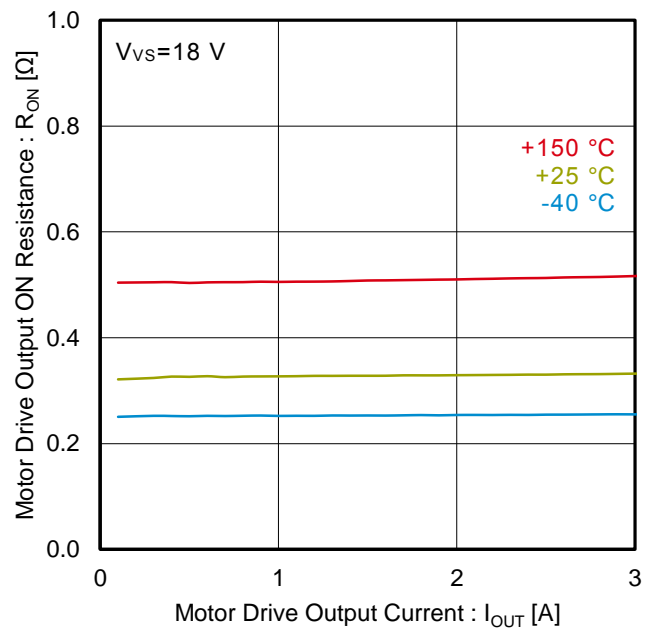

Figure 13. Motor Drive Output ON Resistance vs Motor Drive Output Current (Sum of OUT+ Low Side + OUT- High Side)

Typical Performance Curves - continued

(Reference Data)

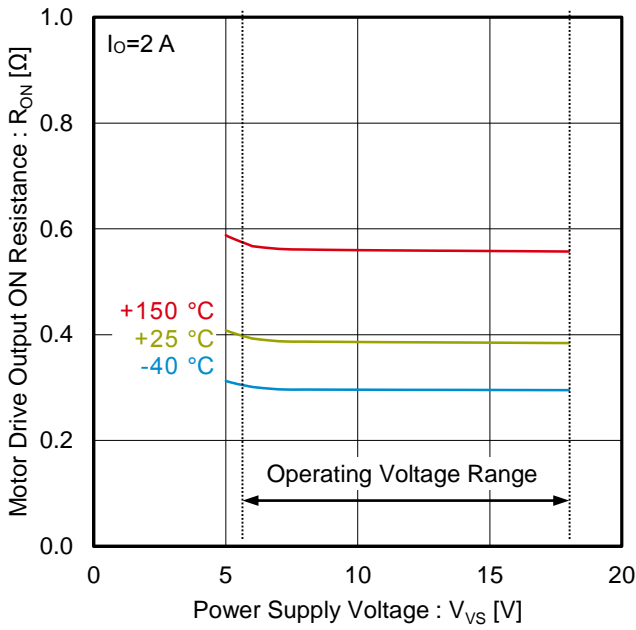

Figure 14. Motor Drive Output ON Resistance vs Power Supply Voltage (Sum of OUT+ High Side + OUT- Low Side)

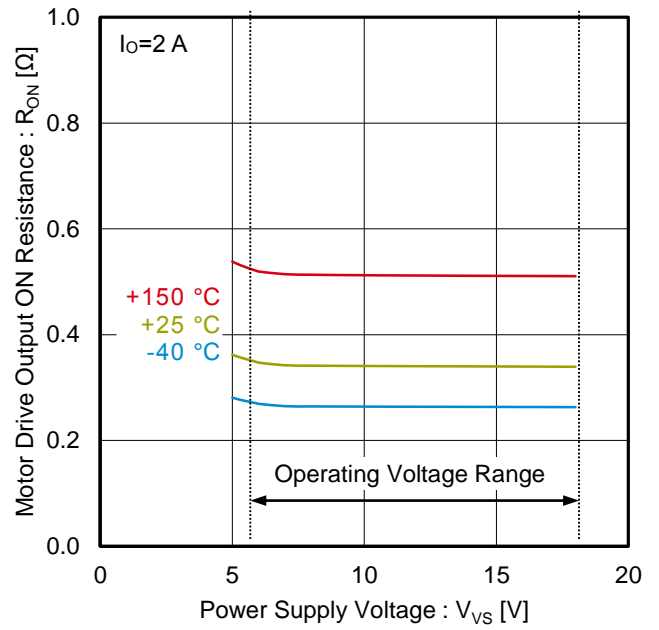

Figure 15. Motor Drive Output ON Resistance vs Power Supply Voltage (Sum of OUT+ Low Side + OUT- High Side)

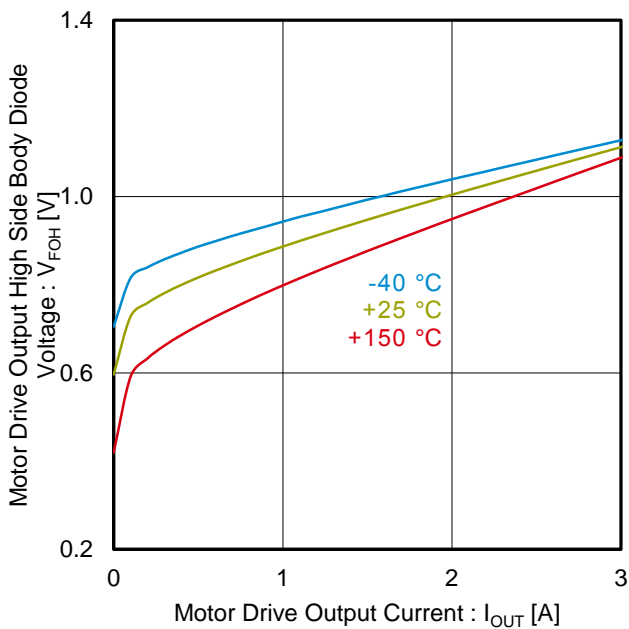

Figure 16. Motor Drive Output High Side Body Diode Voltage vs Motor Drive Output Current (OUT+)

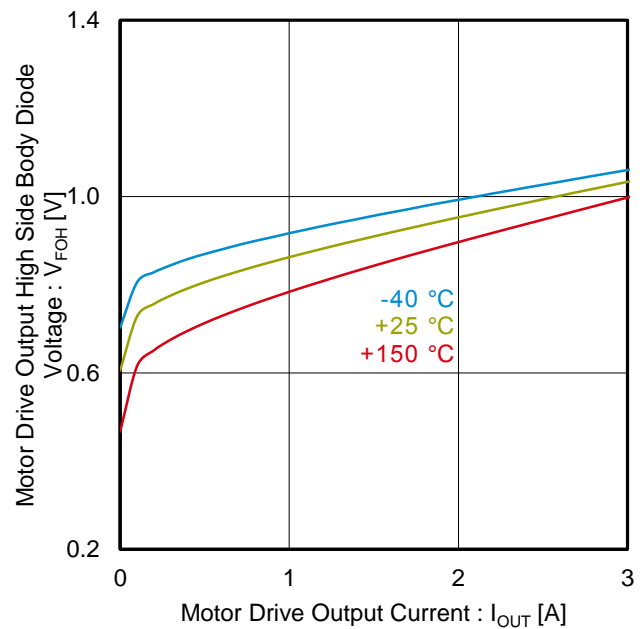

Figure 17. Motor Drive Output High Side Body Diode Voltage vs Motor Drive Output Current (OUT-)

Typical Performance Curves - continued
(Reference Data)

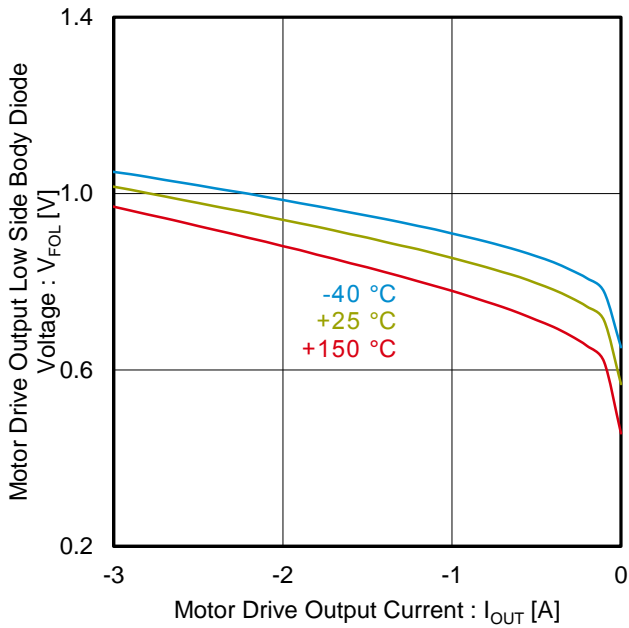

Figure 18. Motor Drive Output Low Side Body Diode Voltage vs Motor Drive Output Current (OUT+)

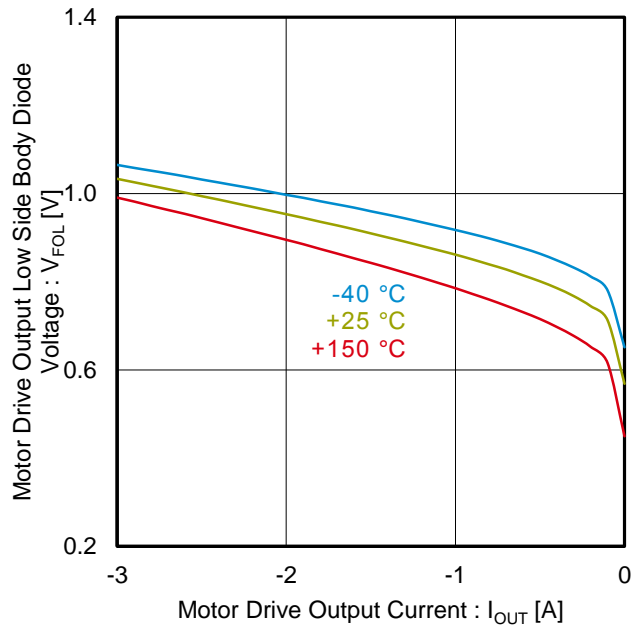

Figure 19. Motor Drive Output Low Side Body Diode Voltage vs Motor Drive Output Current (OUT-)

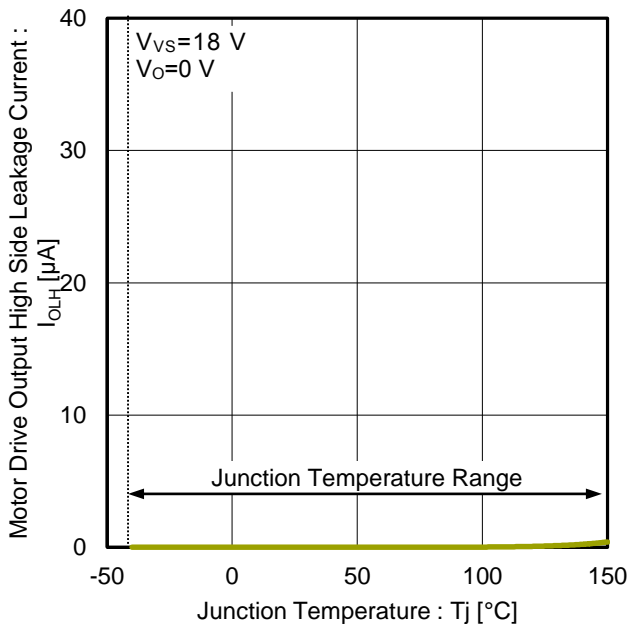

Figure 20. Motor Drive Output Higher-Side Leakage Current vs Junction Temperature (OUT+)

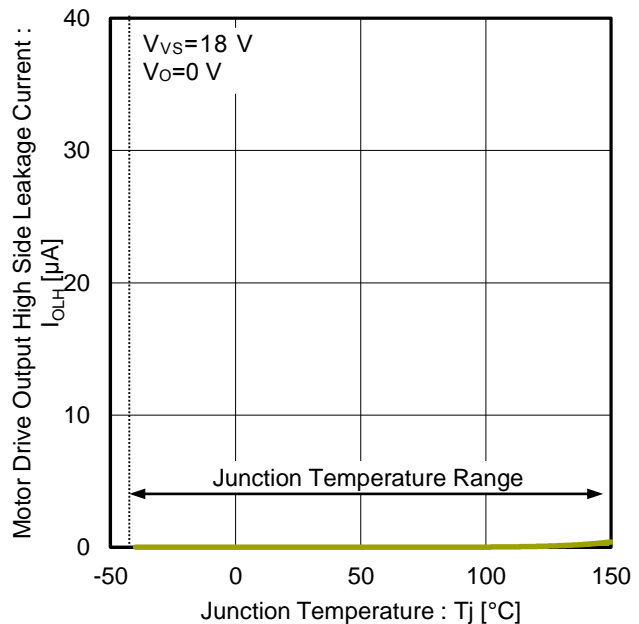

Figure 21. Motor Drive Output Higher-Side Leakage Current vs Junction Temperature (OUT-)

Typical Performance Curves - continued
(Reference Data)

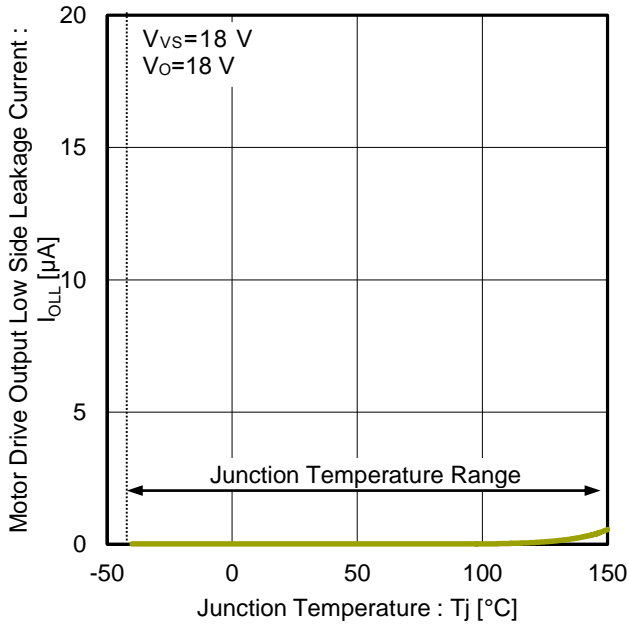

Figure 22. Motor Drive Output Lower-Side Leakage Current vs Junction Temperature (OUT+)

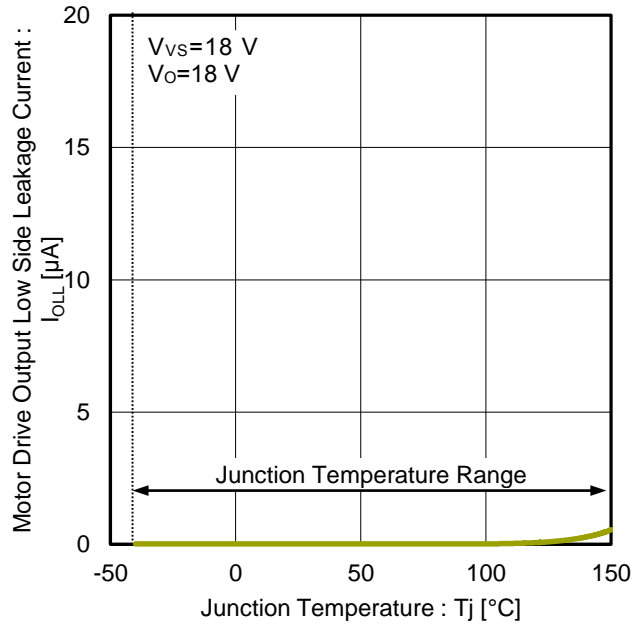

Figure 23. Motor Drive Output Lower-Side Leakage Current vs Junction Temperature (OUT-)

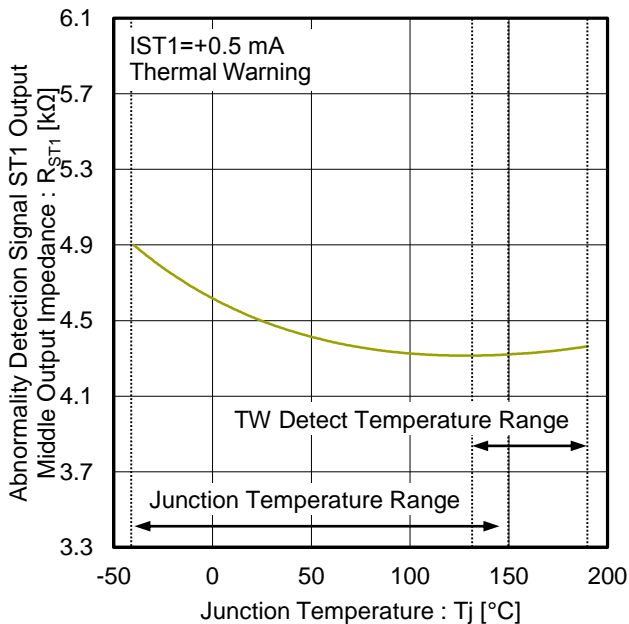

Figure 24. Abnormality Detection Signal ST1 Output Middle Output Impedance vs Junction Temperature

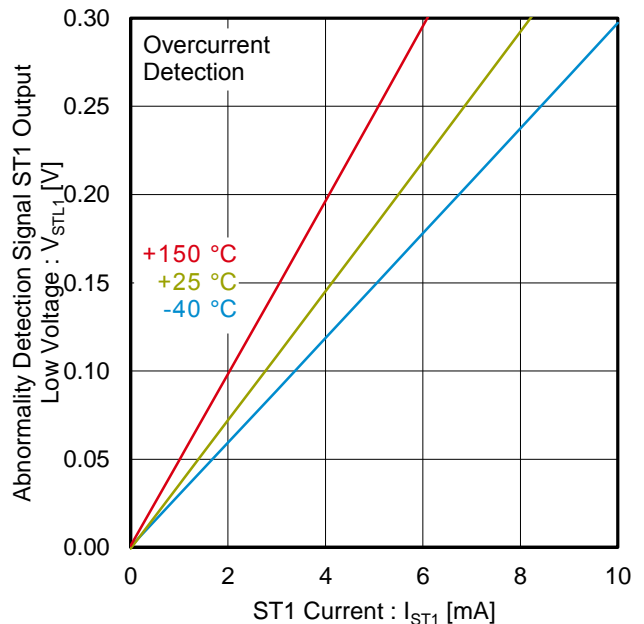

Figure 25. Abnormality Detection Signal ST1 Output Low Voltage vs ST1 Current

Typical Performance Curves - continued
(Reference Data)

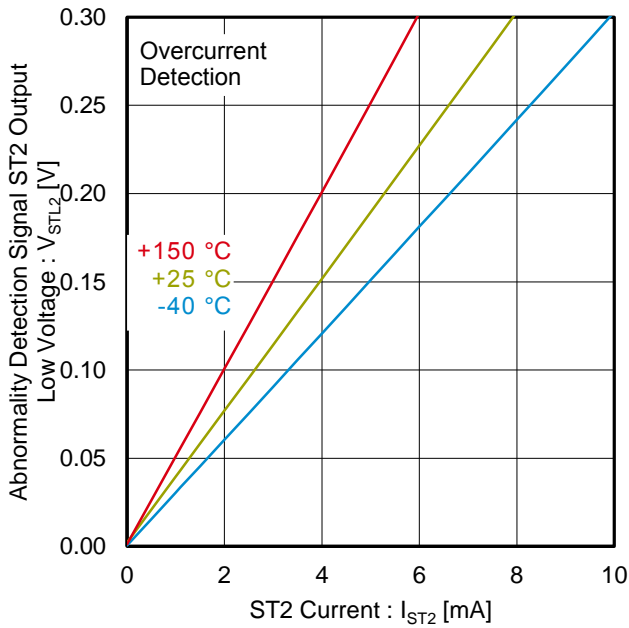

Figure 26. Abnormality Detection Signal ST2 Output Low Voltage vs ST2 Current

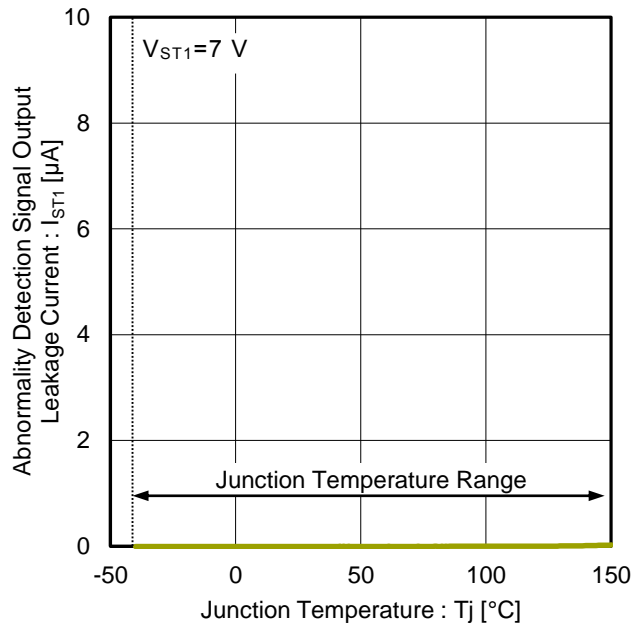

Figure 27. Abnormality Detection Signal Output Leakage Current vs Junction Temperature (ST1)

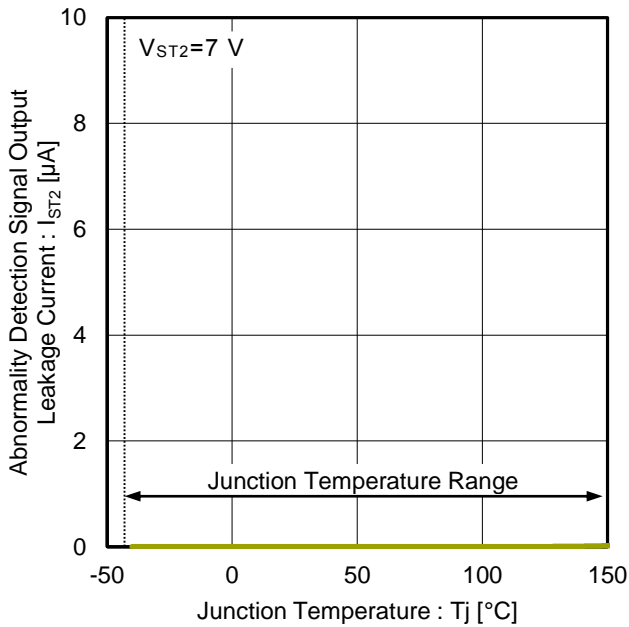

Figure 28. Abnormality Detection Signal Output Leakage Current vs Junction Temperature (ST2)

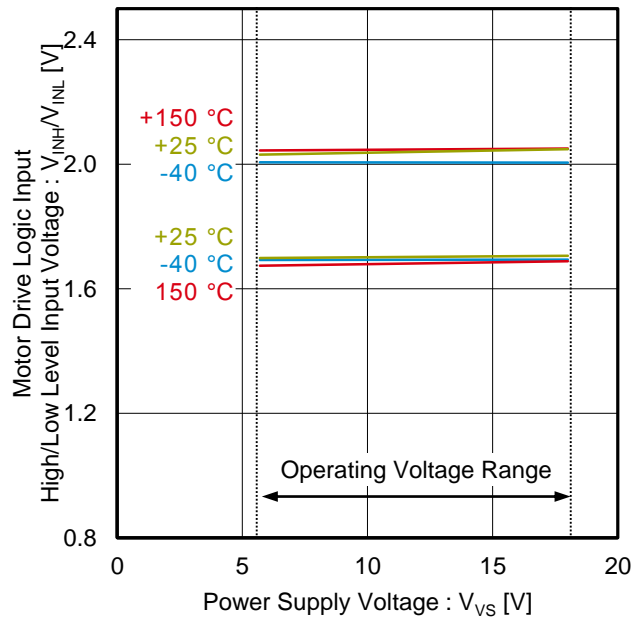

Figure 29. Motor Drive Logic Input High/Low Level Input Voltage vs Power Supply Voltage (IN+)

Typical Performance Curves - continued

(Reference Data)

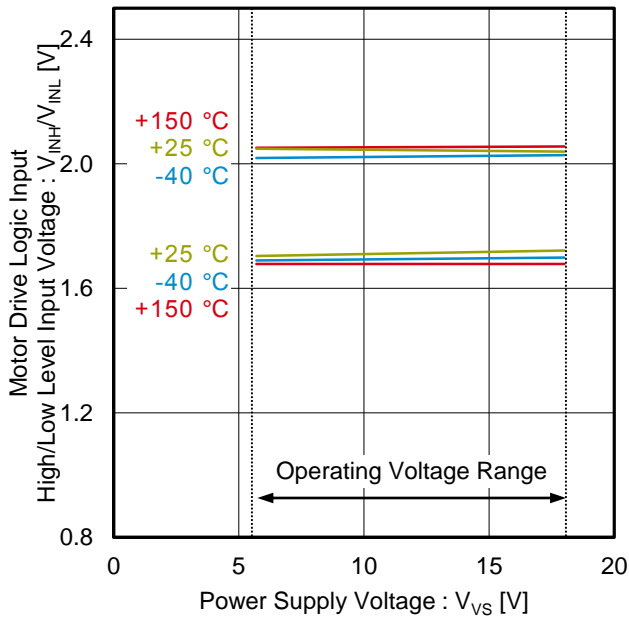

Figure 30. Motor Drive Logic Input High/Low Level Input Voltage vs Power Supply Voltage (IN-)

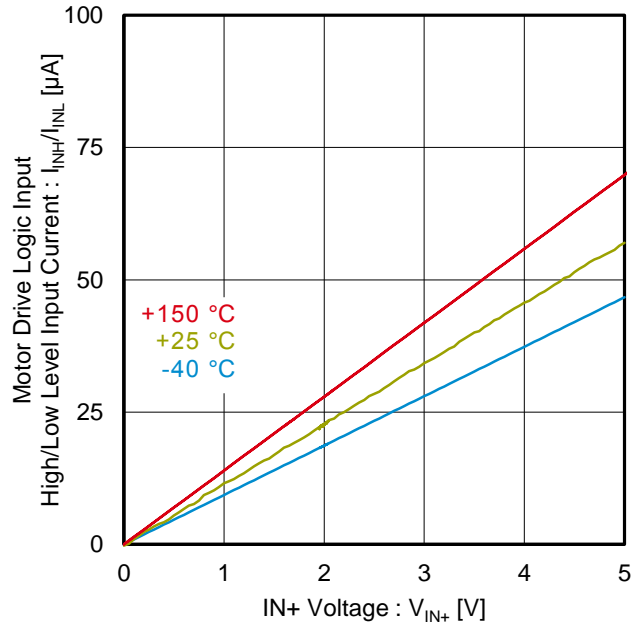

Figure 31. Motor Drive Logic Input High/Low Level Input Current vs Control Input Voltage (IN+)

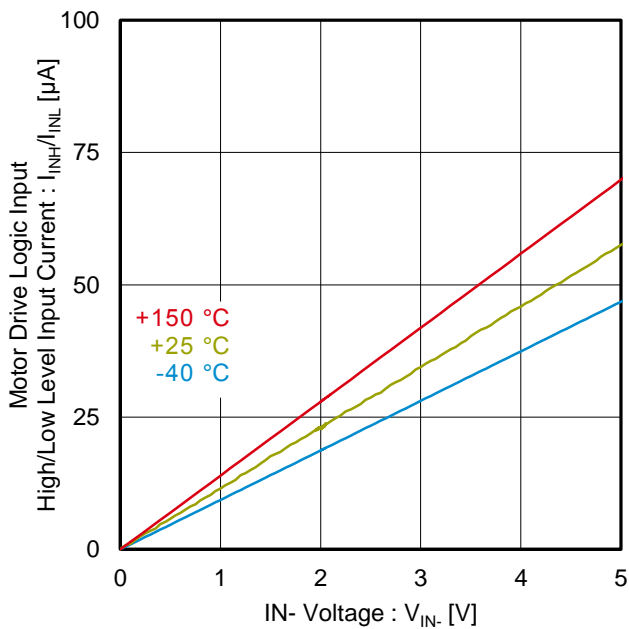

Figure 32. Motor Drive Logic Input High/Low Level Input Current vs Control Input Voltage (IN-)

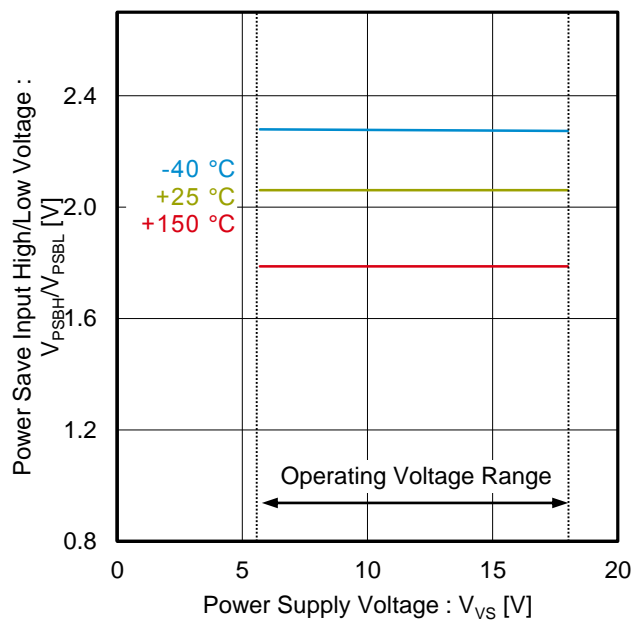

Figure 33. Power Save Input High/Low Voltage vs Power Supply Voltage

Typical Performance Curves - continued
(Reference Data)

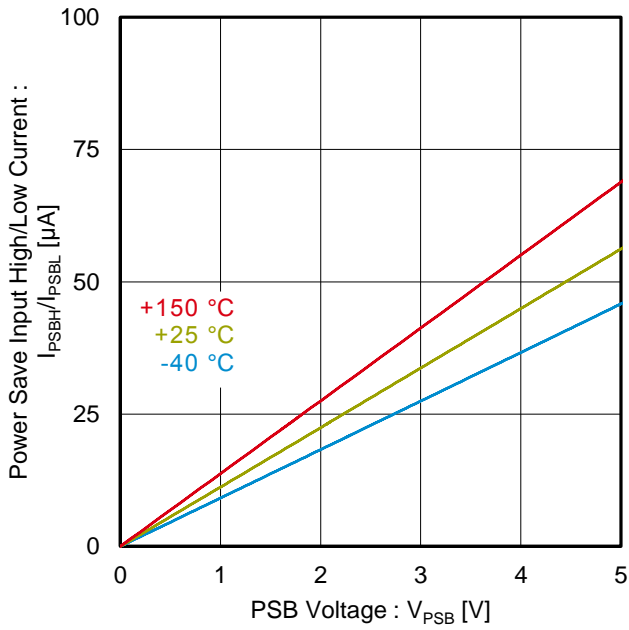

Figure 34. Power Save Input High/Low Current vs PSB Voltage

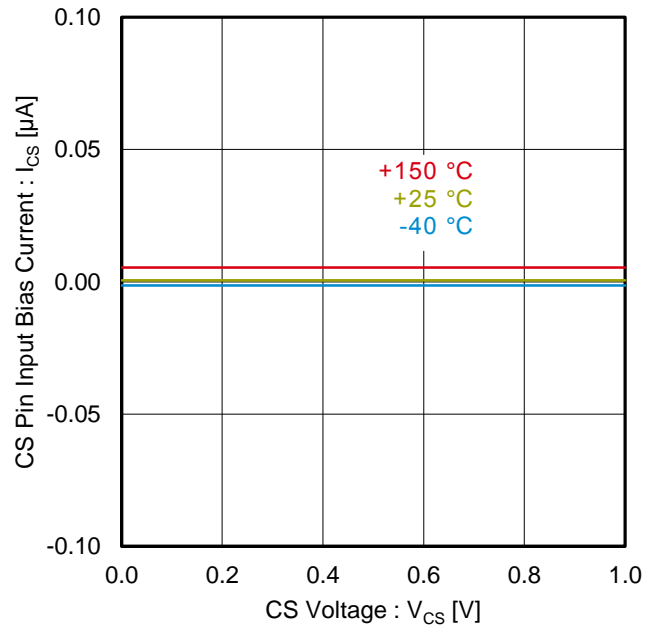

Figure 35. CS Pin Input Bias Current vs CS Voltage

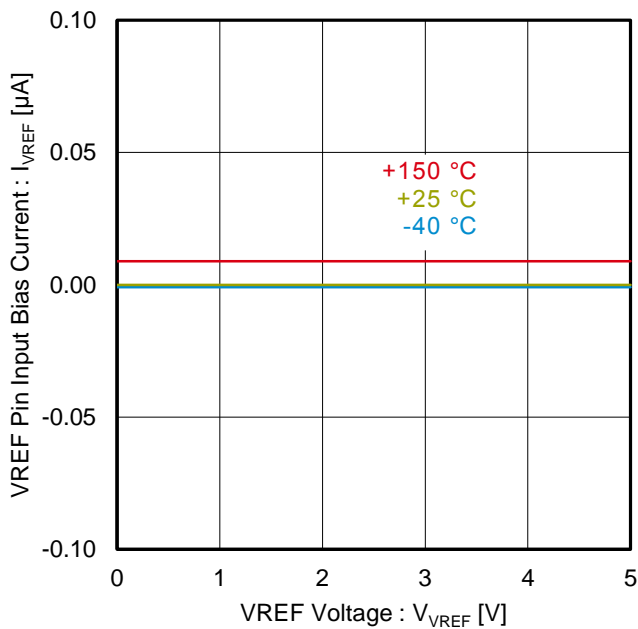

Figure 36. VREF Pin Input Bias Current vs VREF Voltage

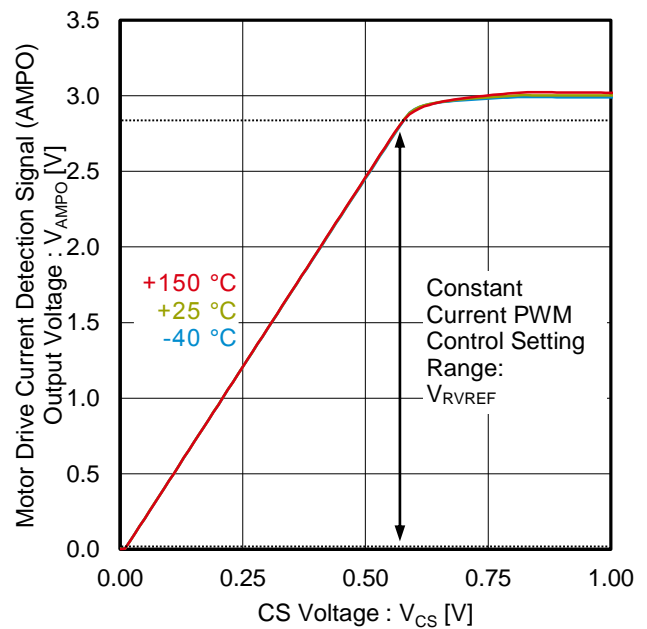

Figure 37. Motor Drive Current Detection Signal (AMPO) Output Voltage vs CS Voltage
(Motor Drive Current Setting Input Voltage Range (Constant Current PWM Control Setting Range))

Typical Performance Curves - continued
(Reference Data)

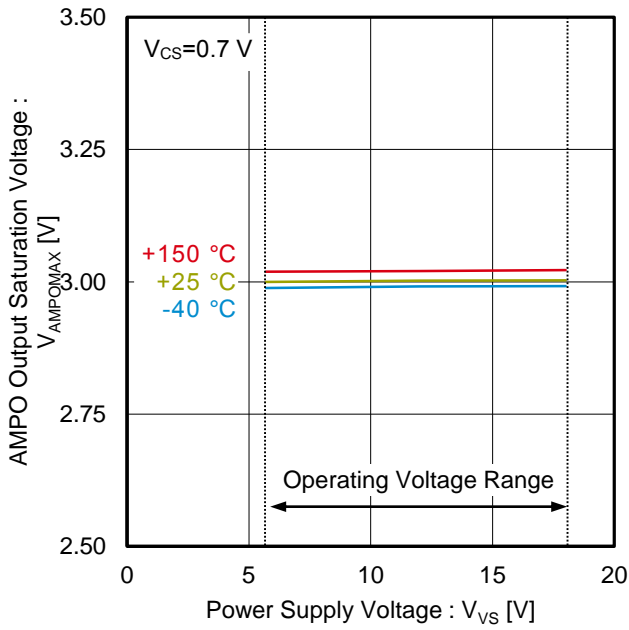

Figure 38. AMPO Output Saturation Voltage vs Power Supply Voltage

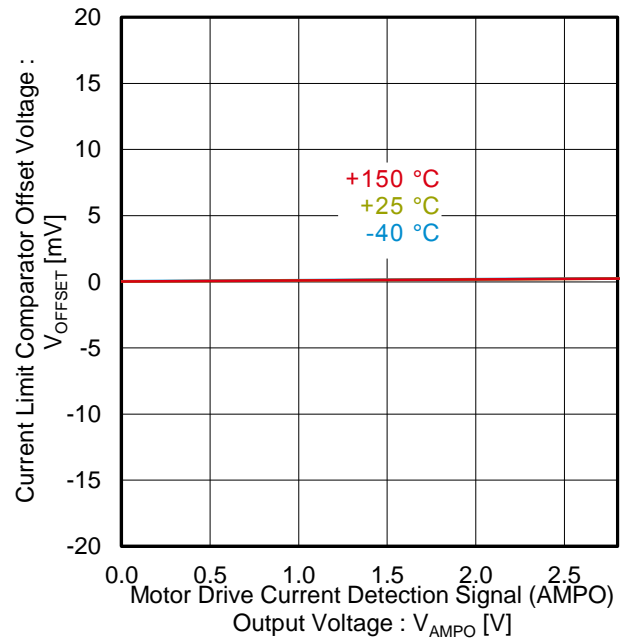

Figure 39. Current Limit Comparator Offset Voltage vs Motor Drive Current Detection Signal (AMPO) Output Voltage

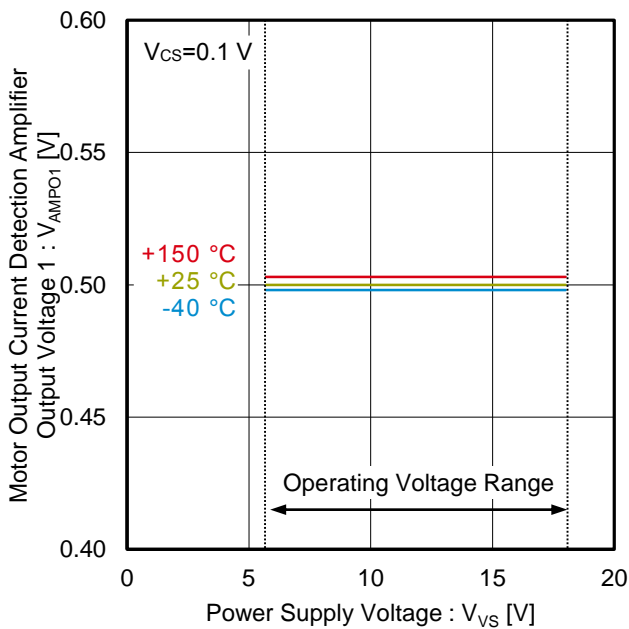

Figure 40. Motor Output Current Detection Amplifier Output Voltage 1 vs Power Supply Voltage

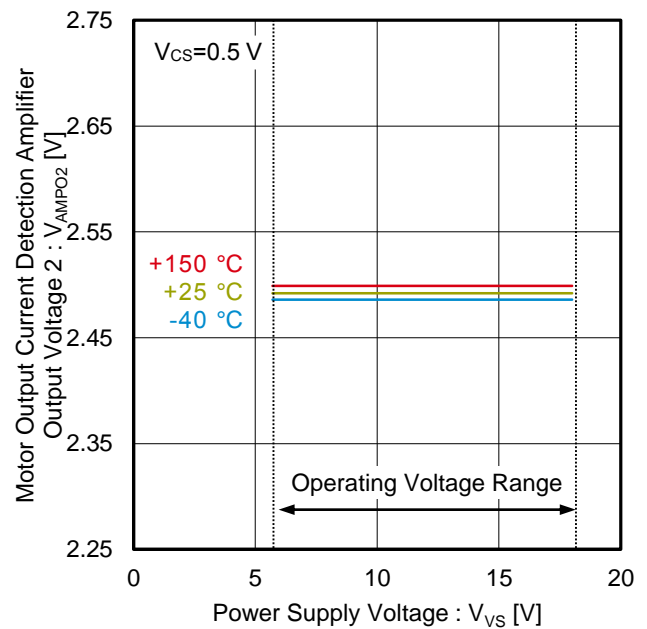

Figure 41. Motor Output Current Detection Amplifier Output Voltage 2 vs Power Supply Voltage

Typical Performance Curves - continued
(Reference Data)

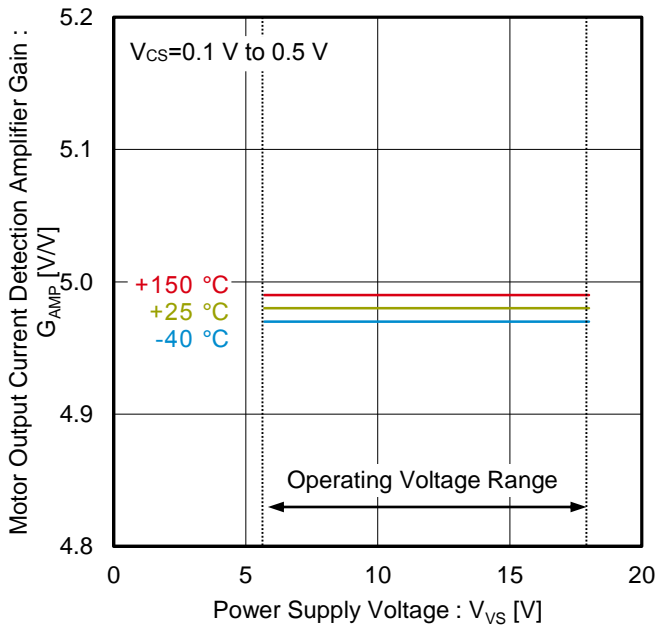

Figure 42. Motor Output Current Detection Amplifier Gain vs Power Supply Voltage

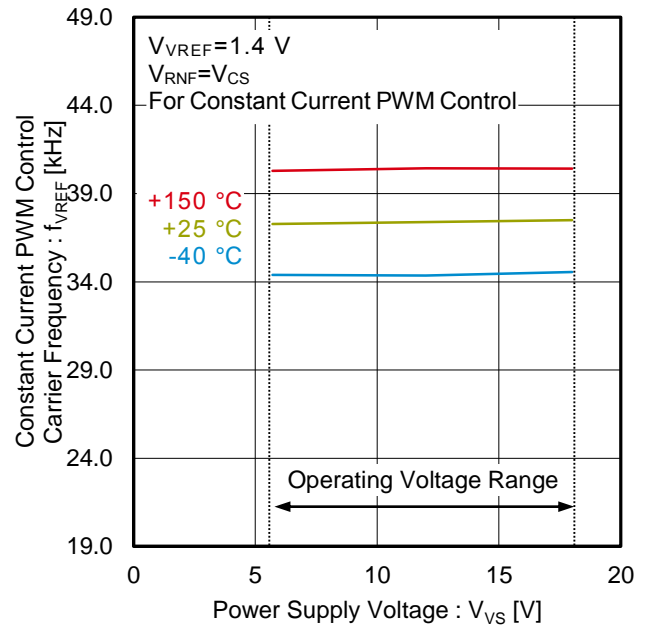

Figure 43. Constant Current PWM Control Carrier Frequency vs Power Supply Voltage

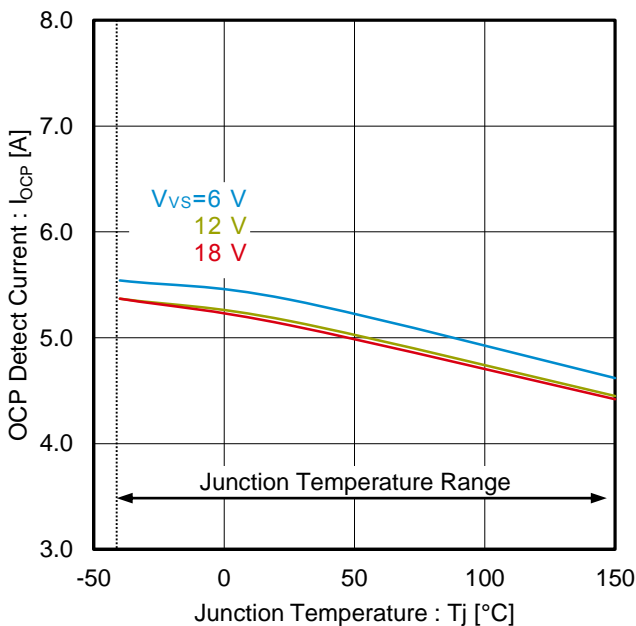

Figure 44. OCP Detect Current vs Junction Temperature (OUT+ High Side)

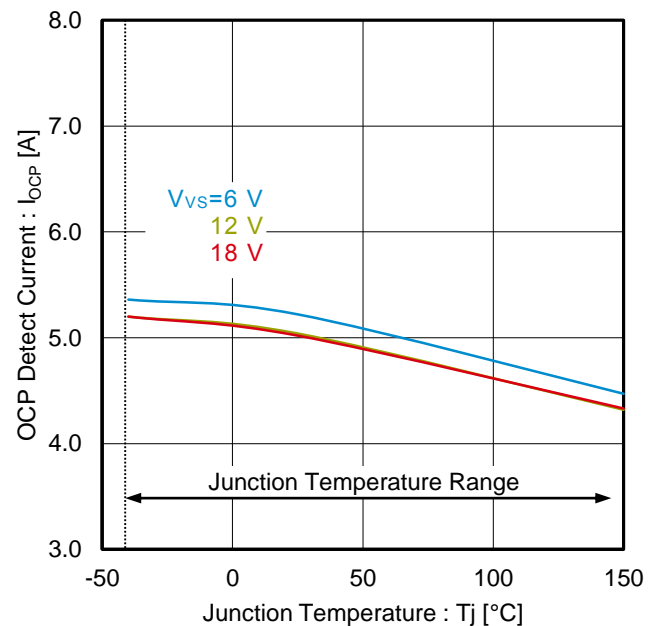

Figure 45. OCP Detect Current vs Junction Temperature (OUT- High Side)

Typical Performance Curves - continued
(Reference Data)

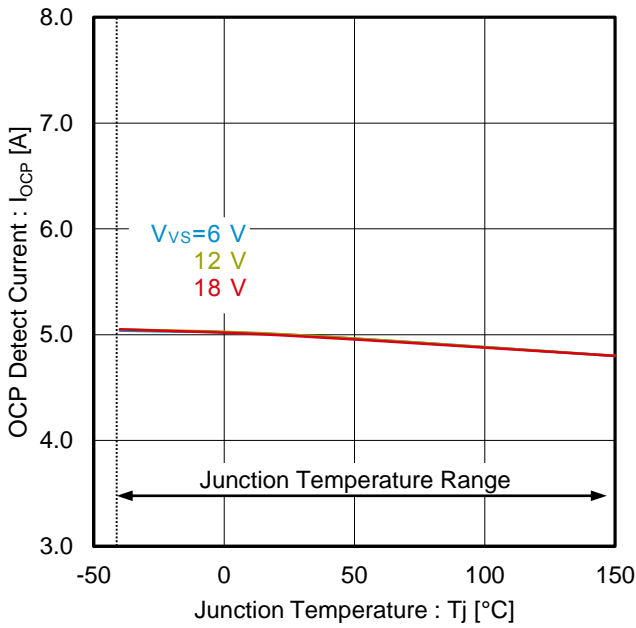

Figure 46. OCP Detect Current vs Junction Temperature (OUT+ Low Side)

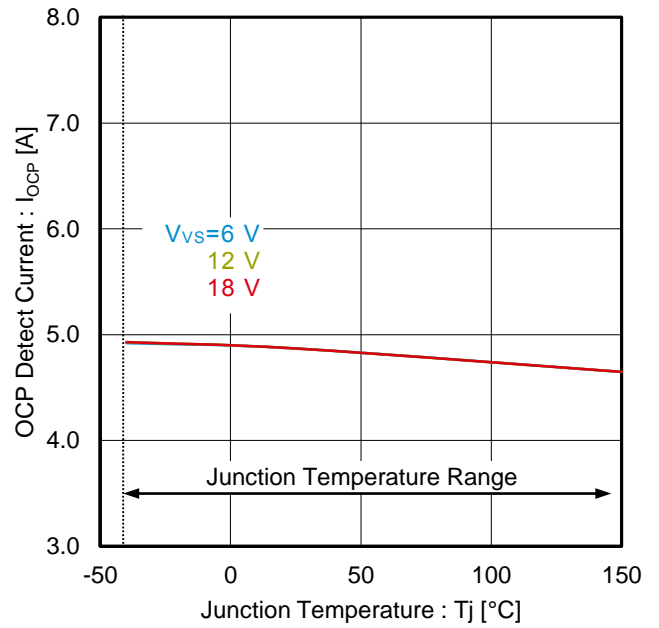

Figure 47. OCP Detect Current vs Junction Temperature (OUT- Low Side)

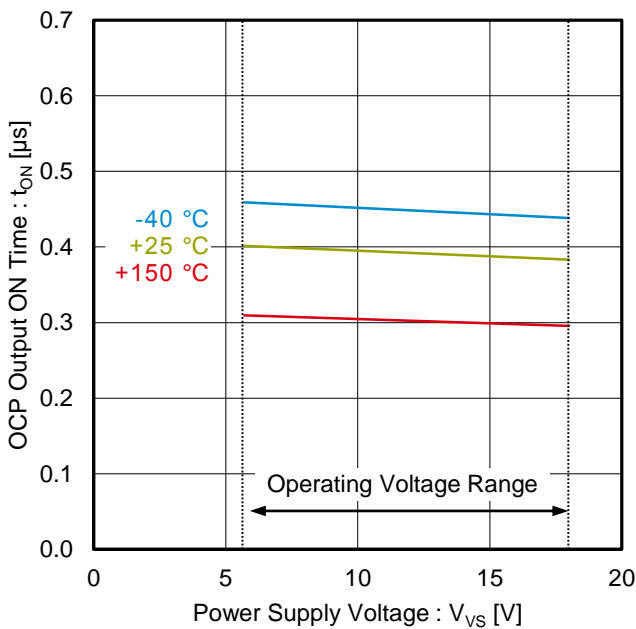

Figure 48. OCP Output ON Time vs Power Supply Voltage

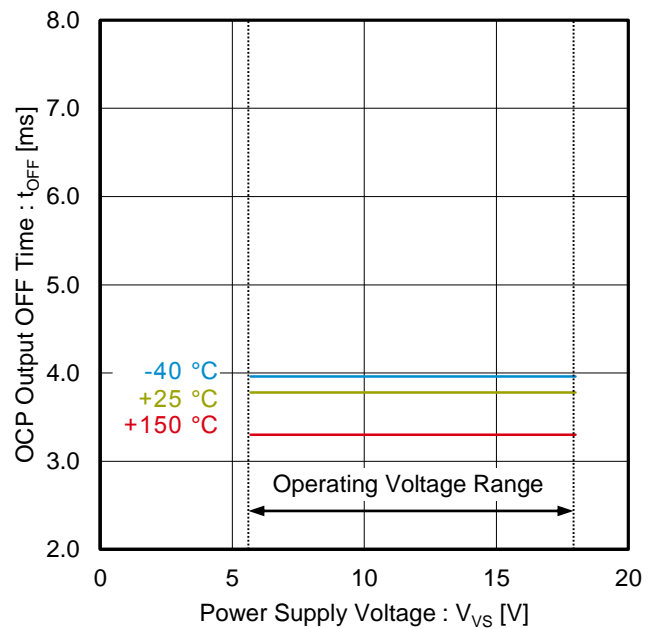

Figure 49. OCP Output OFF Time vs Power Supply Voltage

Typical Performance Curves - continued
(Reference Data)

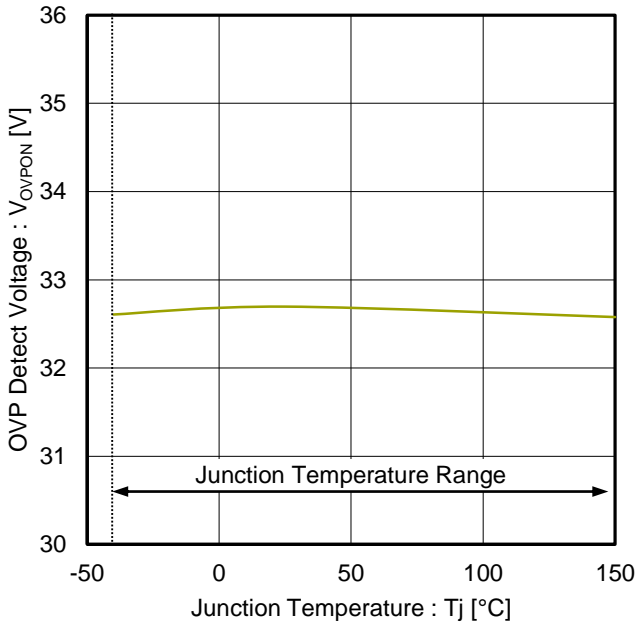

Figure 50. OVP Detect Voltage vs Junction Temperature

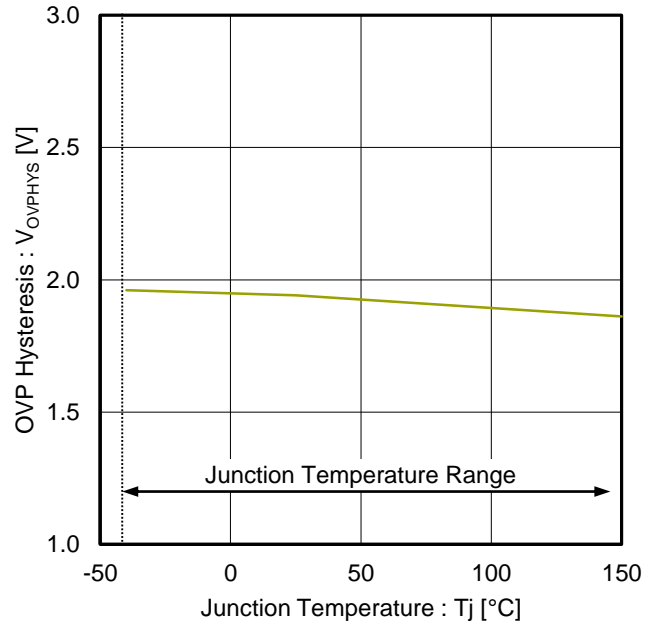

Figure 51. OVP Hysteresis vs Junction Temperature

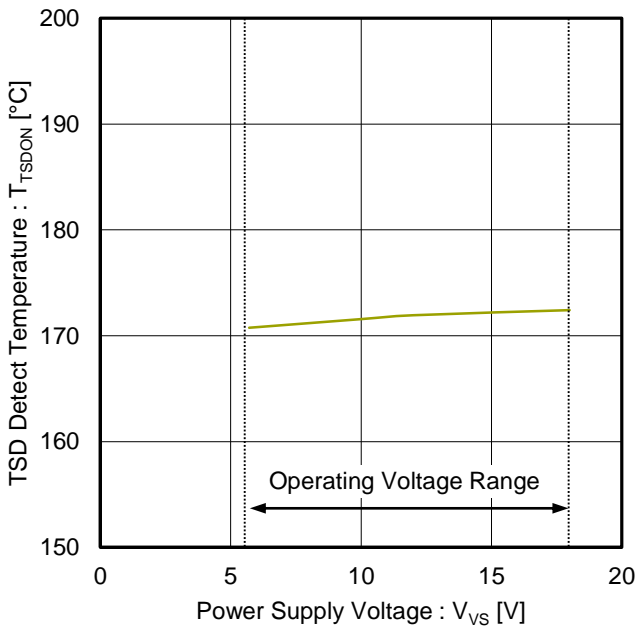

Figure 52. TSD Detect Temperature vs Power Supply Voltage

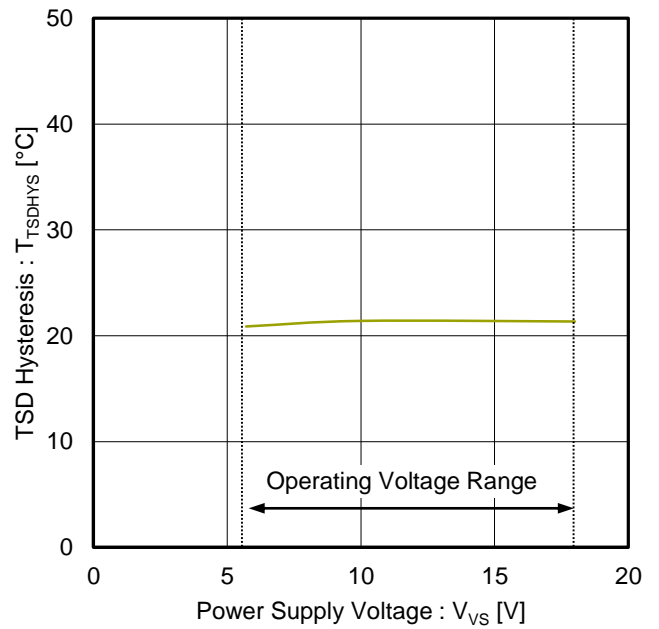

Figure 53. TSD Hysteresis vs Power Supply Voltage

Typical Performance Curves - continued
(Reference Data)

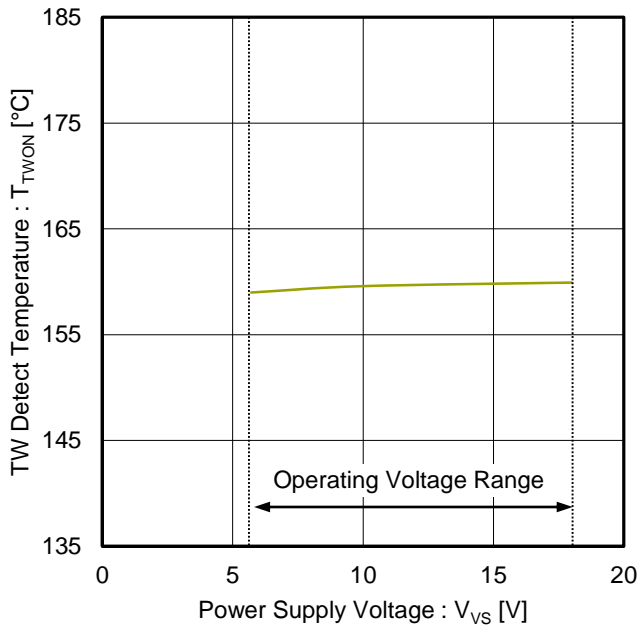

Figure 54. TW Detect Temperature vs Power Supply Voltage

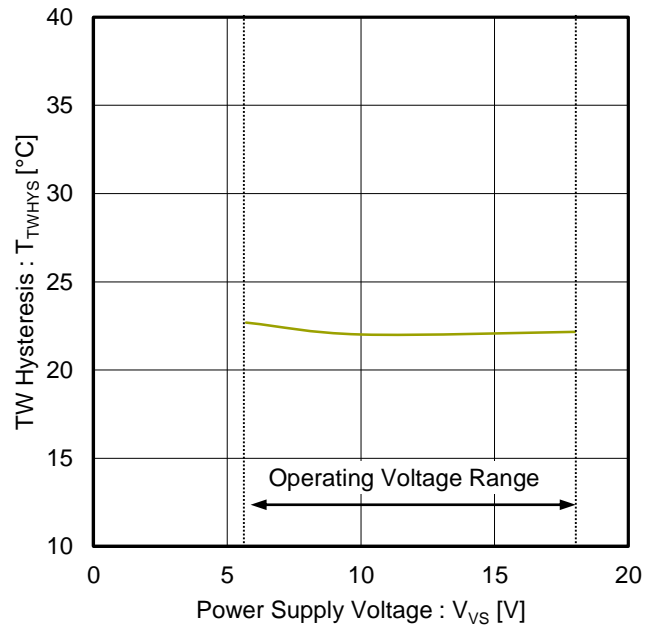

Figure 55. TW Hysteresis vs Power Supply Voltage

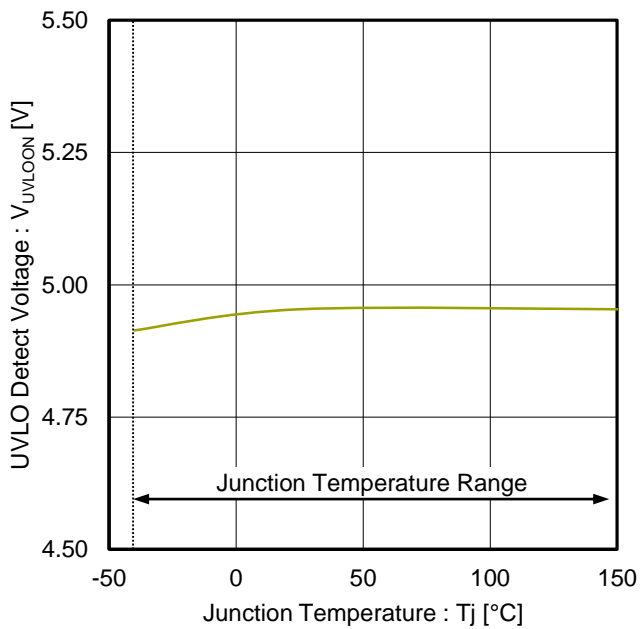

Figure 56. UVLO Detect Voltage vs Junction Temperature

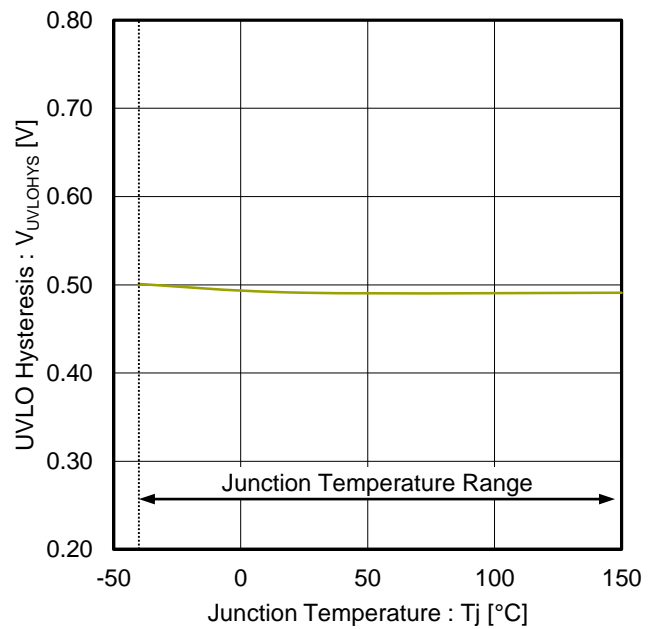

Figure 57. UVLO Hysteresis vs Junction Temperature

Typical Performance Curves - continued
(Reference Data)

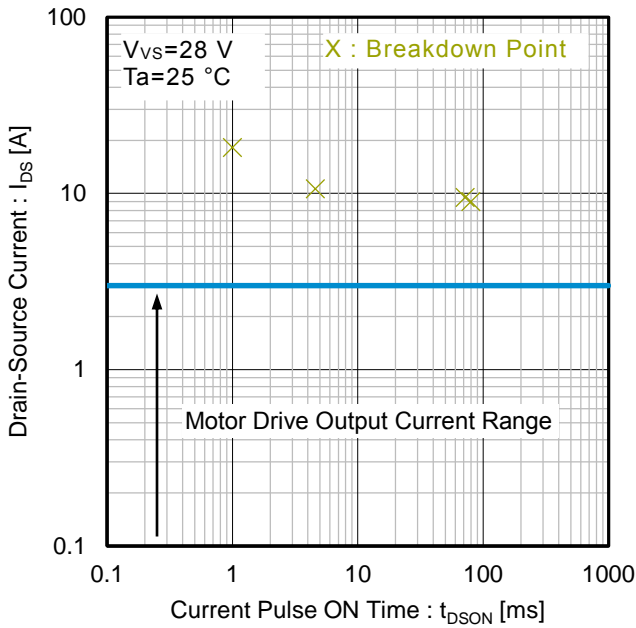

Figure 58. Drain-Source Current vs Current Pulse ON Time (Motor Drive Output Channel Operating Limit, Output High State, OUT+ Higher MOS)

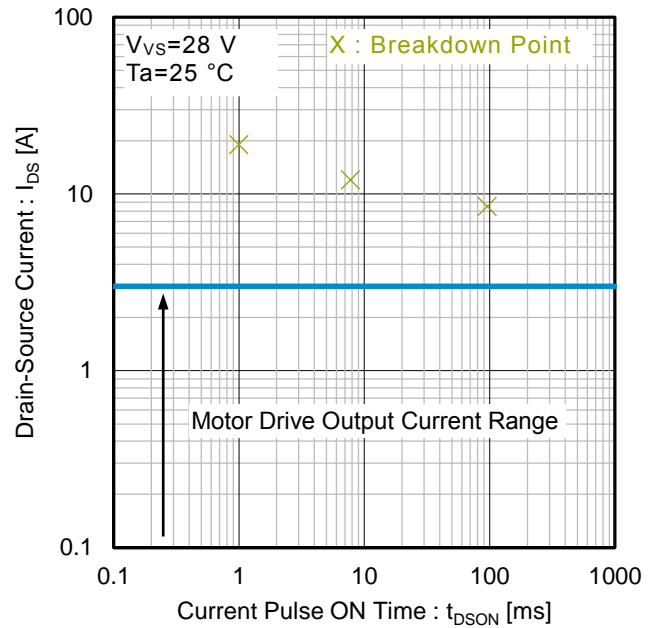

Figure 59. Drain-Source Current vs Current Pulse ON Time (Motor Drive Output Channel Operating Limit, Output High State, OUT- Higher MOS)

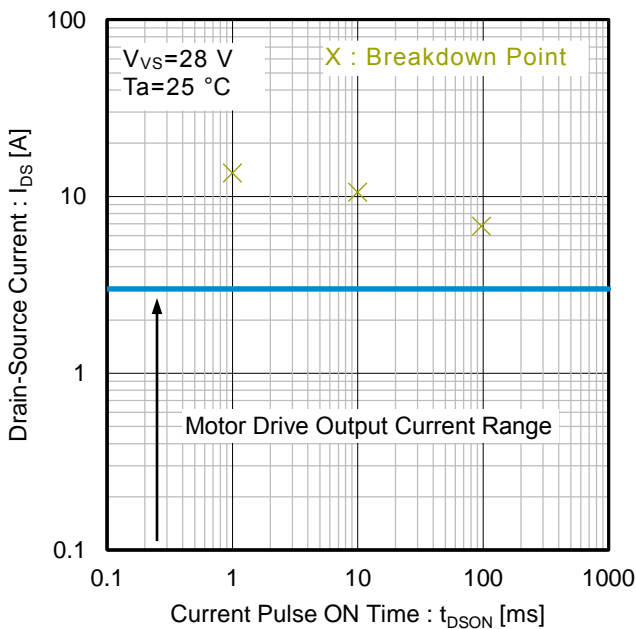

Figure 60. Drain-Source Current vs Current Pulse ON Time (Motor Drive Output Channel Operating Limit, Output Low State, OUT+ Lower MOS)

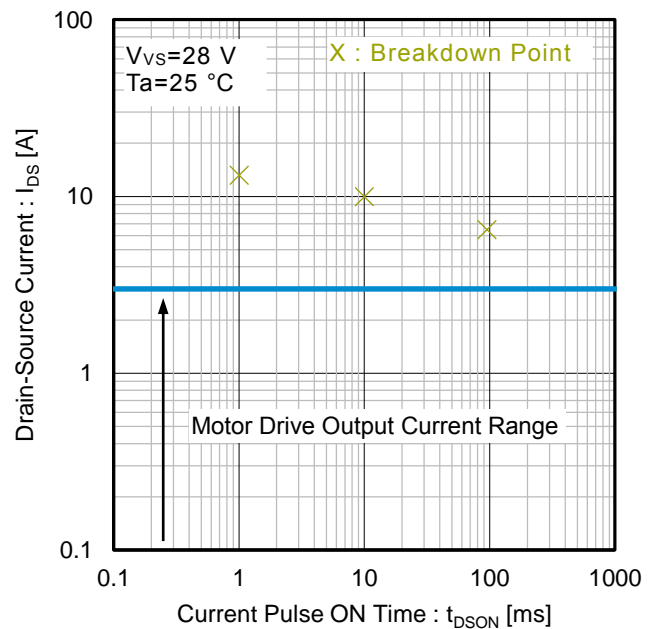

Figure 61. Drain-Source Current vs Current Pulse ON Time (Motor Drive Output Channel Operating Limit, Output Low State, OUT- Lower MOS)

Typical Performance Curves - continued
(Reference Data)

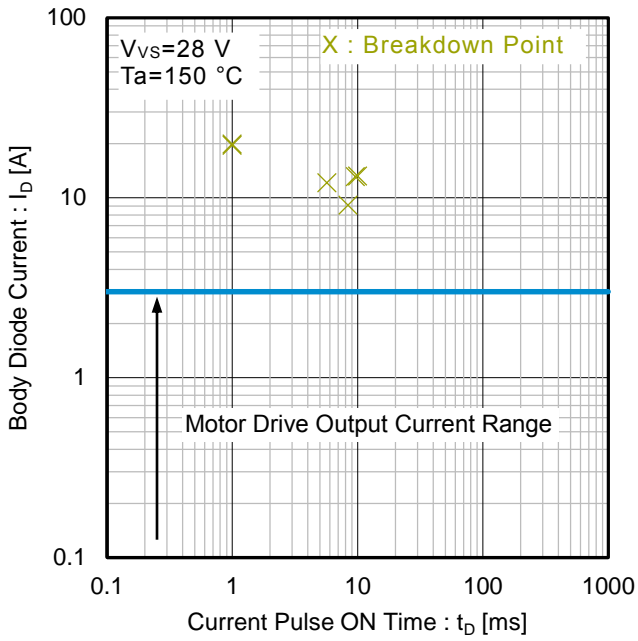

Figure 62. Body Diode Current vs Current Pulse ON Time
(Motor Drive Output Body Diode Operating Limit,
Output Hi-Z State, OUT+, OUT- Higher MOS)

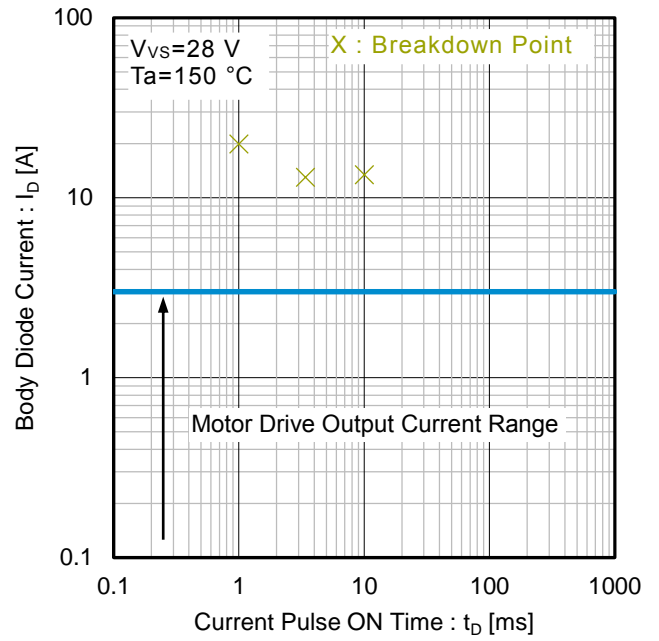

Figure 63. Body Diode Current vs Current Pulse ON Time
(Motor Drive Output Body Diode Operating Limit,
Output Hi-Z State, OUT+, OUT- Lower MOS)

Application Example

(External components can be used if necessary. Refer to the below values.)

1. Variable Speed Control Application by Direct PWM Control.

This is an application circuit example that directly PWM controls the motor drive output by the PWM duty input to the motor drive logic input pin (IN+, IN-) and varies the motor rotation speed.

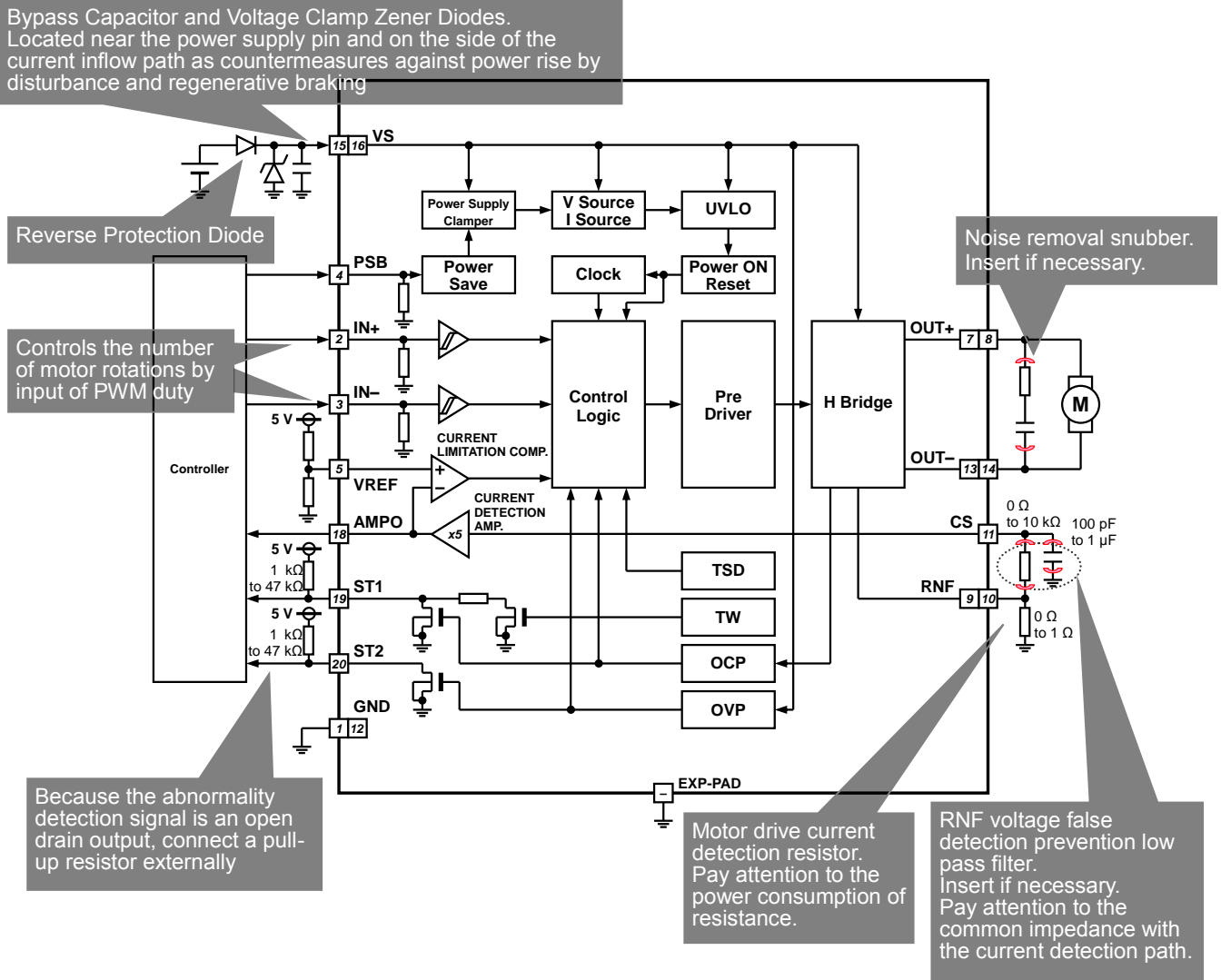

Figure 64. Direct PWM Control Application Circuit

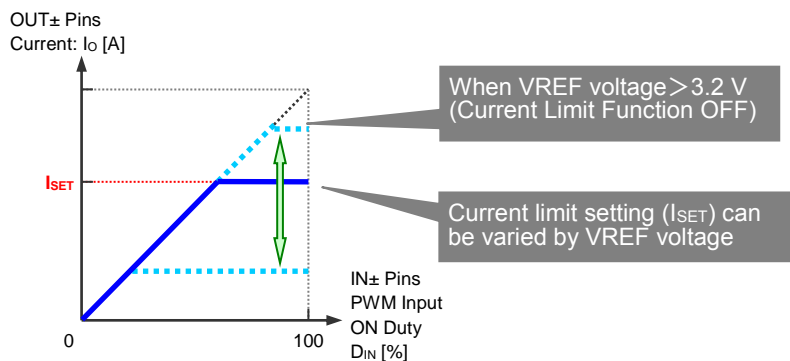

Figure 65. OUT± Pins Current vs VREF Pin Input Voltage Characteristic Image

Application Example - continued

(External components can be used if necessary. Refer to the below values.)

2. Variable Speed Control Application by Constant Current PWM Control

This is an application circuit example in which the motor drive output is subjected to constant current PWM control depending on the DC voltage that is input to the motor drive current setting voltage input pin (VREF), and varies the motor rotation speed.

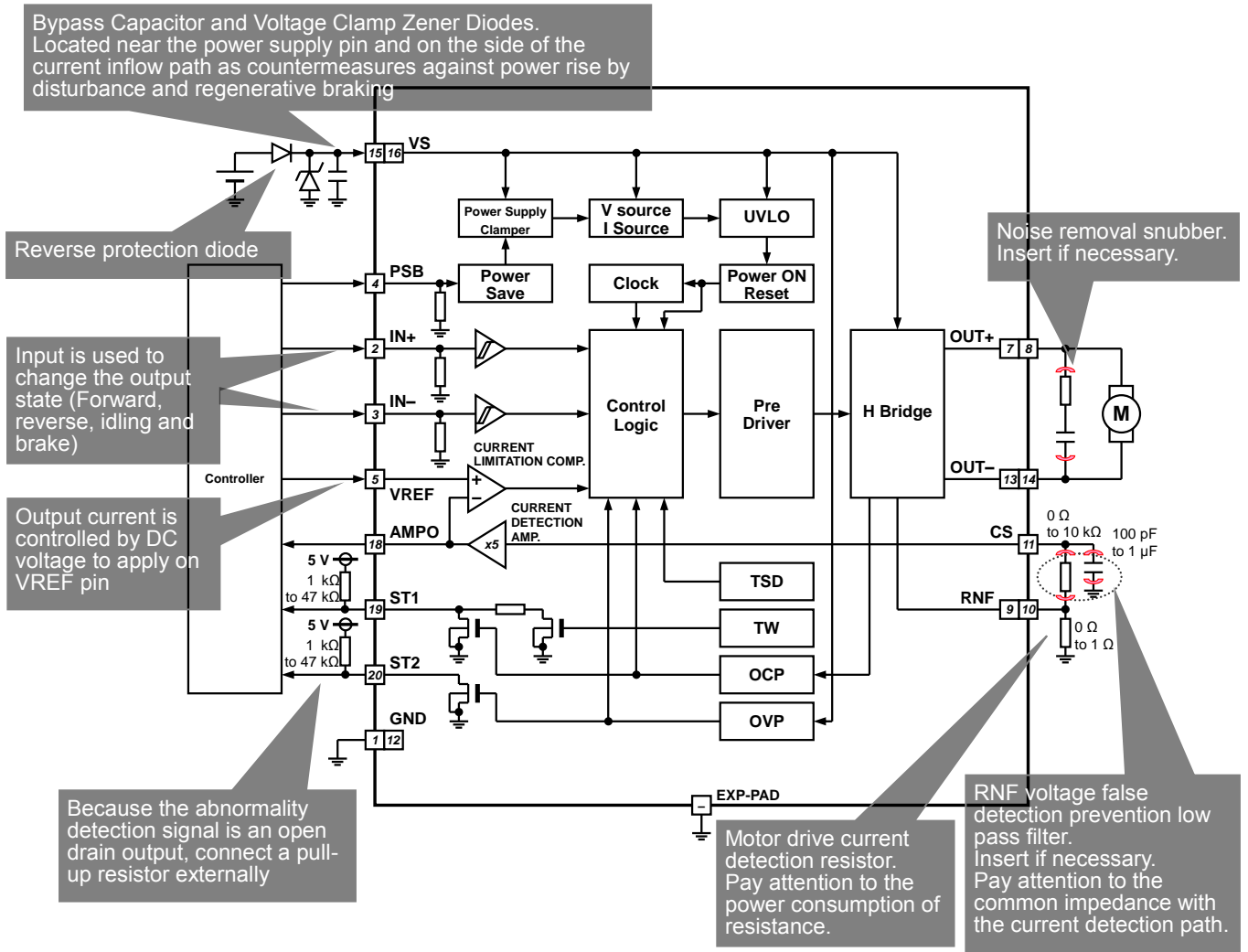

Figure 66. Constant Current PWM Control Application Circuit

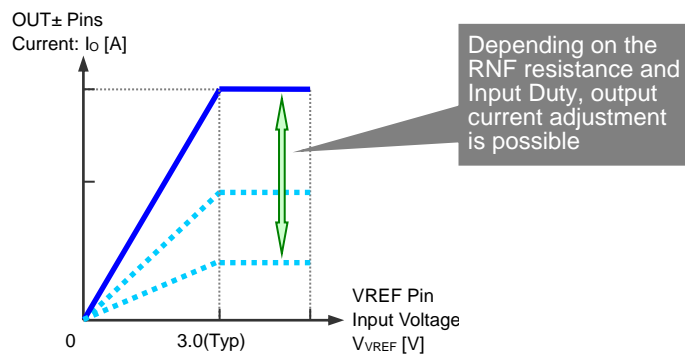

Figure 67. VREF Pin Input Voltage vs OUT± Pins Current Characteristic Image

Description of Blocks

1. Under Voltage Lock Out: UVLO.

When the voltage applied to the VS pin becomes 5.0 V (Typ) or less, the driver output becomes Hi-Z. It returns when the voltage applied to the VS pin becomes 5.5 V (Typ) or more. UVLO function, and Abnormality Detection Signal Output ST1 and ST2 are not linked.

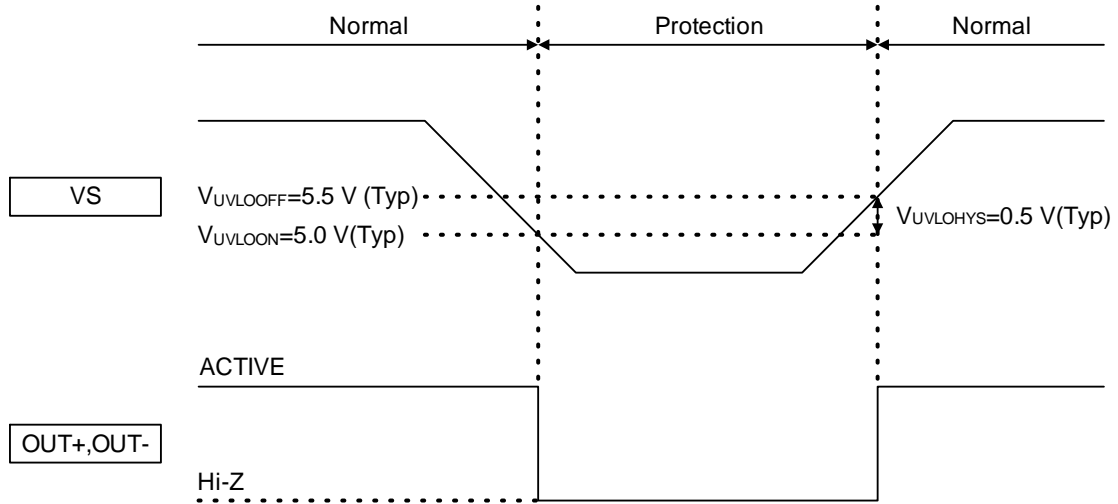

Figure 68. UVLO Timing Chart

2. Over Voltage Protection: OVP

When the voltage applied to the VS pin becomes 33 V (Typ) or more, the driver output and the ST2 output becomes Low.

If the driver output is HI-Z during this state, output remains at HI-Z. It returns when the voltage applied to the VS pin becomes 31 V (Typ) or less.

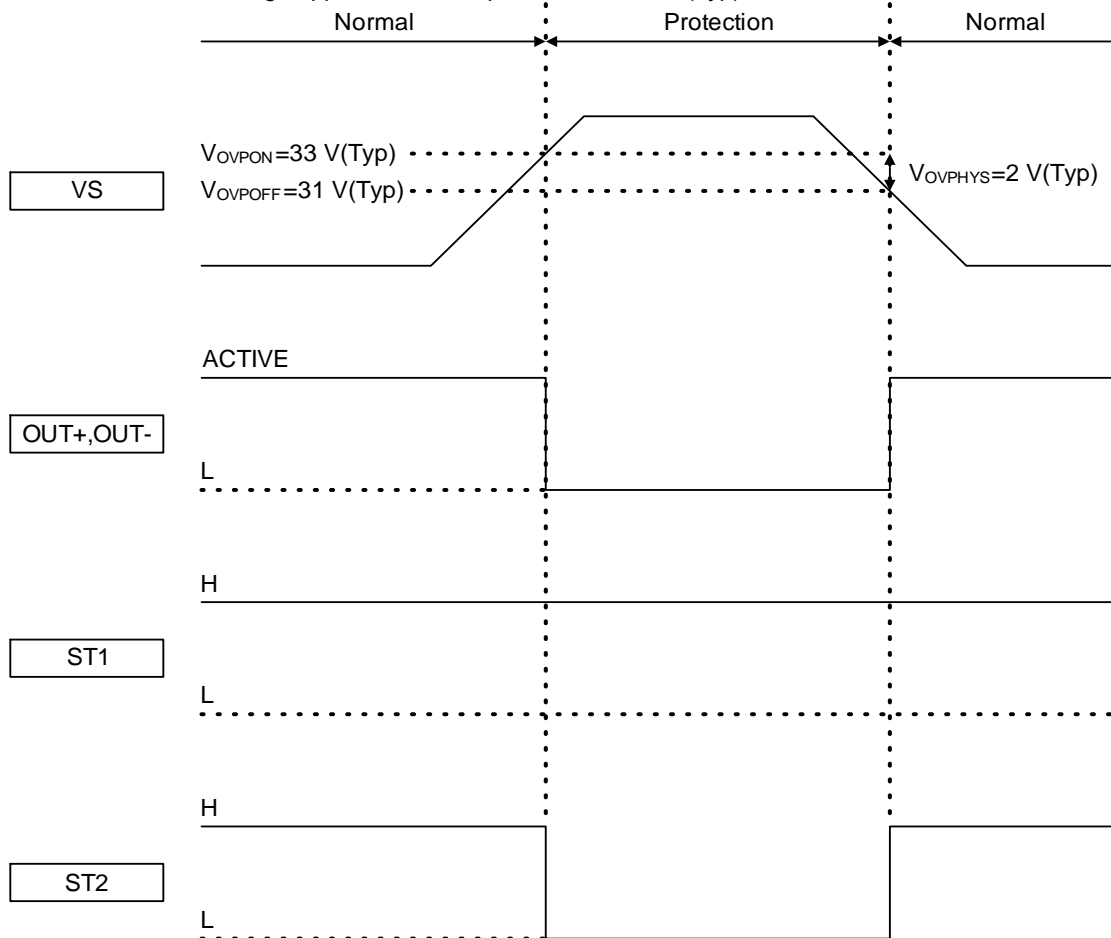

Figure 69. OVP Timing Chart

Description of Blocks - continued

3. Over Current Protection: OCP

When the output current exceeds the rated current, OCP is detected at OUT+/OUT- pins, higher/lower sides respectively and both the driver outputs (OUT+/OUT-) go to Hi-Z at the same time. The driver output turns ON for $t_{ON}=0.4 \mu s$ (Typ) or more and turns OFF for $t_{OFF}=4 ms$ (Typ).

If overcurrent state is continued, Hi-Z is repeated again. Also, when overcurrent is detected, ST1 goes low and retains low while the overcurrent continues.

ST1 goes high after $t_{MASK}=1 ms$ (Typ) once recovering from overcurrent.

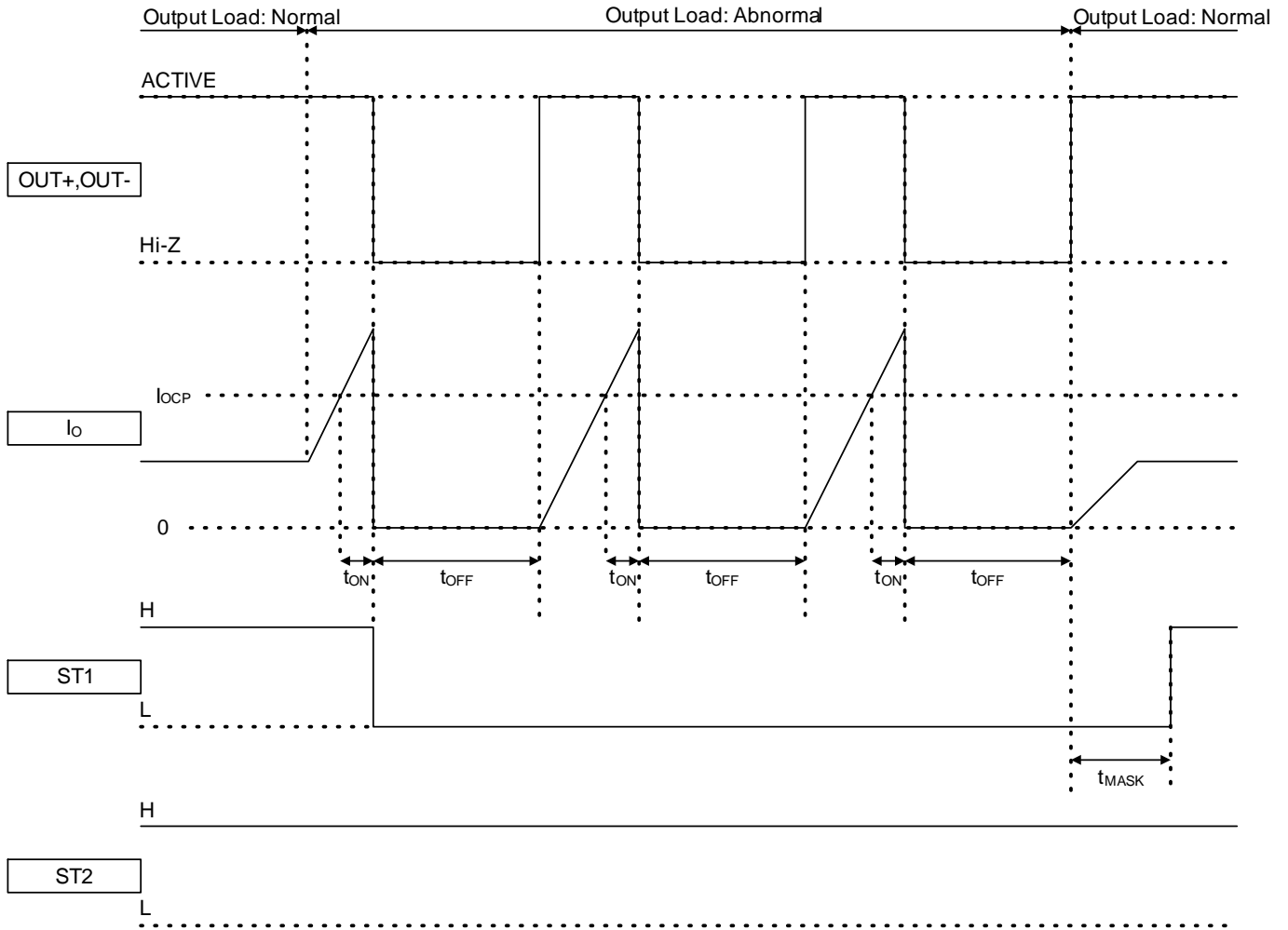

Figure 70. OCP Timing Chart

Description of Blocks - continued

4. Thermal Warning: TW, Thermal Shutdown: TSD

To prevent IC from thermal destruction, thermal warning and thermal shutdown are built-in.

Make sure that the junction temperature T_j is 150 °C and below, but if that is crossed by any possibility, and the junction temperature reaches 160 °C (Typ) or higher, the thermal warning is in operation and ST1 pin voltage V_{ST1} depends on the pull up resistance value.

The formula is as follows.

$$V_{ST1} = \frac{R_{ST1}}{R_{ST1} + R_{PULLUP}} V_{PULLUP} [V]$$

where:

V_{PULLUP} is ST1 pin resistance pull up power supply voltage.

R_{PULLUP} is ST1 pin pull up resistance value.

R_{ST1} is ST1 pin internal impedance for thermal warning.

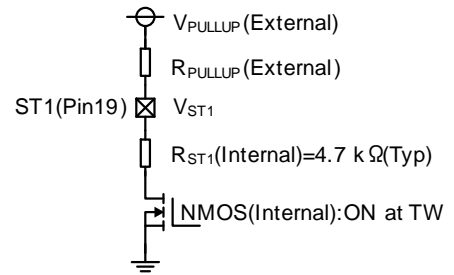

Figure 71. ST1 Pin Circuit for TW

R_{ST1} is 4.7 kΩ (Typ).

If $V_{PULLUP}=5V$ for example, $V_{ST1}=2.5 V$ (Middle) for $R_{PULLUP}=4.7 k\Omega$, $V_{ST1}=0.45 V$ (Low) for $R_{PULLUP}=47 k\Omega$.

When the junction temperature further rises to 175 °C (Typ) or more, TSD is in operation and sets the driver output to Hi-Z. After that, when the temperature reaches 150 °C (Typ) or less, the driver output returns, and when the temperature reaches 135 °C (Typ) or less, ST1 also returns.

Note: While the thermal warning and thermal shutdown is in operation, ST1 goes the above voltage V_{ST1} , but since it is in the state exceeding the rated temperature, there is a possibility that the state of ST1 and other functions cannot be retained.

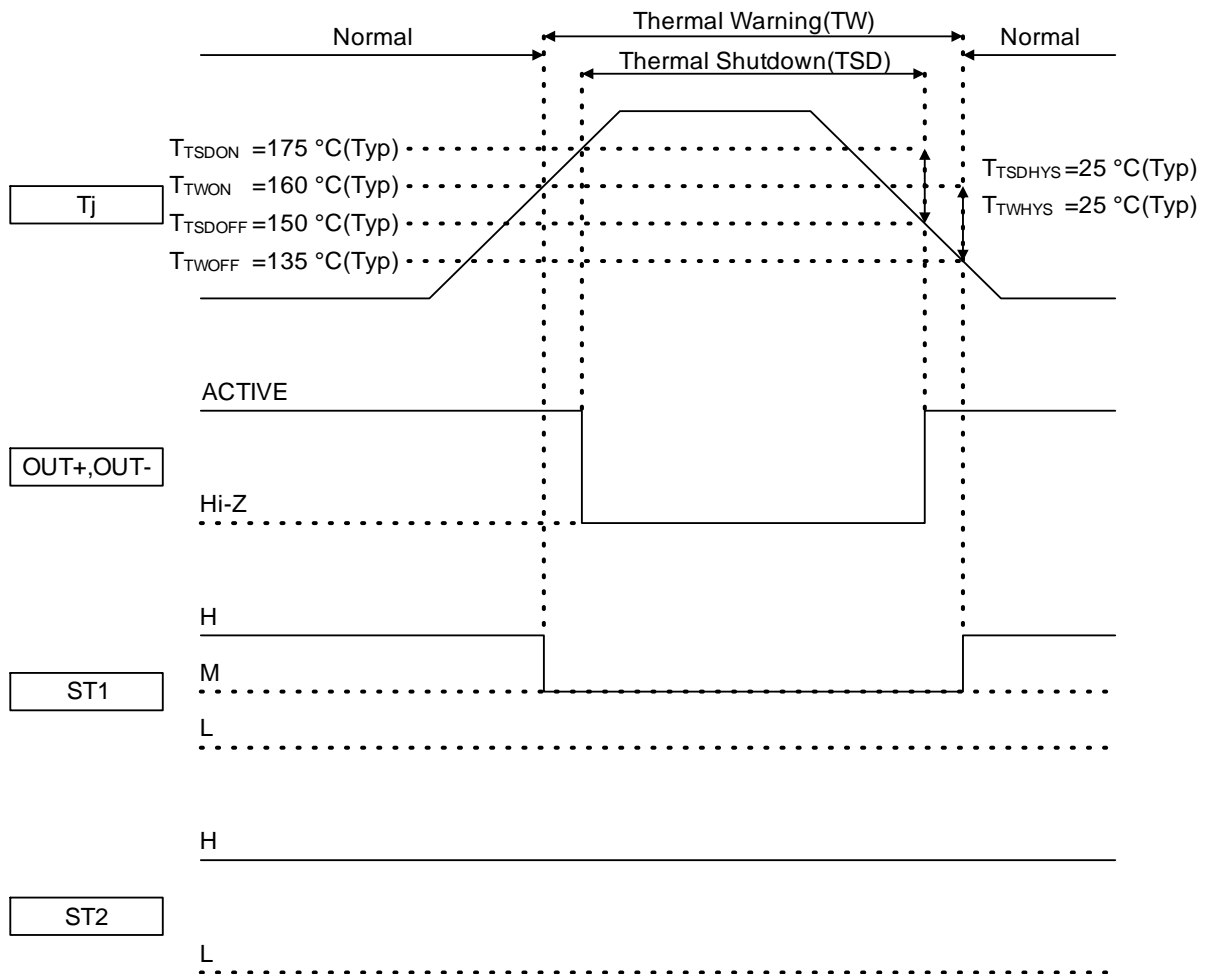

Figure 72 TW, TSD Timing Chart

Description of Blocks - continued

5. Direct PWM Control

Direct PWM control by IN+ and IN- pins is possible.

There is no restriction to input for pin switching order of PSB, IN+ and IN-.

Regarding the DECAY mode, it supports both SLOW DECAY and FAST DECAY modes.

Because of RNF pin voltage and the output pin voltage may swing to GND or less at the FAST DECAY status, set within the absolute maximum ratings.

SLOW DECAY (Forward Rotation)

	Driver Input			Driver Output		State
	PSB	IN+	IN-	OUT+	OUT-	
↓	H	H	L	H	L	ON
	H	H	H	L	L	SLOW DECAY
	H	H	L	H	L	ON
	H	H	H	L	L	SLOW DECAY
	H	H	L	H	L	ON

FAST DECAY (Synchronous Rectification, Forward Rotation)

	Driver Input			Driver Output		State
	PSB	IN+	IN-	OUT+	OUT-	
↓	H	H	L	H	L	ON
	H	L	H	L	H	FAST DECAY
	H	H	L	H	L	ON
	H	L	H	L	H	FAST DECAY
	H	H	L	H	L	ON

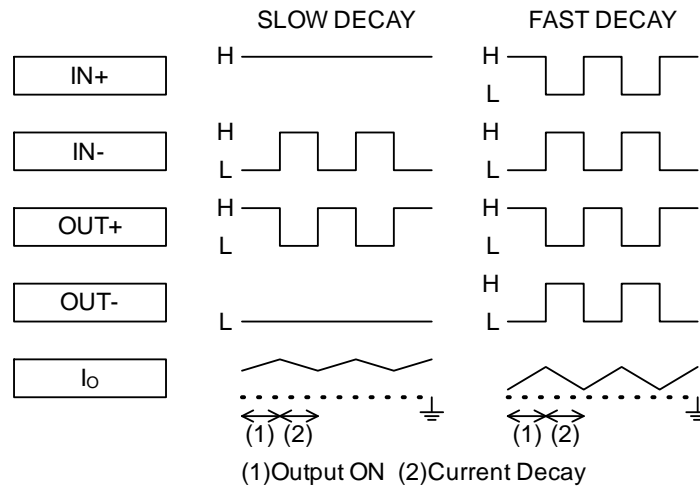

Figure 73. I/O Waveform of Each DECAY Mode

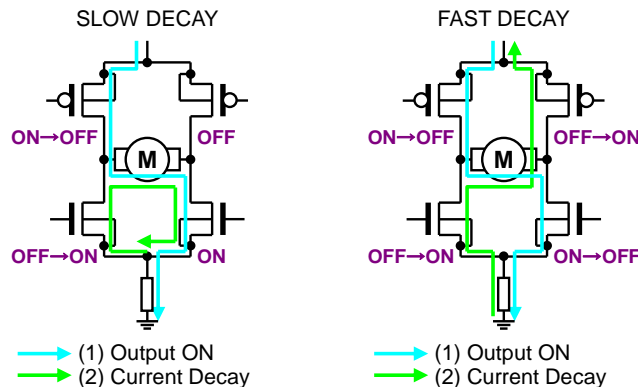

Figure 74. Current Path of Each DECAY Mode

Description of Blocks - continued

6. Output Current Detection Amp (AMPO Pin)

The AMPO pin outputs $G_{AMP}=5$ times (Typ) of the CS pin voltage with reference to the ground voltage.

For example, $V_{AMPO}=0.5$ V (Typ) for $V_{CS}=0.1$ V.

By connecting the current detection resistor R_{RNF} to the RNF pin and connecting it with the CS pin, the AMPO pin voltage can be used for output current monitoring.

In the case that this function is not used, set the AMPO pin to OPEN.

The AMPO pin has the circuit to limit the output voltage internally. The limit voltage is $V_{AMPOMAX}$ is 3 V (Typ).

When the AMPO pin voltage exceeds 3.6 V, the test mode function for Mass Production check is enabled and the driver output is set to Hi-Z. Do not exceed the pin rated 3.6 V and add a capacitor between AMPO pin and GND if necessary to smooth AMPO pin voltage. In case of that AMPO pin has 25 kΩ (Typ) resistance as output impedance internally and there will be delay due to additional capacitor and time constant of internal resistance. Note: The delay has effect on constant current PWM control.

In the case of constant current PWM control and the output current detection amplifier not being used together, set the VREF pin to be 3.2 V or higher and 7 V or lower, and connect the RNF pin and CS pin to the ground.

7. Constant Current PWM Control (Current Limit)

Constant current PWM control with VREF pin is possible.

The motor drive current I_{SET} can be set by the VREF pin voltage V_{VREF} , the current detection resistor R_{RNF} connected to the RNF pin, and the current detection amplifier gain G_{AMP} .

The relation between I_{SET} , V_{VREF} , R_{RNF} and G_{AMP} is given below.

$$I_{SET} = \frac{V_{VREF}}{G_{AMP} \times R_{RNF}} \text{ [A]}$$

The constant current PWM control setting range of VREF pin V_{RVREF} is 0 V to 2.8 V and it is the output range for PWM. If I_{SET} tends to 0, percentage error of I_O with I_{SET} increases. Consider the below following characteristic and use in the appropriate range according to applications. However, this reference characteristic isn't guaranteed value but evaluation value.

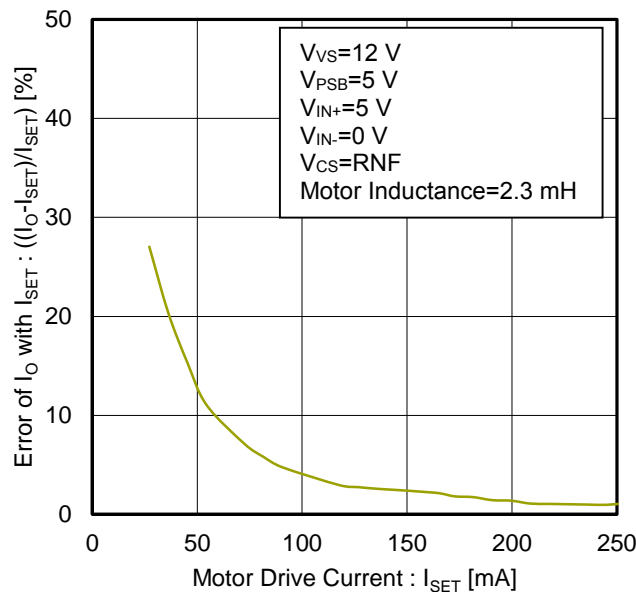

Figure 75. Error of I_O with I_{SET} $((I_O - I_{SET}) / I_{SET})$ vs Motor Drive Current I_{SET} (Reference Data)

The voltage generated at the RNF pin is detected from the CS pin. If necessary, a low-pass filter can be added between the RNF pin and the CS pin to smooth the RNF pin voltage fluctuation.

Carrier frequency is 33 kHz (Typ).

In the case of constant current PWM control and the output current detection amplifier not being used together, set the VREF pin to be 3.2 V or higher and 7 V or lower, and connect the RNF pin and CS pin to the ground.

7. Constant Current PWM Control (Current Limit) - continued

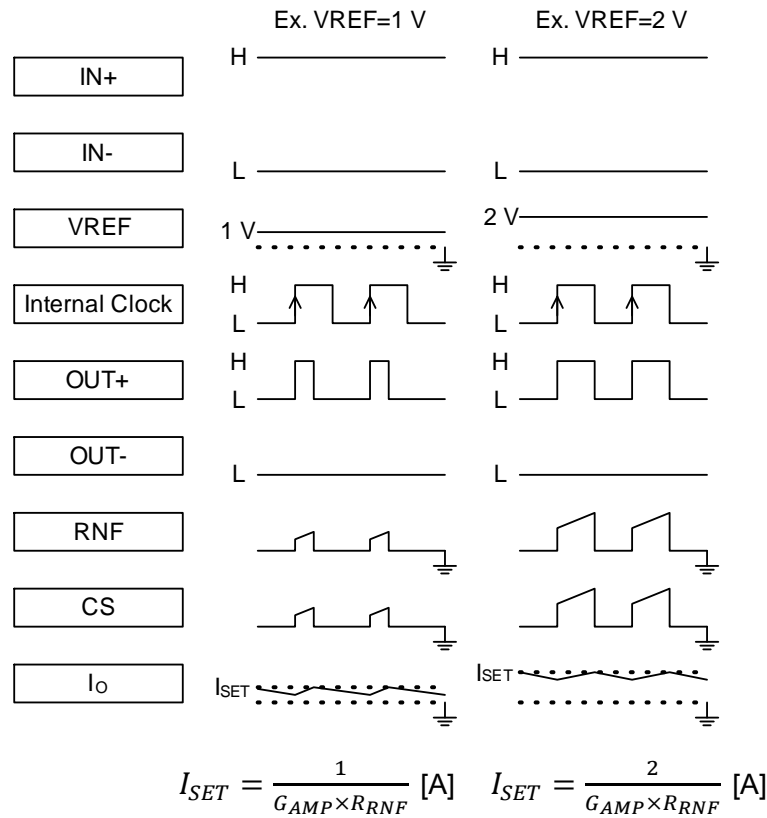

Figure 76. I/O Waveform during Constant Current PWM Control

8. Power Save (PSB Pin)

IC internal circuits can be used as power saved state and power consumption can be reduced by lowering PSB pin voltage. Driver output goes Hi-Z at the time. Refer I/O truth table for details of other pin state. There is no restriction to input for pin switching order of PSB, IN+ and IN-.

I / O Equivalence Circuits (Resistance Values are Typical)

<p style="text-align: center;">2.IN+, 3.IN-</p>	<p style="text-align: center;">4.PSB</p>
<p style="text-align: center;">5.VREF</p>	<p style="text-align: center;">7,8.OUT+, 9,10.RNF, 13,14.OUT-</p>
<p style="text-align: center;">11.CS</p>	<p style="text-align: center;">15,16.VS</p>
<p style="text-align: center;">18.AMPO</p>	<p style="text-align: center;">19.ST1</p>
<p style="text-align: center;">20.ST2</p>	<p style="text-align: center;">-</p>

Heat Loss

1. Thermal Resistance

The heat generated by the consumption of power by the IC is dissipated from the mold resin of the package or the lead frame etc.

The parameter indicating the heat dissipation property (heat dissipation difficulty) is called thermal resistance, and the thermal resistance from the chip junction to the ambient environment in the board mounted state is represented by θ_{ja} [$^{\circ}\text{C}/\text{W}$], and the thermal characteristic parameter from the chip junction to top surface center of package is expressed as ψ_{jt} [$^{\circ}\text{C}/\text{W}$].

The thermal resistance is divided into the package part and the substrate part, the thermal resistance of the package part depends on the constituent material such as the mold resin or the lead frame etc., on the other hand, the thermal resistance of the substrate part depends on the substrate heat dissipation properties such as quality of material, size, copper foil area etc.

Therefore, by heat dissipating counter-measures like installing a heat sink on the mounting board, thermal resistance can be reduced.

The thermal resistance model is shown in Figure 77, and the thermal resistance calculation formula is shown in Equation 1, Equation 2 respectively.

$$\theta_{ja} = \frac{T_j - T_a}{P} \quad [^{\circ}\text{C}/\text{W}] \text{ (Equation 1)}$$

$$\psi_{jt} = \frac{T_j - T_t}{P} \quad [^{\circ}\text{C}/\text{W}] \text{ (Equation 2)}$$

θ_{ja} : Thermal Resistance from the Junction to the Ambient Environment [$^{\circ}\text{C}/\text{W}$]

ψ_{jt} : Thermal Characteristic Parameter from the Junction to Top Surface Center of Package [$^{\circ}\text{C}/\text{W}$]

T_j : Junction Temperature [$^{\circ}\text{C}$]

T_a : Ambient Temperature [$^{\circ}\text{C}$]

T_t : Package Surface Temperature [$^{\circ}\text{C}$]

P : Power Consumption [W]

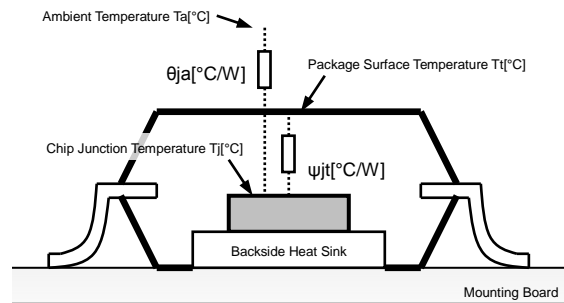

Figure 77. Thermal Resistance Model of Backside Exposed Package with Heat Sink

Thermal resistances θ_{ja} , ψ_{jt} vary depending on the measurement environment such as chip size or power consumption of the mounted IC, and ambient temperature, mounting conditions, wind speed, etc. even if the same package is used.

2. Power Dissipation

Power dissipation (total loss) is the power that the IC can consume at ambient temperature $T_a = 25^{\circ}\text{C}$ (normal temperature). The IC generates heat when it consumes electric power, and the temperature of the IC chip becomes higher than the ambient temperature. The allowable temperature of the IC chip in the package (the junction temperature specified by the absolute maximum rating) is determined by the circuit configuration or the manufacturing process etc. Power dissipation is determined by its maximum junction temperature, thermal resistance in board mounted condition, and ambient temperature.

3. Thermal De-rating Curve

The thermal de-rating curve shows the power (power dissipation) that the IC can consume against the ambient temperature. The power dissipation decays from ambient temperature 25°C , and becomes zero at the maximum junction temperature 150°C . The slope is reduced by the reciprocal of the thermal resistance θ_{ja} .

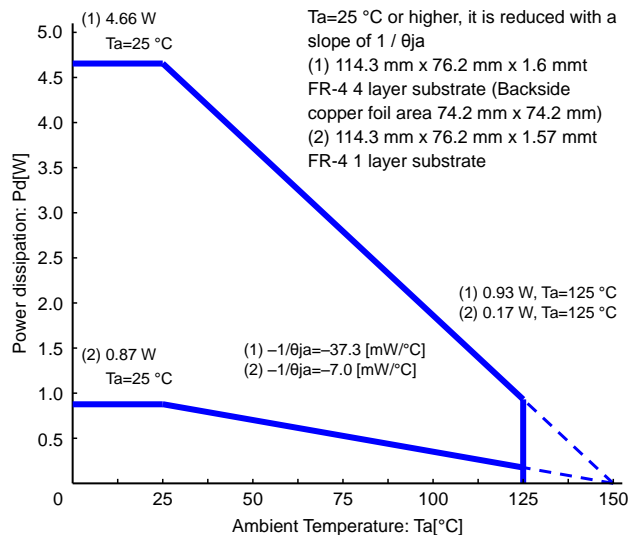

Figure 78. Thermal De-rating Curve by Mounting Board (Reference Value)

Safety Measures

1. Countermeasure against Destruction of Reverse Connection Power Supply
 In reverse connection of the power supply, current flows through a route different from the normal one, which may cause IC breakdown or deterioration. If there is a possibility of reverse connection, it is necessary to insert the reverse connection breakdown prevention diode between power supply and power supply pin.

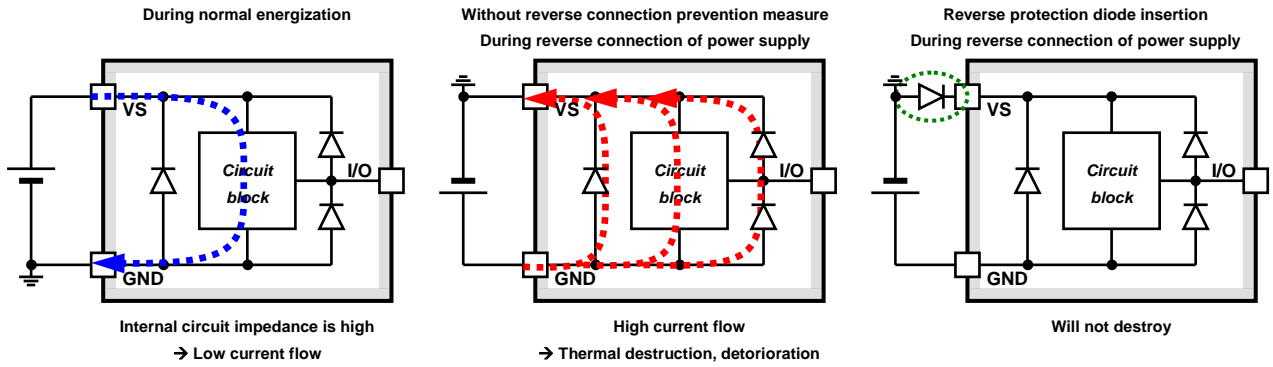

Figure 79. Current Flow during Supply Power Reverse Connection

2. Measures to Raise the Power Supply Pin Voltage by Back Electromotive Force
 Back EMF generates regenerative current to supply power-source. However, when the reverse connection breakdown prevention diode is connected, or when the power source supplied does not have sufficient current absorption ability, the power supply pin and motor drive output pin voltage will rise during regenerative braking.

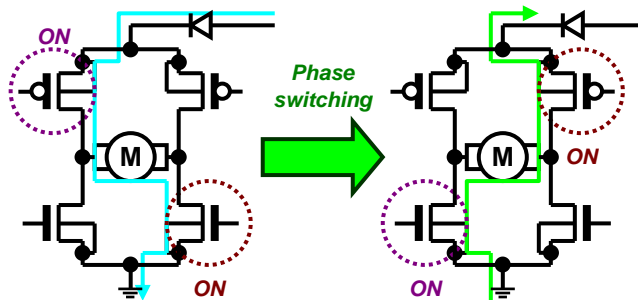

Figure 80. Power Supply Pin and Motor Drive Output Pin Voltage Rise by Back Electromotive Force

If there is a possibility of exceeding the absolute maximum rating due to voltage rise by the back electromotive force, connect a capacitor, a Zener diode, or both as a regenerative current path between the power supply pin and the ground pin. Also connect a Zener diode between output pin and the ground pin.

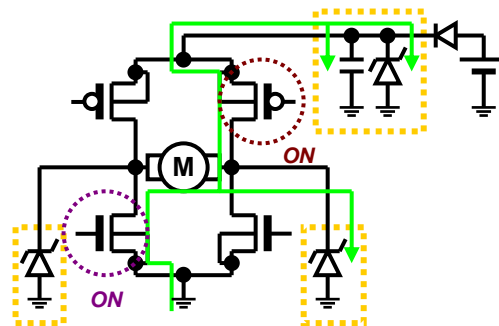

Figure 81. Voltage Rise Countermeasure of Power Supply Pin and Output Pin during Regenerative Braking

Safety Measures - continued

3. Countermeasures against Unstable Power Supply

If there is a possibility that the power supply pin may exceed the absolute maximum rating or the reduced voltage malfunction prevention is operating due to the fluctuation of the power supply, insert an inductor such as a resistor or ferrite beads between the supplied power and the power supply pin and then form a filter.

In that case, use a bypass capacitor together, lower the impedance of the power supply line and supply a stable voltage to the driver.

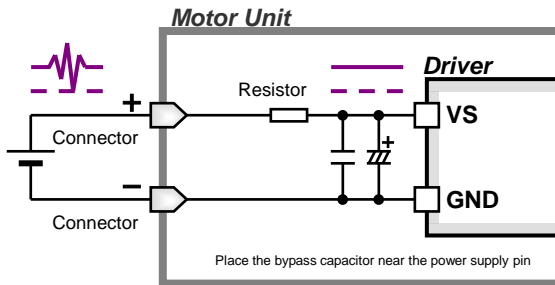

Figure 82. Stable Power Supply Measure (RC Filter)

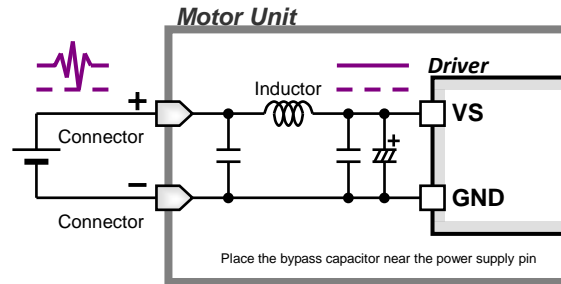

Figure 83. Stable Power Supply Measure (LC Filter)

4. Prohibition of Ground Line PWM Switching Input

The control method of varying the motor speed by PWM switching the ground line is prohibited as it cannot keep the IC ground pin at the lowest potential.

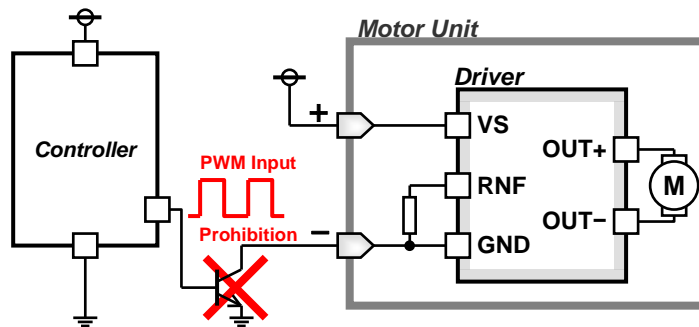

Figure 84. Prohibition of Ground Line PWM Switching

Operational Notes

1. Reverse Connection of Power Supply

Connecting the power supply in reverse polarity can damage the IC. Take precautions against reverse polarity when connecting the power supply, such as mounting an external diode between the power supply and the IC's power supply pins.

2. Power Supply Lines

Design the PCB layout pattern to provide low impedance supply lines. Furthermore, connect a capacitor to ground at all power supply pins. Consider the effect of temperature and aging on the capacitance value when using electrolytic capacitors.

3. Ground Voltage

Ensure that no pins are at a voltage below that of the ground pin at any time, even during transient condition. However, pins that drive inductive loads (e.g. motor driver outputs, DC-DC converter outputs) may inevitably go below ground due to back EMF or electromotive force. In such cases, the user should make sure that such voltages going below ground will not cause the IC and the system to malfunction by examining carefully all relevant factors and conditions such as motor characteristics, supply voltage, operating frequency and PCB wiring to name a few.

4. Ground Wiring Pattern

When using both small-signal and large-current ground traces, the two ground traces should be routed separately but connected to a single ground at the reference point of the application board to avoid fluctuations in the small-signal ground caused by large currents. Also ensure that the ground traces of external components do not cause variations on the ground voltage. The ground lines must be as short and thick as possible to reduce line impedance.

5. Recommended Operating Conditions

The function and operation of the IC are guaranteed within the range specified by the recommended operating conditions. The characteristic values are guaranteed only under the conditions of each item specified by the electrical characteristics.

6. Inrush Current

When power is first supplied to the IC, it is possible that the internal logic may be unstable and inrush current may flow instantaneously due to the internal powering sequence and delays, especially if the IC has more than one power supply. Therefore, give special consideration to power coupling capacitance, power wiring, width of ground wiring, and routing of connections.

7. Operation Under Strong Electromagnetic Field

Operating the IC in the presence of a strong electromagnetic field may cause the IC to malfunction.

8. Testing on Application Boards

When testing the IC on an application board, connecting a capacitor directly to a low-impedance output pin may subject the IC to stress. Always discharge capacitors completely after each process or step. The IC's power supply should always be turned off completely before connecting or removing it from the test setup during the inspection process. To prevent damage from static discharge, ground the IC during assembly and use similar precautions during transport and storage.

9. Inter-pin Short and Mounting Errors

Ensure that the direction and position are correct when mounting the IC on the PCB. Incorrect mounting may result in damaging the IC. Avoid nearby pins being shorted to each other especially to ground, power supply and output pin. Inter-pin shorts could be due to many reasons such as metal particles, water droplets (in very humid environment) and unintentional solder bridge deposited in between pins during assembly to name a few.

10. Unused Input Pins

Input pins of an IC are often connected to the gate of a MOS transistor. The gate has extremely high impedance and extremely low capacitance. If left unconnected, the electric field from the outside can easily charge it. The small charge acquired in this way is enough to produce a significant effect on the conduction through the transistor and cause unexpected operation of the IC. So unless otherwise specified, unused input pins should be connected to the power supply or ground line.

Operational Notes – continued

11. Regarding the Input Pin of the IC

This monolithic IC contains P+ isolation and P substrate layers between adjacent elements in order to keep them isolated. P-N junctions are formed at the intersection of the P layers with the N layers of other elements, creating a parasitic diode or transistor. For example (refer to figure below):

When GND > Pin A and GND > Pin B, the P-N junction operates as a parasitic diode.
 When GND > Pin B, the P-N junction operates as a parasitic transistor.

Parasitic diodes inevitably occur in the structure of the IC. The operation of parasitic diodes can result in mutual interference among circuits, operational faults, or physical damage. Therefore, conditions that cause these diodes to operate, such as applying a voltage lower than the GND voltage to an input pin (and thus to the P substrate) should be avoided.

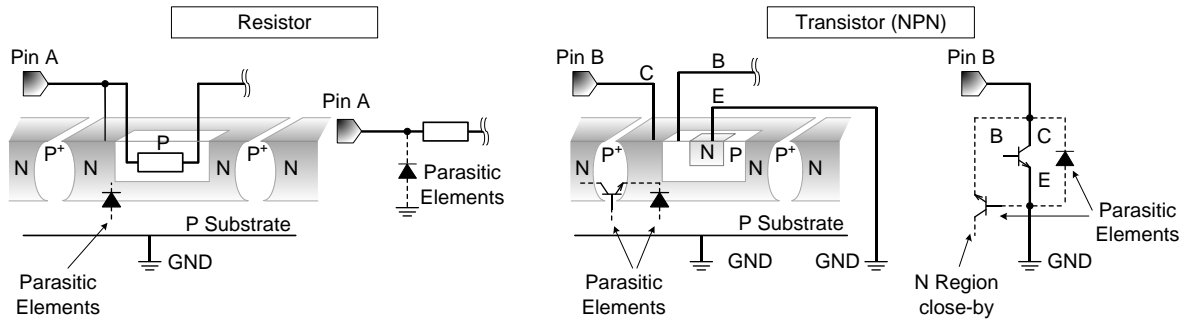

Figure 85. Example of Monolithic IC Structure

12. Ceramic Capacitor

When using a ceramic capacitor, determine a capacitance value considering the change of capacitance with temperature and the decrease in nominal capacitance due to DC bias and others.

13. Area of Safe Operation (ASO)

Operate the IC such that the output voltage, output current, and the maximum junction temperature rating are all within the Area of Safe Operation (ASO).

14. Thermal Shutdown Circuit (TSD)

This IC has a built-in thermal shutdown circuit that prevents heat damage to the IC. Normal operation should always be within the IC's maximum junction temperature rating. If however the rating is exceeded for a continued period, the junction temperature (Tj) will rise which will activate the TSD circuit that will turn OFF power output pins. When the Tj falls below the TSD threshold, the circuits are automatically restored to normal operation.

Note that the TSD circuit operates in a situation that exceeds the absolute maximum ratings and therefore, under no circumstances, should the TSD circuit be used in a set design or for any purpose other than protecting the IC from heat damage.

15. Over Current Protection Circuit (OCP)

This IC incorporates an integrated overcurrent protection circuit that is activated when the load is shorted. This protection circuit is effective in preventing damage due to sudden and unexpected incidents. However, the IC should not be used in applications characterized by continuous operation or transitioning of the protection circuit.

Ordering Information

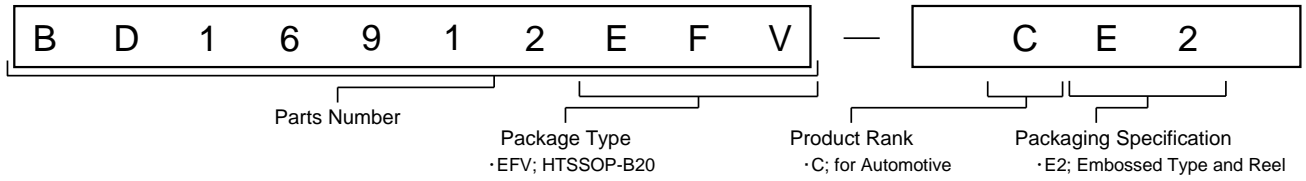

Marking Diagram

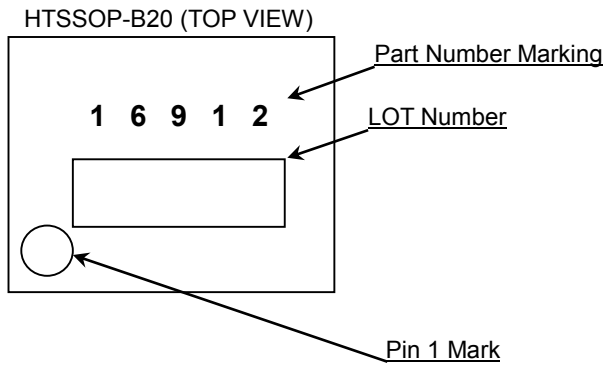

Physical Dimension and Packing Information

Package Name	HTSSOP-B20
--------------	------------

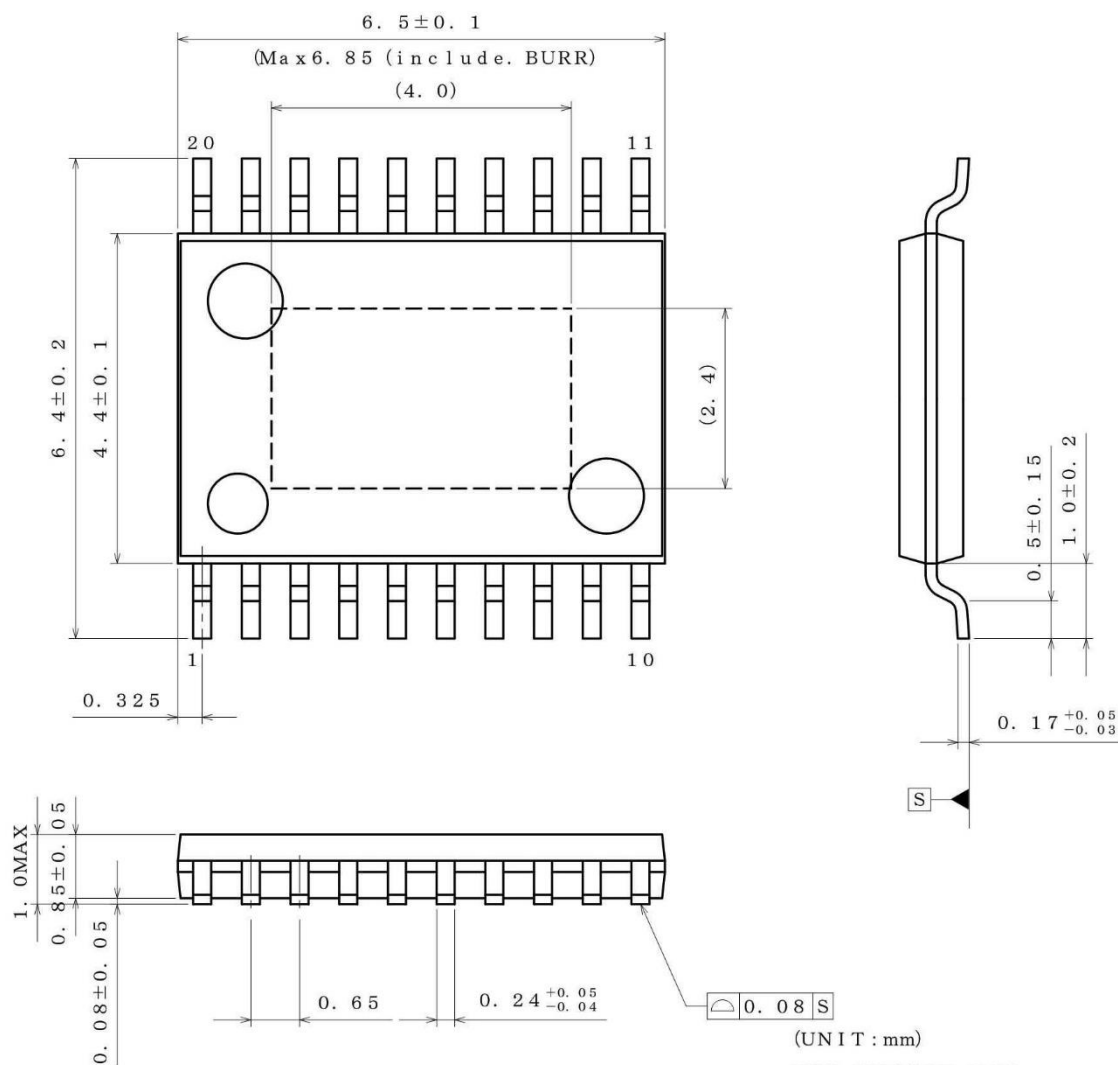

PKG : HTSSOP-B20
 Drawing No. EX192-5002

<Tape and Reel information>

Tape	Embossed carrier tape (with dry pack)
Quantity	2500pcs
Direction of feed	E2 (The direction is the 1 pin of product is at the upper left when you hold reel on the left hand and you pull out the tape on the right hand)

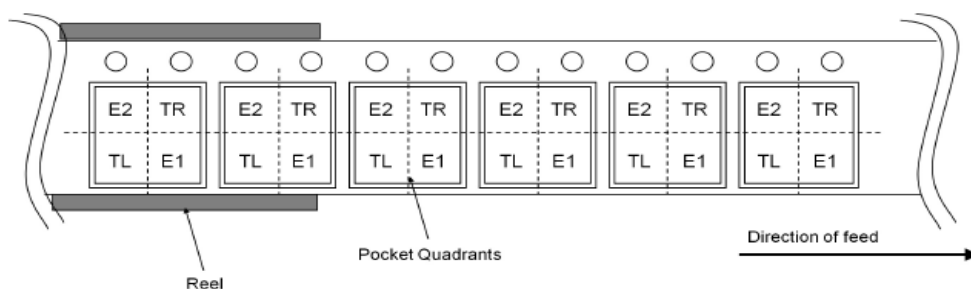

Revision History

Date	Revision	Contents
20.Mar.2018	001	Newly created

Notice

Precaution on using ROHM Products

1. If you intend to use our Products in devices requiring extremely high reliability (such as medical equipment ^(Note 1), aircraft/spacecraft, nuclear power controllers, etc.) and whose malfunction or failure may cause loss of human life, bodily injury or serious damage to property ("Specific Applications"), please consult with the ROHM sales representative in advance. Unless otherwise agreed in writing by ROHM in advance, ROHM shall not be in any way responsible or liable for any damages, expenses or losses incurred by you or third parties arising from the use of any ROHM's Products for Specific Applications.

(Note1) Medical Equipment Classification of the Specific Applications

JAPAN	USA	EU	CHINA
CLASS III	CLASS III	CLASS II b	CLASS III
CLASS IV		CLASS III	

2. ROHM designs and manufactures its Products subject to strict quality control system. However, semiconductor products can fail or malfunction at a certain rate. Please be sure to implement, at your own responsibilities, adequate safety measures including but not limited to fail-safe design against the physical injury, damage to any property, which a failure or malfunction of our Products may cause. The following are examples of safety measures:
 - [a] Installation of protection circuits or other protective devices to improve system safety
 - [b] Installation of redundant circuits to reduce the impact of single or multiple circuit failure
3. Our Products are not designed under any special or extraordinary environments or conditions, as exemplified below. Accordingly, ROHM shall not be in any way responsible or liable for any damages, expenses or losses arising from the use of any ROHM's Products under any special or extraordinary environments or conditions. If you intend to use our Products under any special or extraordinary environments or conditions (as exemplified below), your independent verification and confirmation of product performance, reliability, etc. prior to use, must be necessary:
 - [a] Use of our Products in any types of liquid, including water, oils, chemicals, and organic solvents
 - [b] Use of our Products outdoors or in places where the Products are exposed to direct sunlight or dust
 - [c] Use of our Products in places where the Products are exposed to sea wind or corrosive gases, including Cl₂, H₂S, NH₃, SO₂, and NO₂
 - [d] Use of our Products in places where the Products are exposed to static electricity or electromagnetic waves
 - [e] Use of our Products in proximity to heat-producing components, plastic cords, or other flammable items
 - [f] Sealing or coating our Products with resin or other coating materials
 - [g] Use of our Products without cleaning residue of flux (even if you use no-clean type fluxes, cleaning residue of flux is recommended); or Washing our Products by using water or water-soluble cleaning agents for cleaning residue after soldering
 - [h] Use of the Products in places subject to dew condensation
4. The Products are not subject to radiation-proof design.
5. Please verify and confirm characteristics of the final or mounted products in using the Products.
6. In particular, if a transient load (a large amount of load applied in a short period of time, such as pulse. is applied, confirmation of performance characteristics after on-board mounting is strongly recommended. Avoid applying power exceeding normal rated power; exceeding the power rating under steady-state loading condition may negatively affect product performance and reliability.
7. De-rate Power Dissipation depending on ambient temperature. When used in sealed area, confirm that it is the use in the range that does not exceed the maximum junction temperature.
8. Confirm that operation temperature is within the specified range described in the product specification.
9. ROHM shall not be in any way responsible or liable for failure induced under deviant condition from what is defined in this document.

Precaution for Mounting / Circuit board design

1. When a highly active halogenous (chlorine, bromine, etc.) flux is used, the residue of flux may negatively affect product performance and reliability.
2. In principle, the reflow soldering method must be used on a surface-mount products, the flow soldering method must be used on a through hole mount products. If the flow soldering method is preferred on a surface-mount products, please consult with the ROHM representative in advance.

For details, please refer to ROHM Mounting specification

Precautions Regarding Application Examples and External Circuits

1. If change is made to the constant of an external circuit, please allow a sufficient margin considering variations of the characteristics of the Products and external components, including transient characteristics, as well as static characteristics.
2. You agree that application notes, reference designs, and associated data and information contained in this document are presented only as guidance for Products use. Therefore, in case you use such information, you are solely responsible for it and you must exercise your own independent verification and judgment in the use of such information contained in this document. ROHM shall not be in any way responsible or liable for any damages, expenses or losses incurred by you or third parties arising from the use of such information.

Precaution for Electrostatic

This Product is electrostatic sensitive product, which may be damaged due to electrostatic discharge. Please take proper caution in your manufacturing process and storage so that voltage exceeding the Products maximum rating will not be applied to Products. Please take special care under dry condition (e.g. Grounding of human body / equipment / solder iron, isolation from charged objects, setting of Ionizer, friction prevention and temperature / humidity control).

Precaution for Storage / Transportation

1. Product performance and soldered connections may deteriorate if the Products are stored in the places where:
 - [a] the Products are exposed to sea winds or corrosive gases, including Cl₂, H₂S, NH₃, SO₂, and NO₂
 - [b] the temperature or humidity exceeds those recommended by ROHM
 - [c] the Products are exposed to direct sunshine or condensation
 - [d] the Products are exposed to high Electrostatic
2. Even under ROHM recommended storage condition, solderability of products out of recommended storage time period may be degraded. It is strongly recommended to confirm solderability before using Products of which storage time is exceeding the recommended storage time period.
3. Store / transport cartons in the correct direction, which is indicated on a carton with a symbol. Otherwise bent leads may occur due to excessive stress applied when dropping of a carton.
4. Use Products within the specified time after opening a humidity barrier bag. Baking is required before using Products of which storage time is exceeding the recommended storage time period.

Precaution for Product Label

A two-dimensional barcode printed on ROHM Products label is for ROHM's internal use only.

Precaution for Disposition

When disposing Products please dispose them properly using an authorized industry waste company.

Precaution for Foreign Exchange and Foreign Trade act

Since concerned goods might be fallen under listed items of export control prescribed by Foreign exchange and Foreign trade act, please consult with ROHM in case of export.

Precaution Regarding Intellectual Property Rights

1. All information and data including but not limited to application example contained in this document is for reference only. ROHM does not warrant that foregoing information or data will not infringe any intellectual property rights or any other rights of any third party regarding such information or data.
2. ROHM shall not have any obligations where the claims, actions or demands arising from the combination of the Products with other articles such as components, circuits, systems or external equipment (including software).
3. No license, expressly or implied, is granted hereby under any intellectual property rights or other rights of ROHM or any third parties with respect to the Products or the information contained in this document. Provided, however, that ROHM will not assert its intellectual property rights or other rights against you or your customers to the extent necessary to manufacture or sell products containing the Products, subject to the terms and conditions herein.

Other Precaution

1. This document may not be reprinted or reproduced, in whole or in part, without prior written consent of ROHM.
2. The Products may not be disassembled, converted, modified, reproduced or otherwise changed without prior written consent of ROHM.
3. In no event shall you use in any way whatsoever the Products and the related technical information contained in the Products or this document for any military purposes, including but not limited to, the development of mass-destruction weapons.
4. The proper names of companies or products described in this document are trademarks or registered trademarks of ROHM, its affiliated companies or third parties.

General Precaution

1. Before you use our Products, you are requested to carefully read this document and fully understand its contents. ROHM shall not be in any way responsible or liable for failure, malfunction or accident arising from the use of any ROHM's Products against warning, caution or note contained in this document.
2. All information contained in this document is current as of the issuing date and subject to change without any prior notice. Before purchasing or using ROHM's Products, please confirm the latest information with a ROHM sales representative.
3. The information contained in this document is provided on an "as is" basis and ROHM does not warrant that all information contained in this document is accurate and/or error-free. ROHM shall not be in any way responsible or liable for any damages, expenses or losses incurred by you or third parties resulting from inaccuracy or errors of or concerning such information.