

85°C

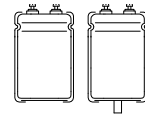

GMX



SCREW TERMINALS

HIGH CV PRODUCT

LONG LIFE 12000 H @ 85 °C

■ FEATURES

- All internal contacts welded
- High capacitance
- High CV product
- Long useful life

■ APPLICATIONS

- Computer
- Industrial
- Inverter/drives
- Laser

RoHS compliant  
REACH compliant

■ GENERAL SPECIFICATIONS

Items	Characteristics
Rated capacitance range $C_R$	390... 3.300.000 $\mu$ F
Capacitance tolerance	$\pm$ 20%
Rated voltage range U	16 ... 450 V
Surge voltage $U_S$	$U_R \leq 315$ V: $U_S = 1,15 U_R$ ; $U_R > 315$ V: $U_S = 1,10 U_R$
Max. reverse voltage	2 V / 20 nH
Category temperature range	- 40°C ... + 85 °C
Leakage current $I_L$ after 5 min @ $U_R$	$\leq 0,008 * C_R [\mu F] * U_R [V] + 6 \mu A [\mu A]$
Useful life 12000 h @ 85 °C ; $U_R$ ; $I_R$	Requirements $\Delta C/C \leq 30$ % of initial value ; ESR $\leq 300$ % of specified ; limit $I_L \leq$ specified limit
Endurance test 4000 h @ 85 °C , $U_R$	Requirements $\Delta C/C \leq 20$ % of initial value ; ESR $\leq 130$ % of specified ; limit $I_L \leq$ specified limit
Climatic category IEC 60068	40/085/56
Voltage proof of the external insulation	$\geq 2500$ V AC
Sectional specification	IEC 60384-4

Different voltages and capacitance combinations are available on request. Also in small lots.

Stand: 12/2019



■ DRAWINGS FOR SERIES GMXA AND GMXB

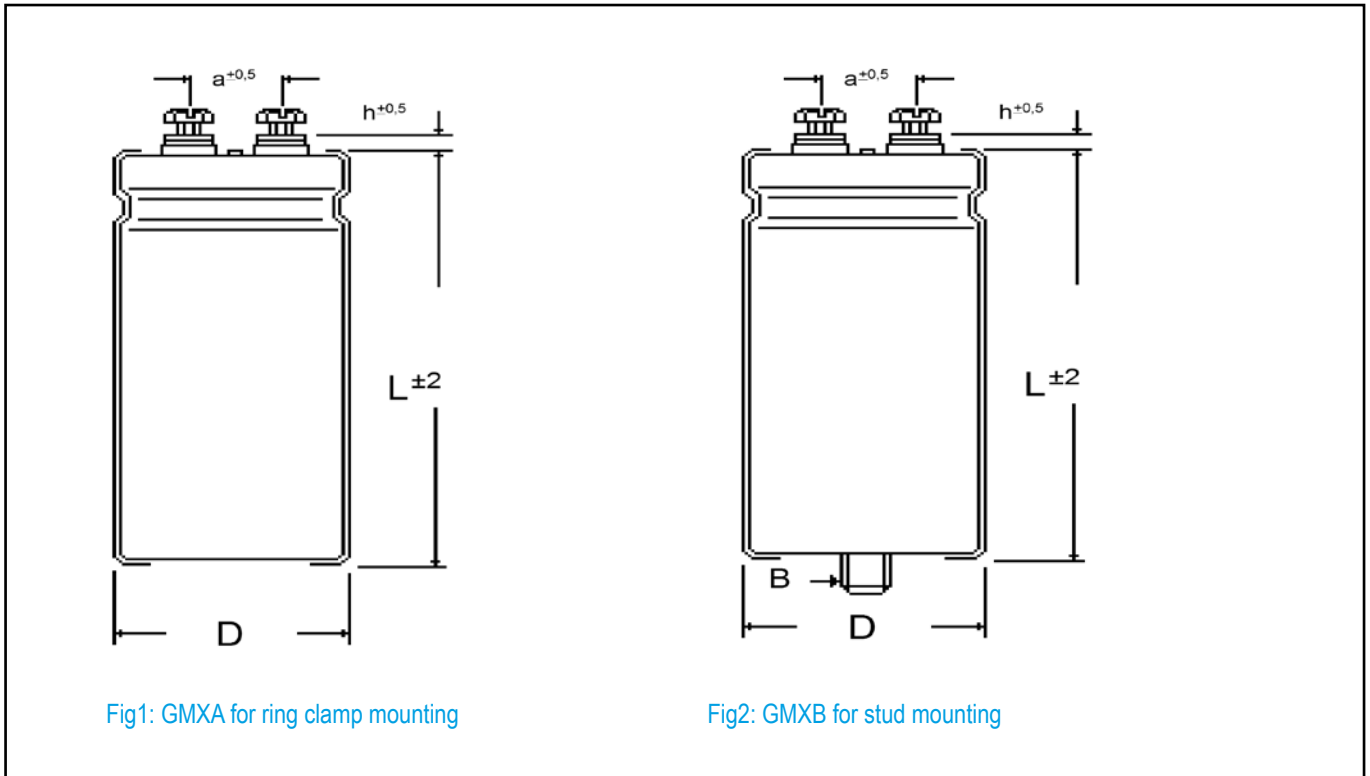

■ DIMENSIONS AND MECHANICAL DATA

Dimensions, case with insulation sleeve				Connecting terminals		Mounting stud, GMB only	
D [mm]	Case length L available in 5 mm [mm]	h [mm]	a [mm]	Thread	Max. torque [Nm]	B	Max. torque [Nm]
35	40 ... 120	6	13	M5	2,0	M8 x 12	4,0
40	40 ... 120	5	18	M5	2,0	M8 x 12	4,0
50	40 ... 120	5	22	M5	2,0	M12 x 16	10,0
65	40 ... 180	5	28,5	M5	2,0	M12 x 16	10,0
75	40 ... 230	5	31,7	M5 ; M6	2,0 ; 2,5	M12 x 16	10,0
90	40 ... 230	5	31,7	M6	2,5	M12 x 16	10,0

GMA: connecting screws M5 or M6

GMB: connecting screws M5 or M6 + mounting nut M8 or M12

Remarks: Further mounting accessories like clamps, nylon cup nuts and insulation disks on request, see "accessory equipment".

85°C

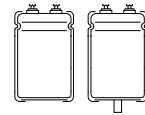

GMX

ELECTRICAL DATA AND ORDERING CODE FOR SERIES GMX

Rated voltage $U_R$ [V]	Rated cap. $C_R$ [µF]	Case size D x L [mm]	Typ. ESR 100 Hz, 20°C [mΩ]	Ripple current IR~ 100 Hz, 85°C [A]	Order code	
					Plain base: GMXA...	
16	82000	35x55	6	9,0	82301635055	
	120000	35x70	4	12,0	12401635070	
	120000	40x55	4	11,1	12401640055	
	150000	35x80	3	14,2	15401635080	
	150000	40x70	3	13,7	15401640070	
	180000	35x100	3	17,0	18401635100	
	180000	40x80	3	15,8	18401640080	
	180000	45x70	3	15,0	18401645070	
	220000	40x100	2	19,1	22401640100	
	220000	50x70	2	17,7	22401650070	
	270000	45x100	2	21,1	27401645100	
	270000	50x80	2	20,6	27401650080	
	390000	50x100	1	27,0	39401650100	
	470000	65x80	1	35,6	47401665080	
	560000	65x100	1	42,1	56401665100	
	820000	65x130	1	56,5	82401665130	
	820000	75x100	1	44,1	82401675100	
	1000000	75x115	1	46,5	10501675115	
	1200000	75x145	1	50,8	12501675145	
	1500000	75x165	1	53,5	15501675165	
	1800000	90x148	1	57,3	18501690148	
	2200000	75x225	1	61,0	22501675225	
	2200000	90x170	1	60,4	22501690170	
	2700000	90x220	1	67,1	27501690220	
	3300000	90x230	1	68,3	33501690230	
	25	22000	35x55	20	4,8	22302535055
		33000	35x70	14	6,5	33302535070
		33000	40x55	14	6,1	33302540055
39000		35x80	11	7,5	39302535080	
47000		40x70	9	7,9	47302540070	
56000		35x100	8	9,8	56302535100	
56000		40x80	8	9,1	56302540080	
56000		45x70	8	8,6	56302545070	
68000		40x100	7	11,0	68302540100	
68000		50x70	7	10,2	68302550070	
68000		45x100	7	11,0	68302545100	
82000		50x80	5	11,7	82302550080	
120000		50x100	4	15,5	12402550100	
120000		65x80	4	18,3	12402565080	
180000		65x100	3	24,3	18402565100	
220000		75x100	2	23,2	22402575100	
270000		65x130	2	33,0	27402565130	
270000		75x115	2	27,1	27402575115	
390000		75x145	1	35,7	39402575145	
470000		75x165	1	41,2	47402575165	
560000		90x148	1	48,1	56402590148	
680000		75x225	1	56,5	68402575225	

Rated voltage $U_R$ [V]	Rated cap. $C_R$ [µF]	Case size D x L [mm]	Typ. ESR 100 Hz, 20°C [mΩ]	Ripple current IR~ 100 Hz, 85°C [A]	Order code	
					Plain base: GMXA...	
25	680000	90x170	1	56,0	68402590170	
	820000	90x220	1	68,2	82402590220	
	1000000	90x230	1	76,8	10502590230	
40	15000	35x55	25	4,3	15304035055	
	18000	40x55	21	4,8	18304040055	
	22000	35x70	17	5,7	22304035070	
	27000	35x80	14	6,7	27304035080	
	27000	40x70	14	6,5	27304040070	
	33000	35x100	12	8,1	33304035100	
	33000	40x80	12	7,5	33304040080	
	33000	45x70	12	7,2	33304045070	
	39000	50x70	10	8,3	39304050070	
	47000	40x100	8	9,9	47304040100	
	47000	50x80	8	9,6	47304050080	
	56000	45x100	7	10,7	56304045100	
	68000	50x100	6	12,6	68304050100	
	82000	65x80	5	16,6	82304065080	
	120000	65x100	3	21,8	12404065100	
	150000	75x100	3	21,1	15404075100	
	150000	65x130	3	27,0	15404065130	
	180000	75x115	2	24,3	18404075115	
	220000	75x145	2	29,4	22404075145	
	270000	75x165	1	34,3	27404075165	
	330000	90x148	1	40,6	33404090148	
	390000	75x225	1	47,0	39404075225	
	390000	90x170	1	46,6	39404090170	
	560000	90x220	1	62,0	56404090220	
	560000	90x230	1	63,1	56404090230	
	63	6800	35x55	42	3,4	68206335055
		8200	40x55	35	3,8	82206340055
		10000	35x70	29	4,5	10306335070
12000		35x80	24	5,2	12306335080	
12000		40x70	24	5,0	12306340070	
15000		35x100	19	6,3	15306335100	
15000		40x80	19	5,9	15306340080	
15000		45x70	19	5,6	15306345070	
18000		50x70	16	6,5	18306350070	
18000		40x100	16	7,1	18306340100	
22000		50x80	13	7,6	22306350080	
22000		45x100	13	7,8	22306345100	
27000		50x100	11	9,2	27306350100	
39000		65x80	7	13,2	39306365080	
47000		65x100	6	15,8	47306365100	
68000		75x100	4	16,4	68306375100	
68000		65x130	4	21,0	68306365130	
82000		75x115	3	19,0	82306375115	
100000		75x145	3	22,9	10406375145	

Stand: 12/2019

85°C

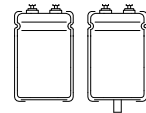

GMX

Rated voltage $U_R$ [V]	Rated cap. $C_R$ [μF]	Case size D x L [mm]	Typ. ESR 100 Hz, 20°C [mΩ]	Ripple current IR~ 100 Hz, 85°C [A]	Order code		
					Plain base: GMXA...		
					Stud mounting: GMXB...		
63	120000	75x165	2	26,4	12406375165		
	150000	90x148	2	31,6	15406390148		
	180000	75x225	2	36,9	18406375225		
	180000	90x170	2	36,6	18406390170		
	220000	90x220	1	44,9	22406390220		
	270000	90x230	1	50,6	27406390230		
	3900	35x55	82	2,4	39208035055		
	5600	35x70	57	3,2	56208035070		
80	6800	35x80	47	3,7	68208035080		
	6800	40x70	47	3,6	68208040070		
	8200	40x55	39	3,6	82208040055		
	8200	35x100	39	4,4	82208035100		
	8200	40x80	39	4,1	82208040080		
	10000	45x70	32	4,3	10308045070		
	12000	50x70	27	5,1	12308050070		
	12000	45x100	27	5,4	12308045100		
	15000	40x100	21	6,1	15308040100		
	15000	50x80	21	5,9	15308050080		
	18000	50x100	18	7,1	18308050100		
	22000	65x80	14	9,4	22308065080		
	27000	65x100	12	11,3	27308065100		
	39000	75x100	8	11,8	39308075100		
	39000	65x130	8	15,1	39308065130		
	47000	75x115	7	13,6	47308075115		
	68000	75x145	5	17,9	68308075145		
	68000	75x165	5	18,9	68308075165		
	100000	90x148	3	24,5	10408090148		
	120000	75x225	3	28,6	12408075225		
	120000	90x170	3	28,3	12408090170		
	150000	90x220	2	35,1	15408090220		
	150000	90x230	2	35,8	15408090230		
	3300	35x55	48	3,1	33210035055		
	4700	35x70	34	4,1	47210035070		
	100	4700	40x55	34	3,8	47210040055	
		5600	35x80	28	4,7	56210035080	
		5600	40x70	28	4,6	56210040070	
		6800	35x100	23	5,7	68210035100	
		6800	40x80	23	5,3	68210040080	
		8200	45x70	19	5,5	82210045070	
		10000	50x70	16	6,5	10310050070	
10000		40x100	16	7,1	10310040100		
12000		45x100	13	7,7	12310045100		
12000		50x80	13	7,5	12310050080		
15000		50x100	11	9,2	15310050100		
18000		65x80	9	12,1	18310065080		
22000		65x100	7	14,5	22310065100		
27000		75x100	6	13,9	27310075100		
33000		65x130	5	19,6	33310065130		
39000		75x115	4	17,6	39310075115		

Rated voltage $U_R$ [V]	Rated cap. $C_R$ [μF]	Case size D x L [mm]	Typ. ESR 100 Hz, 20°C [mΩ]	Ripple current IR~ 100 Hz, 85°C [A]	Order code		
					Plain base: GMXA...		
					Stud mounting: GMXB...		
100	47000	75x145	3	21,1	47310075145		
	56000	75x165	3	24,2	56310075165		
	68000	90x148	2	28,6	68310090148		
	82000	75x225	2	33,4	82310075225		
	82000	90x170	2	33,1	82310090170		
	120000	90x220	1	44,5	12410090220		
	120000	90x230	1	45,3	12410090230		
	160	1800	35x55	62	2,8	18216035055	
2200		35x70	51	3,4	22216035070		
2200		40x55	51	3,1	22216040055		
2700		35x80	41	3,9	27216035080		
2700		40x70	41	3,8	27216040070		
3900		35x100	29	5,2	39216035100		
3900		40x80	29	4,8	39216040080		
3900		45x70	29	4,6	39216045070		
4700		50x70	24	5,4	47216050070		
4700		40x100	24	5,8	47216040100		
5600		45x100	20	6,3	56216045100		
5600		50x80	20	6,1	56216050080		
6800		50x100	16	7,4	68216050100		
8200		65x80	14	9,7	82216065080		
12000		65x100	9	12,8	12316065100		
15000		75x100	7	12,4	15316075100		
18000		65x130	6	17,3	18316065130		
18000		75x115	6	14,3	18316075115		
250		27000	75x145	4	19,1	27316075145	
		27000	75x165	4	20,1	27316075165	
	39000	75x225	3	27,5	39316075225		
	39000	90x148	3	25,9	39316090148		
	47000	90x170	2	30,0	47316090170		
	56000	90x220	2	36,3	56316090220		
	56000	90x230	2	37,0	56316090230		
	1000	35x55	96	2,2	10225035055		
	1500	35x70	64	3,0	15225035070		
	1500	40x55	64	2,8	15225040055		
	1800	35x80	53	3,5	18225035080		
	1800	40x70	53	3,3	18225040070		
	2200	35x100	43	4,2	22225035100		
	2200	40x80	43	3,9	22225040080		
	2200	45x70	43	3,7	22225045070		
	2700	50x70	35	4,4	27225050070		
	3300	40x100	29	5,2	33225040100		
	3900	45x100	24	5,7	39225045100		
	3900	50x80	24	5,5	39225050080		
	4700	50x100	20	6,6	47225050100		
5600	65x80	17	8,7	56225065080			
8200	65x100	12	11,4	82225065100			
10000	75x100	10	10,9	10325075100			
12000	65x130	8	15,3	12325065130			

Stand: 12/2019

85°C

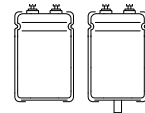

GMX

Rated voltage $U_R$ [V]	Rated cap. $C_R$ [μF]	Case size D x L [mm]	Typ. ESR 100 Hz, 20°C [mΩ]	Ripple current IR~ 100 Hz, 85°C [A]	Order code
					Plain base: GMXA...
					Stud mounting: GMXB...
250	12000	75x115	8	12,6	12325075115
	18000	75x145	5	16,8	18325075145
	18000	75x165	5	17,7	18325075165
	27000	75x225	4	24,7	27325075225
	27000	90x148	4	23,2	27325090148
	27000	90x170	4	24,5	27325090170
	39000	90x220	2	32,7	39325090220
	39000	90x230	2	33,3	39325090230
	350	560	35x55	171	1,7
680		40x55	141	1,9	68135040055
820		35x70	117	2,2	82135035070
1000		35x80	96	2,6	10235035080
1200		40x70	80	2,7	12235040070
1200		45x70	80	2,7	12235045070
1500		35x100	64	3,5	15235035100
1500		40x80	64	3,2	15235040080
1800		50x70	53	3,6	18235050070
1800		40x100	53	3,9	18235040100
1800		50x80	53	3,8	18235050080
2200		45x100	43	4,3	22235045100
2700		50x100	35	5,0	27235050100
3300		65x80	29	6,7	33235065080
3900		65x100	24	7,9	39235065100
4700		75x100	20	7,5	47235075100
5600		65x130	17	10,4	56235065130
5600		75x115	17	8,6	56235075115
8200		75x145	12	11,4	82235075145
8200		75x165	12	12,0	82235075165
12000		75x225	8	16,5	12335075225
12000	90x148	8	15,5	12335090148	
15000	90x170	6	18,3	15335090170	
18000	90x220	5	22,2	18335090220	
18000	90x230	5	22,6	18335090230	
400	390	35x55	327	1,2	39140035055
	560	35x70	227	1,6	56140035070
	560	40x55	227	1,5	56140040055
	680	35x80	187	1,8	68140035080
	820	40x70	155	2,0	82140040070
	820	40x80	155	2,1	82140040080
	1000	35x100	127	2,5	10240035100
	1000	45x70	127	2,2	10240045070
	1200	50x70	106	2,5	12240050070
	1200	40x100	106	2,7	12240040100

Rated voltage $U_R$ [V]	Rated cap. $C_R$ [μF]	Case size D x L [mm]	Typ. ESR 100 Hz, 20°C [mΩ]	Ripple current IR~ 100 Hz, 85°C [A]	Order code	
					Plain base: GMXA...	
					Stud mounting: GMXB...	
400	1500	45x100	85	3,0	15240045100	
	1500	50x80	85	3,0	15240050080	
	1800	50x100	71	3,6	18240050100	
	2200	65x80	58	4,7	22240065080	
	2700	65x100	47	5,7	27240065100	
	3300	65x100	40	5,8	33240065100	
	3900	75x100	33	5,9	39240075100	
	3900	65x130	33	7,5	39240065130	
	4700	75x115	27	6,8	47240075115	
	6800	75x145	19	9,0	68240075145	
	6800	75x165	19	9,4	68240075165	
	10000	90x148	13	12,2	10340090148	
	12000	75x225	11	14,3	12340075225	
	12000	90x170	11	14,2	12340090170	
	15000	90x220	8	17,6	15340090220	
	18000	90x230	7	19,6	18340090230	
	450	390	35x55	286	1,3	39145035055
		470	35x70	237	1,6	47145035070
560		35x80	199	1,8	56145035080	
560		35x100	199	2,0	56145035100	
680		40x55	164	1,7	68145040055	
820		40x70	136	2,1	82145040070	
820		40x80	136	2,2	82145040080	
1000		45x70	111	2,3	10245045070	
1000		40x100	111	2,7	10245040100	
1200		50x70	93	2,7	12245050070	
1200		45x100	93	2,9	12245045100	
1200		50x80	93	2,8	12245050080	
1800		50x100	62	3,8	18245050100	
1800		65x80	62	4,6	18245065080	
2700		65x100	41	6,1	27245065100	
3300		65x130	34	7,4	33245065130	
3900		75x100	29	6,3	39245075100	
3900		75x115	29	6,6	39245075115	
4700		75x145	26	7,6	47245075145	
5600		75x145	20	8,7	56245075145	
6800		75x165	16	10,1	68245075165	
8200		75x225	14	12,6	82245075225	
10000		90x148	11	13,1	10345090148	
10000		90x170	11	13,8	10345090170	
15000	90x220	7	18,8	15345090220		
15000	90x230	7	19,1	15345090230		
12000	90x220	7	17,9	12345090220		

85°C

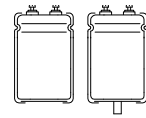

GMX

■ USEFUL LIFE AS A FUNCTION OF AMBIENT TEMPERATURE AND ACTUAL RIPPLE CURRENT

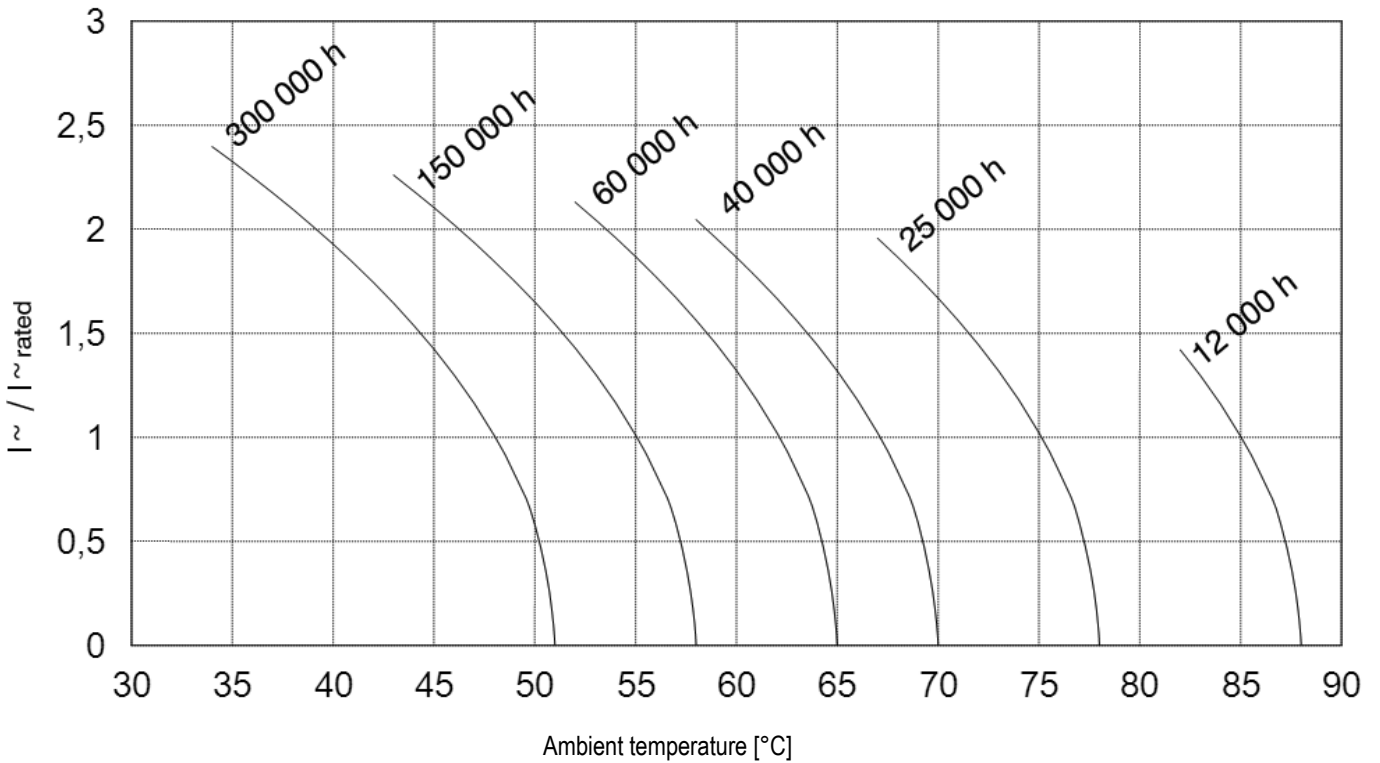

■ RIPPLE CURRENT AND ESR AS A FUNCTION OF FREQUENCY F

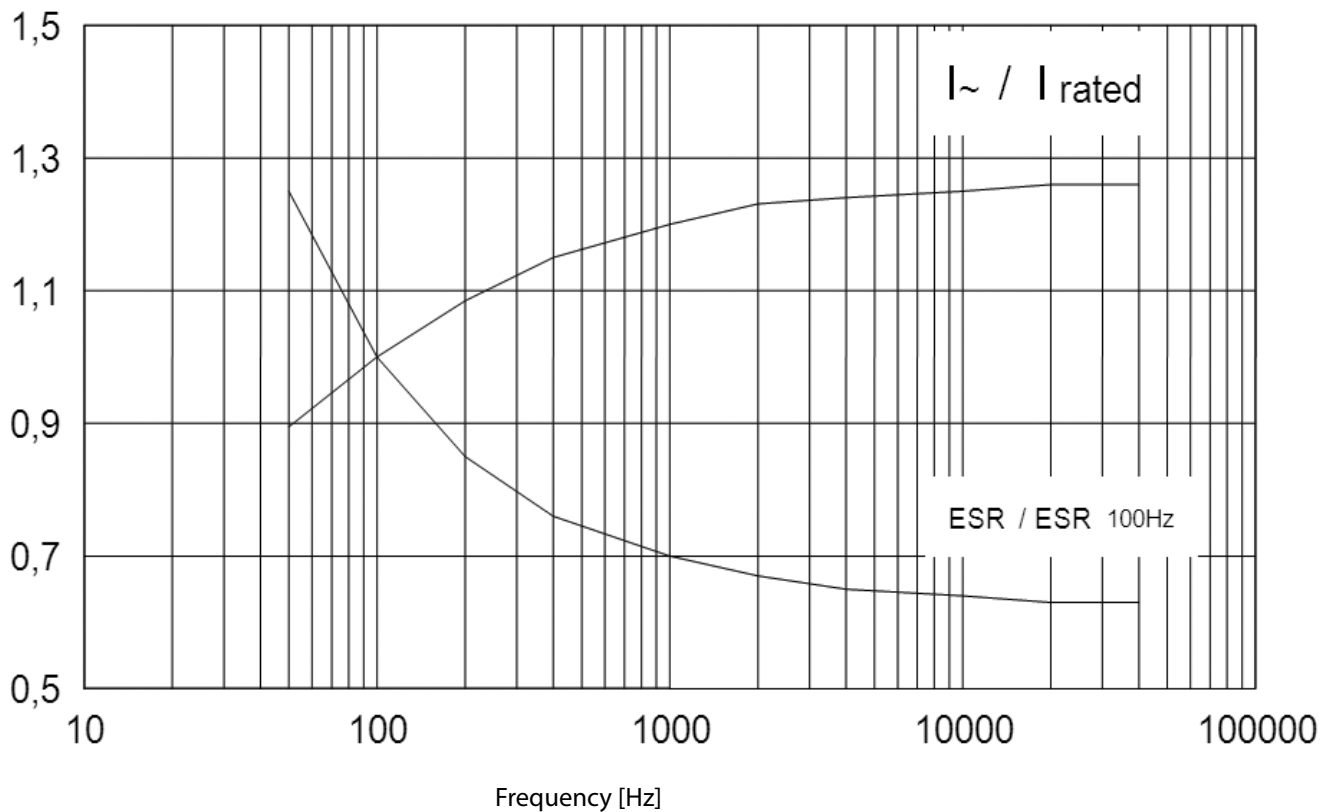

Stand: 12/2019