

SUPPRESSOR FOR CONTACTORS

RC, 230 VAC/DC, 20 VA/W

230 V AC/DC
RC

For other configurations and voltages, please inquire

[Link to Product](#)**Illustration**

RC

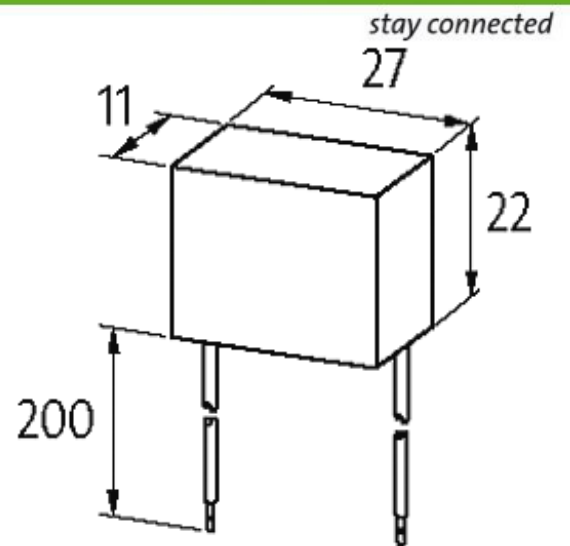

Product may differ from Image

Approvals



Appropriate contactors

universal

Technical Data

Damping factor	approx. 1.5 × UN
Material	Flame retardant plastic acc. to (UL 94)
Connection wires	flexible connection wires
Max. power (W)	20 W(VA)

General data

Temperature range	-20...+70 °C
Dimensions H × W × D	22×27×11 mm

Commercial data

country of origin	CZ
customs tariff number	85363010
minimum order quantity	1