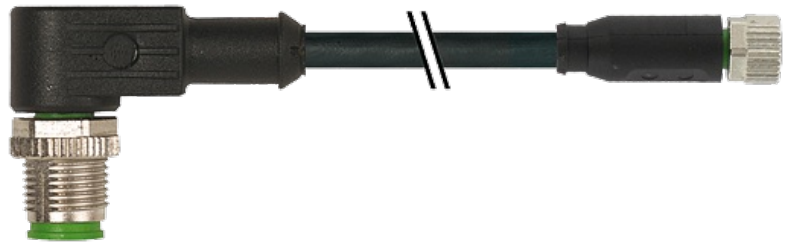

**M12 male 90° / M8 female 0°**

PUR 3x0.25 bk UL/CSA+robot+drag chain 0,6m

Male 90° to female straight  
M12 - M8, 3-pole

Plastic housings with good resistance against chemicals and oils. The resistance to aggressive media should be individually tested for your application. Further details on request. Further cable lengths on request.

**[Link to Product](#)****Illustration**

Male

Female

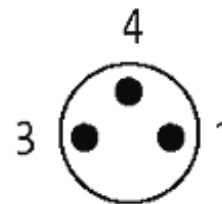
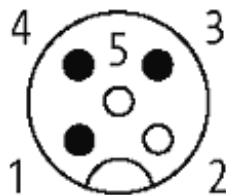

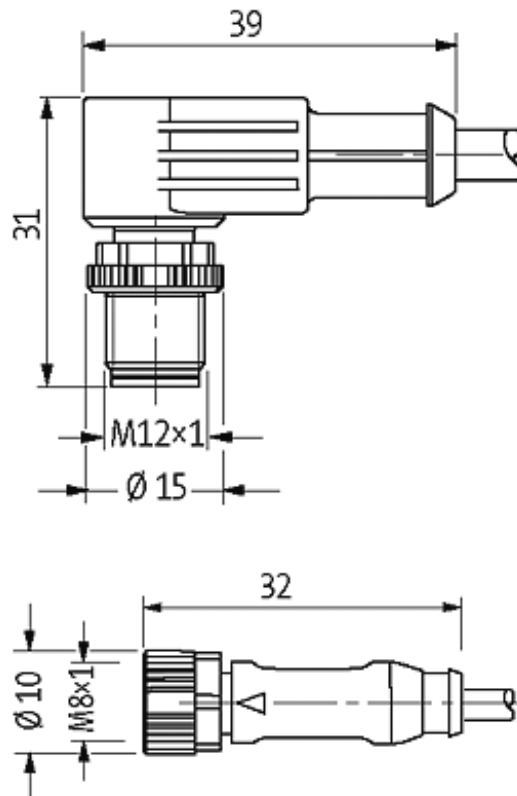

Product may differ from Image

### Approvals



### Form

40661

### Technical Data

Protection	IP67 inserted and tightened (EN 60529)
Locking of ports	Screw thread M8/M12 × 1 mm (recommended torque 0.4/0.6 Nm), self-securing
Operating voltage	max. 250 V AC/DC
Operating current per contact	max. 4 A

### Cables

Cable number	650
No./diameter of wires	3 × 0.25 mm <sup>2</sup>
Wire isolation	PP (br, bl, bk)
C-track properties	10 Mio.
Torsion	1 Mio. ± 360°/m
Jacket Color	black
Shore hardness outer jacket	58 ± 3D
Material (jacket)	PUR (UL/CSA), welding spark res.

The information in this brochure has been compiled with the utmost care.

Liability for the correctness completeness and topicality of the information is restricted to gross negligence. Version: 05/15

Outer diameter	approx. 4.3 mm
Bend radius (fixed)	5 × outer Ø
Bend radius (moving)	10 × outer Ø
Temperature range (fixed)	-40...+90 °C
Temperature range (mobile)	-25...+90 °C

**General data**

Temperature range	-25...+85 °C, depending on cable quality
-------------------	--

**Commercial data**

country of origin	DE
customs tariff number	85444290
minimum order quantity	1