







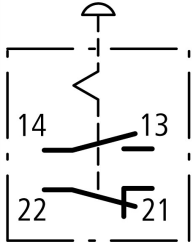
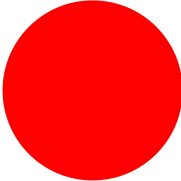
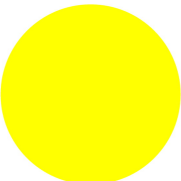
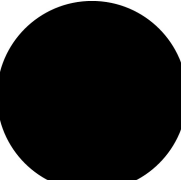

**Palm switch, 1N/O+1N/C, emergency switching off, surface mounting**

**Part no.** FAK-R/V/KC11/IY  
**Article no.** 229748  
**Catalog No.** FAK-R-V-KC11-IY

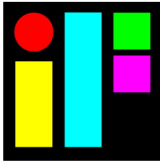
## Delivery programme

Product range		Foot and palm switches
Basic function		Basic devices
Single unit/Complete unit		Complete unit
Function		maintained
Description		Pull to release Emergency stop pushbutton tamper-proof to ISO 13850/EN 418
<b>Contacts</b>		
N/O = Normally open		1 N/O
N/C = Normally closed		1 NC 
Notes		 = safety function, by positive opening to IEC/EN 60947-5-1
<b>Enclosure color</b>		
Colour		Enclosure base RAL 9005, black Operator only RAL 1004, yellow
Contact sequence		yellow 
<b>Colour</b>		
Button		Red 
Gehäuseoberteil		Yellow 
Gehäuseunterteil		Black 

Approval			 <b>INDUSTRIE FORUM DESIGN HANNOVER</b>    
Connection to SmartWire-DT			no

## Technical data

### General

Lifespan, mechanical	Operations	$\times 10^6$	> 0.1
Operating frequency	Operations/h		$\leq 600$
Actuating force	N		40 - 60
Degree of protection, IEC/EN 60529			IP67, IP69K
Climatic proofing			Damp heat, constant, to IEC 60068-2-78 Damp heat, cyclic, to IEC 60068-2-30
Ambient temperature	°C		
Open	°C		-25 - +40
Mounting position			As required
Mechanical shock resistance	g		> 15 Shock duration 11 ms Sinusoidal according to IEC 60068-2-27

## Design verification as per IEC/EN 61439

Technical data for design verification			
Rated operational current for specified heat dissipation	$I_n$	A	6
Heat dissipation per pole, current-dependent	$P_{vid}$	W	0.11
Equipment heat dissipation, current-dependent	$P_{vid}$	W	0
Static heat dissipation, non-current-dependent	$P_{vs}$	W	0
Heat dissipation capacity	$P_{diss}$	W	0
Operating ambient temperature min.		°C	-25
Operating ambient temperature max.		°C	40
IEC/EN 61439 design verification			
10.2 Strength of materials and parts			
10.2.2 Corrosion resistance			Meets the product standard's requirements.
10.2.3.1 Verification of thermal stability of enclosures			Meets the product standard's requirements.
10.2.3.2 Verification of resistance of insulating materials to normal heat			Meets the product standard's requirements.
10.2.3.3 Verification of resistance of insulating materials to abnormal heat and fire due to internal electric effects			Meets the product standard's requirements.
10.2.4 Resistance to ultra-violet (UV) radiation			Please enquire
10.2.5 Lifting			Does not apply, since the entire switchgear needs to be evaluated.
10.2.6 Mechanical impact			Does not apply, since the entire switchgear needs to be evaluated.
10.2.7 Inscriptions			Meets the product standard's requirements.
10.3 Degree of protection of ASSEMBLIES			Does not apply, since the entire switchgear needs to be evaluated.
10.4 Clearances and creepage distances			Meets the product standard's requirements.
10.5 Protection against electric shock			Does not apply, since the entire switchgear needs to be evaluated.
10.6 Incorporation of switching devices and components			Does not apply, since the entire switchgear needs to be evaluated.
10.7 Internal electrical circuits and connections			Is the panel builder's responsibility.

10.8 Connections for external conductors		Is the panel builder's responsibility.
10.9 Insulation properties		
10.9.2 Power-frequency electric strength		Is the panel builder's responsibility.
10.9.3 Impulse withstand voltage		Is the panel builder's responsibility.
10.9.4 Testing of enclosures made of insulating material		Is the panel builder's responsibility.
10.10 Temperature rise		The panel builder is responsible for the temperature rise calculation. Eaton will provide heat dissipation data for the devices.
10.11 Short-circuit rating		Is the panel builder's responsibility. The specifications for the switchgear must be observed.
10.12 Electromagnetic compatibility		Is the panel builder's responsibility. The specifications for the switchgear must be observed.
10.13 Mechanical function		The device meets the requirements, provided the information in the instruction leaflet (IL) is observed.

## Technical data ETIM 6.0

Low-voltage industrial components (EG000017) / Foot-/palm switch complete (EC000231)		
Electric engineering, automation, process control engineering / Low-voltage switch technology / Command and alarm device / Foot, palm switch (ecl@ss8.1-27-37-12-17 [AKF035011])		
Unlocking method		Pull release
Colour cap		Red
Number of contacts as normally open contact		1
Number of contacts as normally closed contact		1
Switching function latching		Yes
Spring-return		No
Hole diameter	mm	0
Degree of protection (IP)		IP67

## Approvals

Product Standards		IEC/EN 60947-5; UL 508; CSA-C22.2 No. 14-05; CSA-C22.2 No. 94-91; CE marking
UL File No.		E29184
UL Category Control No.		NKCR
CSA File No.		012528
CSA Class No.		3211-03
North America Certification		UL listed, CSA certified
Degree of Protection		UL/CSA Type 3R, 4X, 12, 13

## Dimensions

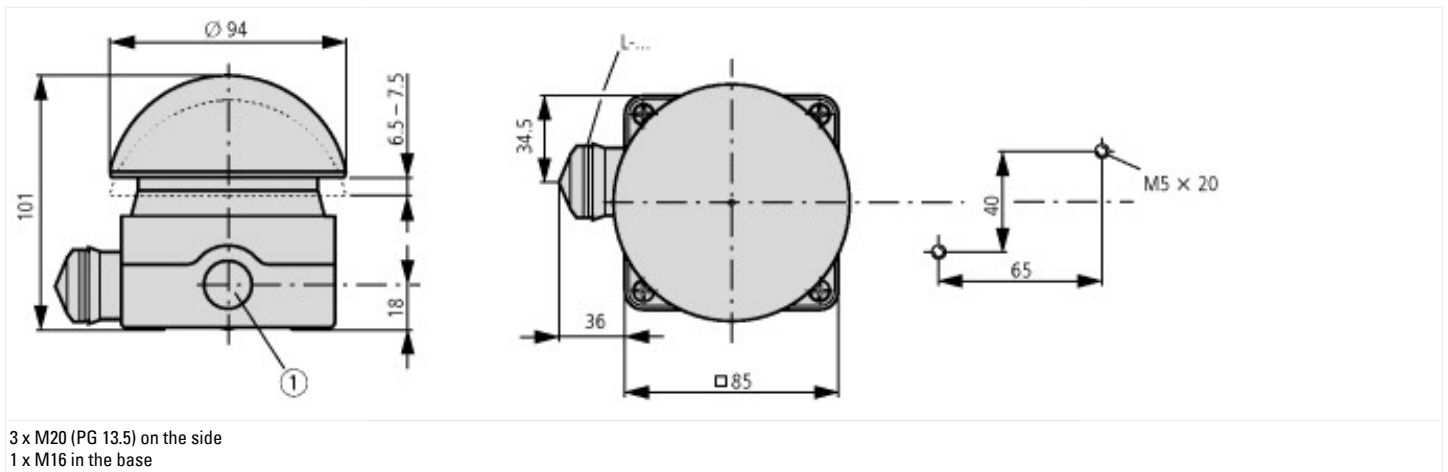

## Additional product information (links)

<b>IL04716006Z (AWA1160-1696) Indicator light</b>	
IL04716006Z (AWA1160-1696) Indicator light	<a href="ftp://ftp.moeller.net/DOCUMENTATION/AWA_INSTRUCTIONS/IL04716006Z2011_02.pdf">ftp://ftp.moeller.net/DOCUMENTATION/AWA_INSTRUCTIONS/IL04716006Z2011_02.pdf</a>
<b>IL04716017Z (AWA1160-1467) Foot and palm switches</b>	
IL04716017Z (AWA1160-1467) Foot and palm switches	<a href="ftp://ftp.moeller.net/DOCUMENTATION/AWA_INSTRUCTIONS/IL04716017Z2011_02.pdf">ftp://ftp.moeller.net/DOCUMENTATION/AWA_INSTRUCTIONS/IL04716017Z2011_02.pdf</a>