

# LUXEON Rebel and LUXEON Rebel ES

## Color Portfolio

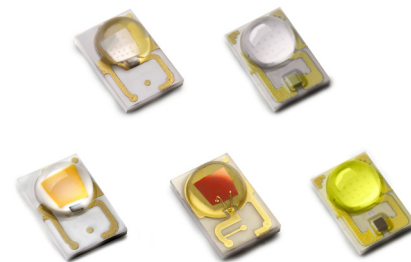

## Introduction

With leading light output, color stability, flux density, and clear saturated colors, the LUXEON Rebel and LUXEON Rebel ES emitters are ideal for a wide variety of lighting, signaling, signage and entertainment applications. Every LUXEON Rebel and LUXEON Rebel ES emitter has built-in quality, reliability, lumen maintenance and the ease of manufacturing needed to create a superior high quality light. Using the information in this document you can begin designing applications to your unique specifications.

### Features and Benefits

- Deliver more usable light and higher flux density
- Optimize applications to reduce size and cost
- Tightly pack the LEDs for color mixing
- Engineer more robust applications
- Utilize standard FR4 PCB technology
- Simplify manufacturing through the use of surface mount technology
- Recognized under the Component Recognition Program of Underwriters Laboratories Inc. UL listing E327436.

### Key Applications

- Architecture
  - Entertainment
  - Studio
- Lamps
  - Remote Phosphor
- Specialty
  - Emergency Vehicle

# Table of Contents

General Information .....	2
Product Nomenclature .....	2
Average Lumen Maintenance Characteristics .....	3
Environmental Compliance .....	3
Product Selection & Optical Characteristics .....	4
Flux Performance, Binning, and Supportability .....	5
Electrical Characteristics .....	6
Absolute Maximum Ratings .....	6
JEDEC Moisture Sensitivity .....	6
Reflow Soldering Characteristics .....	7
Mechanical Dimensions .....	8
Pad Configuration .....	10
Solder Pad Design .....	10
Wavelength Characteristics .....	11
Typical Light Output Characteristics .....	12
Typical Forward Current Characteristics .....	13
Typical Relative Luminous Flux .....	14
Typical Radiation Patterns .....	16
Typical Chromaticity Characteristics .....	20
Emitter Pocket Tape Packaging .....	21
Emitter Reel Packaging .....	22
Product Binning and Labeling .....	23
Luminous Flux Bins .....	24
Radiometric Flux Bins .....	25
Forward Voltage Bins .....	26
Color Bins .....	27

# General Information

## Product Nomenclature

LUXEON Rebel ES Lime is tested at 350 mA/85°C. LUXEON Rebel ES Royal Blue and Blue are tested at 700 mA/25°C. All other LUXEON Rebel Color emitters are tested at 350 mA/25°C.

The part number designation is explained as follows:

L X M L - A B C D - E F G H

L X M 2 - A B C D - E F G H

L X M 3 - A B C D - E F G H

Where:

A — designates radiation pattern (value P for lambertian)

B — designates color (see LUXEON Rebel color binning and labeling section)

C — designates color variant (0 for color variants)

D — designates diode size (1 for 1mm<sup>2</sup> ; 2 for 2mm<sup>2</sup>)

EFGH — minimum luminous flux (lm) or radiometric power (mW) performance

## Average Lumen Maintenance Characteristics

LUXEON Rebel color emitters are tested and binned at 350 mA and LUXEON Rebel ES color emitters at 700 mA, with current pulse duration of 20 ms. All characteristic charts where the thermal pad is kept at constant temperature are measured with current pulse duration of 20 ms. Under these conditions, junction temperature and thermal pad temperature are the same.

Philips Lumileds projects that green, cyan, blue and all royal blue LUXEON Rebel color products will deliver, on average, 70% lumen maintenance (B50, L70) at 50,000 hours of operation at a forward current of 700 mA. This projection is based on constant current operation with junction temperature maintained at or below 135°C. Red, red-orange and amber LUXEON Rebel color products will also deliver, on average, 70% lumen maintenance (B50, L70) at 50,000 hours of operation at a forward current of 350 mA and is based on constant current operation with junction temperature maintained at or below 110°C. LUXEON Rebel PC amber delivers, on average, 70% lumen maintenance (L70) at 50,000 hours of operation at a forward current of up to 700 mA. This projection is based on constant current operation with junction temperature maintained at or below 130°C.

This performance is based on independent test data, Philips Lumileds historical data from tests run on similar material systems, and internal LUXEON Rebel reliability testing. Observation of design limits included in this data sheet is required in order to achieve this projected lumen maintenance.

## Environmental Compliance

Philips Lumileds is committed to providing environmentally friendly products to the solid-state lighting market. LUXEON Rebel and LUXEON Rebel ES color products are compliant to the European Union directives on the restriction of hazardous substances in electronic equipment, namely REACH and the RoHS directive. Philips Lumileds will not intentionally add the following restricted materials to the LUXEON Rebel Color Portfolio: lead, mercury, cadmium, hexavalent chromium, polybrominated biphenyls (PBB) or polybrominated diphenyl ethers (PBDE).

# Product Selection & Optical Characteristics

## Product Selection Guide for LUXEON Rebel and LUXEON Rebel ES Colors at Junction Temperature <sup>[3]</sup>

Table 1.

Color	Part Number	Performance @ 350 mA			Performance @ 700 mA		
		Minimum Luminous Flux (lm) or Radiometric Power (mW)	Typical Luminous Flux (lm) or Radiometric Power (mW)	Typical Efficacy (lm/W) or Radiant Efficacy	Minimum Luminous Flux (lm) or Radiometric Power (mW)	Typical Luminous Flux (lm) or Radiometric Power (mW)	Typical Efficacy (lm/W) or Radiant Efficacy
Lime	LXML-PX02-0000	140	148	154	–	278	142
		150	157	163	–	295	151
		160	167	174	–	313	160
		170	174	181	–	327	167
		180	183	190	–	344	176
Green	LXML-PM01-0100	100	102	100	–	161	68
	LXML-PM01-0090	90	95	93	–	150	63
	LXML-PM01-0080	80	88	86	–	139	58
	LXML-PM01-0070	70	79	78	–	125	52
Cyan	LXML-PE01-0080	80	83	81	–	133	56
	LXML-PE01-0070	70	76	75	–	122	51
	LXML-PE01-0060	60	67	66	–	110	46
Blue	LXML-PB01-0040	40.0	41	38	–	70	29
	LXML-PB01-0030	30.0	35	33	–	58	24
	LXML-PB01-0023	23.5	28	26	–	48	20
	LXML-PB01-0018	18.1	22	21	–	38	16
	LXML-PB02	–	–	–	50	58	28
		–	–	–	60	67	32
		–	–	–	70	75	36
–	–	–	80	83	40		
Royal Blue	LXML-PR01-0500	500 mW	520 mW	48%	–	910 mW	40%
	LXML-PR01-0425	425 mW	480 mW	44%	–	840 mW	37%
	LXML-PR02-1100	–	–	–	1100 mW	1120 mW	53%
	LXML-PR02-1050	–	–	–	1050 mW	1070 mW	51%
	LXML-PR02-1000	–	–	–	1000 mW	1030 mW	49%
	LXML-PR02-0950	–	–	–	950 mW	970 mW	46%
	LXML-PR02-0900	–	–	–	900 mW	940 mW	44%
	LXML-PR02-0800	–	–	–	800 mW	890 mW	42%
	LXML-PR02-A900 <sup>1)</sup>	–	–	–	900 mW	1030 mW	49%
Deep Red	LXM3-PD01	350 mW	360 mW	46%	–	720 mW	42%
		300 mW	320 mW	41%	–	640 mW	38%
		260 mW	290 mW	37%	–	580 mW	34%
Red	LXM2-PD01-0060	60	62	83	–	119	74
	LXM2-PD01-0050	50	53	75	–	106	65
	LXM2-PD01-0040	40	48	65	–	90	56
	LXML-PD01-0050	50	52	53	–	85	35
	LXML-PD01-0040	40	46	47	–	75	30
	LXML-PD01-0030	30	38	37	–	62	24
Red-Orange	LXM2-PH01-0070	70	72	98	–	134	83
	LXM2-PH01-0060	60	67	91	–	122	76
	LXML-PH01-0060	60	62	63	–	100	40
	LXML-PH01-0050	50	56	57	–	90	35
PC Amber	LXM2-PL01-0000	110	112	105	–	198	96
		100	102	96	–	184	83
		90	95	89	–	171	76
		80	86	80	–	155	70
		70	78	73	–	140	63
Amber	LXML-PL01-0060	60	61	60	–	98	39
	LXML-PL01-0050	50	54	51	–	84	33
	LXML-PL01-0040	40	48	46	–	77	30
	LXML-PL01-0030	30	38	37	–	61	24

Notes for Table 1:

- LXML-PR02-A900 is a selection of color Bins 4,5 only.
- Minimum luminous flux or radiometric power performance guaranteed within published operating conditions. Philips Lumileds maintains a tolerance of  $\pm 6.5\%$  on flux and power measurements.
- LUXEON Rebel ES Lime is tested and binned at thermal pad temperature = 85°C, all other LUXEON Rebel Color emitters are tested and binned with thermal pad temperature = 25°C.
- LUXEON Rebel ES Lime, ES Blue, Deep Red and PC Amber may also be sold under part numbers which denote a minimum flux level, similar to other parts in the portfolio, specified by digits 9 through 12 of the part number.

## Flux Performance, Binning, and Supportability

LEDs are produced with semiconductor technology that is subject to process variation, yielding a range of flux performance that is approximately Gaussian in nature. In order to provide customers with fine granularity within the overall flux distribution, Philips Lumileds separates LEDs into fixed, easy to design with, minimum luminous flux bins. To verify supportability of parts chosen for your application design, please consult your Philips Lumileds sales representative.

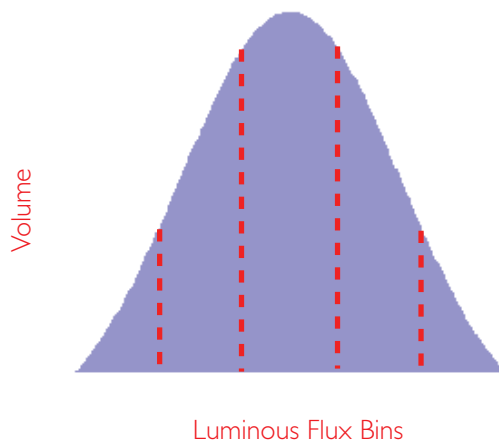

## Optical Characteristics

### LUXEON Rebel and LUXEON Rebel ES Colors at 350 mA or 700 mA, Test Temperature <sup>[1]</sup>

Table 2.

Color	Dominant Wavelength <sup>[2]</sup> $\lambda_D$ , or Peak Wavelength <sup>[3]</sup> $\lambda_p$			Typical Spectral Half-width <sup>[5]</sup> (nm) $\Delta\lambda_{1/2}$	Typical Temperature Coefficient of Dominant or Peak Wavelength (nm/°C) $\Delta\lambda_D / \Delta T_J$	Typical Total Included Angle <sup>[5]</sup> (degrees) $\theta_{0.90V}$	Typical Viewing Angle <sup>[6]</sup> (degrees) $2\theta_{1/2}$
	Minimum	Typical	Maximum				
Lime <sup>[7][9]</sup>	566.0 nm	567.5 nm	569.0 nm	100	0.01	160	125
Green <sup>[7]</sup>	520.0 nm	530.0 nm	540.0 nm	30	0.05	160	125
Cyan <sup>[7]</sup>	490.0 nm	505.0 nm	515.0 nm	30	0.04	160	125
Blue <sup>[7]</sup>	460.0 nm	470.0 nm	485.0 nm	20	0.05	160	125
Royal Blue <sup>[3][7]</sup>	440.0 nm	447.5 nm	460.0 nm	20	0.04	160	125
Red <sup>[8]</sup>	620.0 nm	627.0 nm	645.0 nm	20	0.05	160	125
Deep Red <sup>[3][8]</sup>	650.0 nm	655.0 nm	670.0 nm	20	0.05	160	125
Red-Orange <sup>[8]</sup>	610.0 nm	617.0 nm	620.0 nm	20	0.08	160	125
Amber <sup>[8]</sup>	584.5 nm	590.0 nm	594.5 nm	20	0.10	160	125
PC Amber <sup>[7][9]</sup>	587.8 nm	591.0 nm	592.0 nm	80	-0.01	160	120

Notes for Table 2:

- LXML-PR02-xxxx and LXML-PB02-xxxx emitters are tested and binned at 700 mA, all other LUXEON Rebel Color emitters are tested at 350 mA.
- Dominant wavelength is derived from the CIE 1931 Chromaticity diagram and represents the perceived color. Philips Lumileds maintains a tolerance of  $\pm 0.5$  nm for dominant wavelength measurements.
- Royal blue and deep red LEDs are binned by peak wavelength. Philips Lumileds maintains a tolerance of  $\pm 2$  nm for peak wavelength measurements.
- Spectral width at  $1/2$  of the peak intensity.
- Total angle at which 90% of total luminous flux or radiometric power is captured.
- Viewing angle is the off axis angle from lamp centerline where the luminous intensity is  $1/2$  of the peak value.
- Lime, PC Amber, green, cyan, blue and royal blue products are built with Indium Gallium Nitride (InGaN).
- All red, deep red, red-orange, and amber are built with Aluminum Indium Gallium Phosphide (AlInGaP).
- Lime and PC Amber are binned by chromaticity coordinates.

# Electrical Characteristics

## Electrical Characteristics for LUXEON Rebel and LUXEON Rebel ES Colors at Test Current and Temperature <sup>[1]</sup>

Table 3.

Color	Part Number	Forward Voltage $V_f$ (V)			Typical Temperature Coefficient of Forward Voltage <sup>[2]</sup> (mV/°C) $\Delta V_f / \Delta T_j$	Typical Thermal Resistance Junction to Thermal Pad (°C/W) $R\theta_{J-C}$
		Minimum	Typical	Maximum		
Lime	LXML-PX02	2.60	2.75	3.00	-2.0 to -4.0	6
Green	LXML-PM01	2.55	2.90	3.51	-2.0 to -4.0	10
Cyan	LXML-PE01	2.55	2.90	3.51	-2.0 to -4.0	10
Blue	LXML-PB02	2.50	2.95	3.50	-2.0 to -4.0	6
	LXML-PB01	2.55	2.95	3.51	-2.0 to -4.0	10
Royal Blue	LXML-PR02	2.50	2.90	3.50	-2.0 to -4.0	6
	LXML-PR01	2.55	2.95	3.51	-2.0 to -4.0	10
Red	LXML-PD01	2.31	2.90	3.51	-2.0 to -4.0	12
Red	LXM2-PD01	1.80	2.10	2.80	-2.0 to -4.0	8
Deep Red	LXM3-PD01	1.80	2.10	2.80	-2.0 to -4.0	8
Red-Orange	LXML-PH01	2.31	2.90	3.51	-2.0 to -4.0	12
Red-Orange	LXM2-PH01	1.80	2.10	2.80	-2.0 to -4.0	8
PC Amber	LXM2-PL01	2.55	3.05	3.51	-2.0 to -4.0	10
Amber	LXML-PL01	2.31	2.90	3.51	-2.0 to -4.0	12

Notes for Table 3:

- LUXEON Rebel ES Lime is tested at 350 mA/85°C. LUXEON Rebel ES Royal Blue and ES Blue are tested at 700 mA/25°C. All other LUXEON Rebel color emitters are tested at 350 mA/25°C.
- Measured between  $T_j = 25^\circ\text{C}$  and  $T_j = 110^\circ\text{C}$  at test current.
- Philips Lumileds maintains a tolerance of  $\pm 0.06\text{V}$  on forward voltage measurements.

## Absolute Maximum Ratings

Table 4.

Parameter	Green/Cyan/Blue/Royal Blue	ES Royal Blue/ES Blue/Lime	Red/Deep Red Red-Orange/Amber	PC Amber
DC Forward Current (mA)	1000	1000	700	700
Peak Pulsed Forward Current (mA)	1000	1200	700	700
Average Forward Current (mA)	1000	1000	700	700
ESD Sensitivity	< 8000V Human Body Model (HBM) Class 3A JESD22-A114-B			
LED Junction Temperature <sup>[1]</sup>	150°C	150°C	135°C	130°C
Operating Case Temperature	-40°C - 135°C	-40°C - 135°C	-40°C - 120°C	-40°C - 110°C
Storage Temperature	-40°C - 135°C	-40°C - 135°C	-40°C - 135°C	-40°C - 135°C
Soldering Temperature	JEDEC 020c 260°C	JEDEC 020c 260°C	JEDEC 020c 260°C	JEDEC 020c 260°C
Allowable Reflow Cycles	3	3	3	3
Autoclave Conditions	121°C at 2 ATM 100% Relative Humidity for 96 Hours Maximum			
Reverse Voltage (Vr)	LUXEON Rebel Color Portfolio LEDs are not designed to be driven in reverse bias.			

Notes for Table 4:

- Proper current derating must be observed to maintain junction temperature below the maximum.
- Pulsed operation of Rebel ES Colors with a peak drive current of 1200 mA is acceptable if the pulse on-time is  $\leq 5$  ms per cycle and the duty cycle is  $\leq 50\%$ .

## JEDEC Moisture Sensitivity

Table 5.

Level	Floor Life		Soak Requirements	
			Standard	
	Time	Conditions	Time	Conditions
1	unlimited	$\leq 30^\circ\text{C} / 85\% \text{ RH}$	168 Hrs. + 5 / -0 Hrs.	85°C / 85% RH

# Reflow Soldering Characteristics

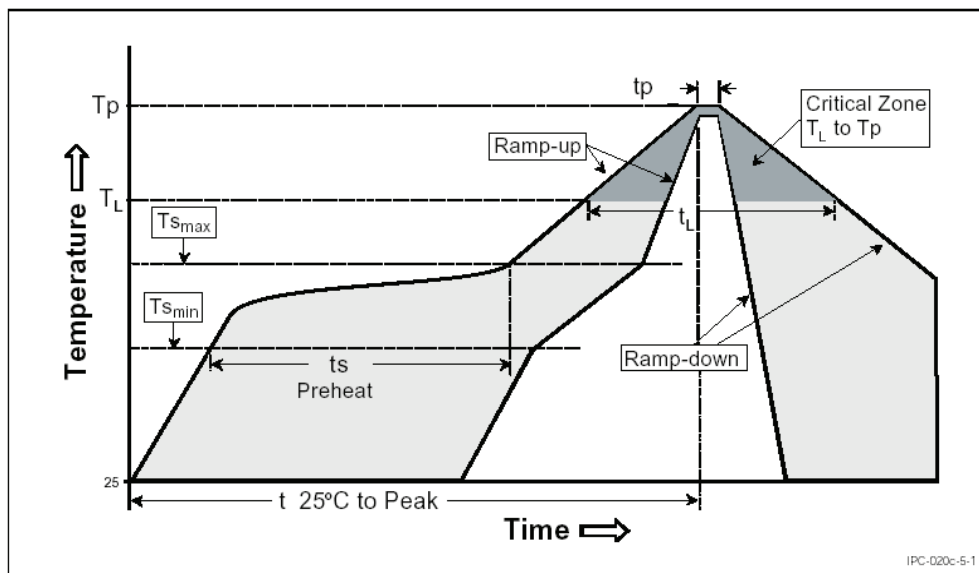

Temperature Profile for Table 6.

Table 6.

Profile Feature	Lead Free Assembly
Average Ramp-Up Rate ( $T_{s_{max}}$ to $T_p$ )	3°C / second max
Preheat Temperature Min ( $T_{s_{min}}$ )	150°C
Preheat Temperature Max ( $T_{s_{max}}$ )	200°C
Preheat Time ( $t_{s_{min}}$ to $t_{s_{max}}$ )	60 - 180 seconds
Temperature $T_L$ ( $t_L$ )	217°C
Time Maintained Above Temperature $T_L$ ( $t_L$ )	60 - 150 seconds
Peak / Classification Temperature ( $T_p$ )	260°C
Time Within 5°C of Actual Peak Temperature ( $t_p$ )	20 - 40 seconds
Ramp-Down Rate	6°C / second max
Time 25°C to Peak Temperature	8 minutes max

Note for Table 6:

1. All temperatures refer to the application Printed Circuit Board (PCB), measured on the surface adjacent to the package body.



# Mechanical Dimensions

## LUXEON Rebel Color

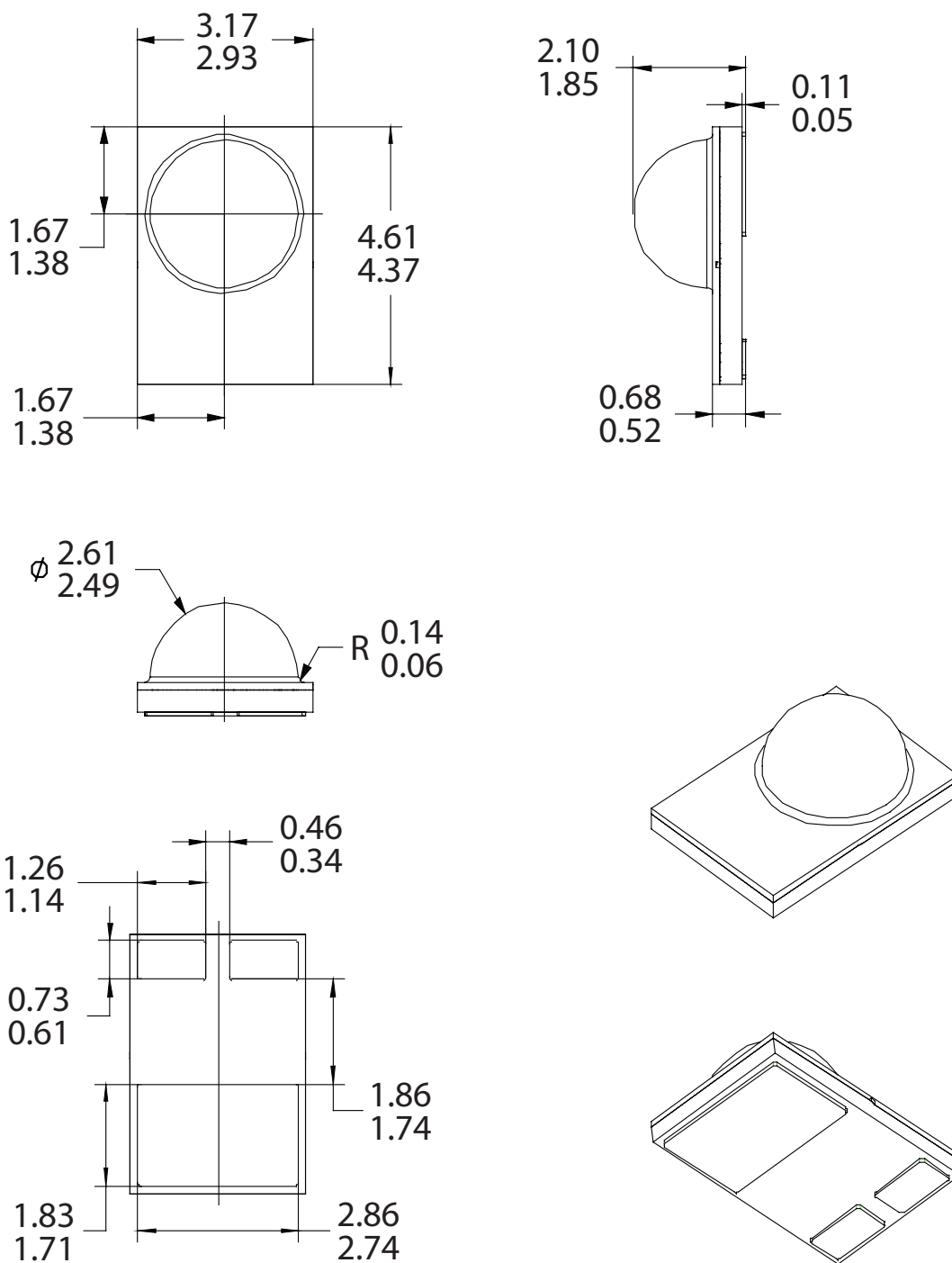

Figure 1. Package outline drawing.

Notes for Figure 1:

1. To avoid damage, do not handle the device by the emitter lens.
2. Drawings not to scale.
3. All dimensions are in millimeters.
4. The thermal pad is electrically isolated from the anode and cathode contact pads.

# Mechanical Dimensions

## LUXEON Rebel ES Color

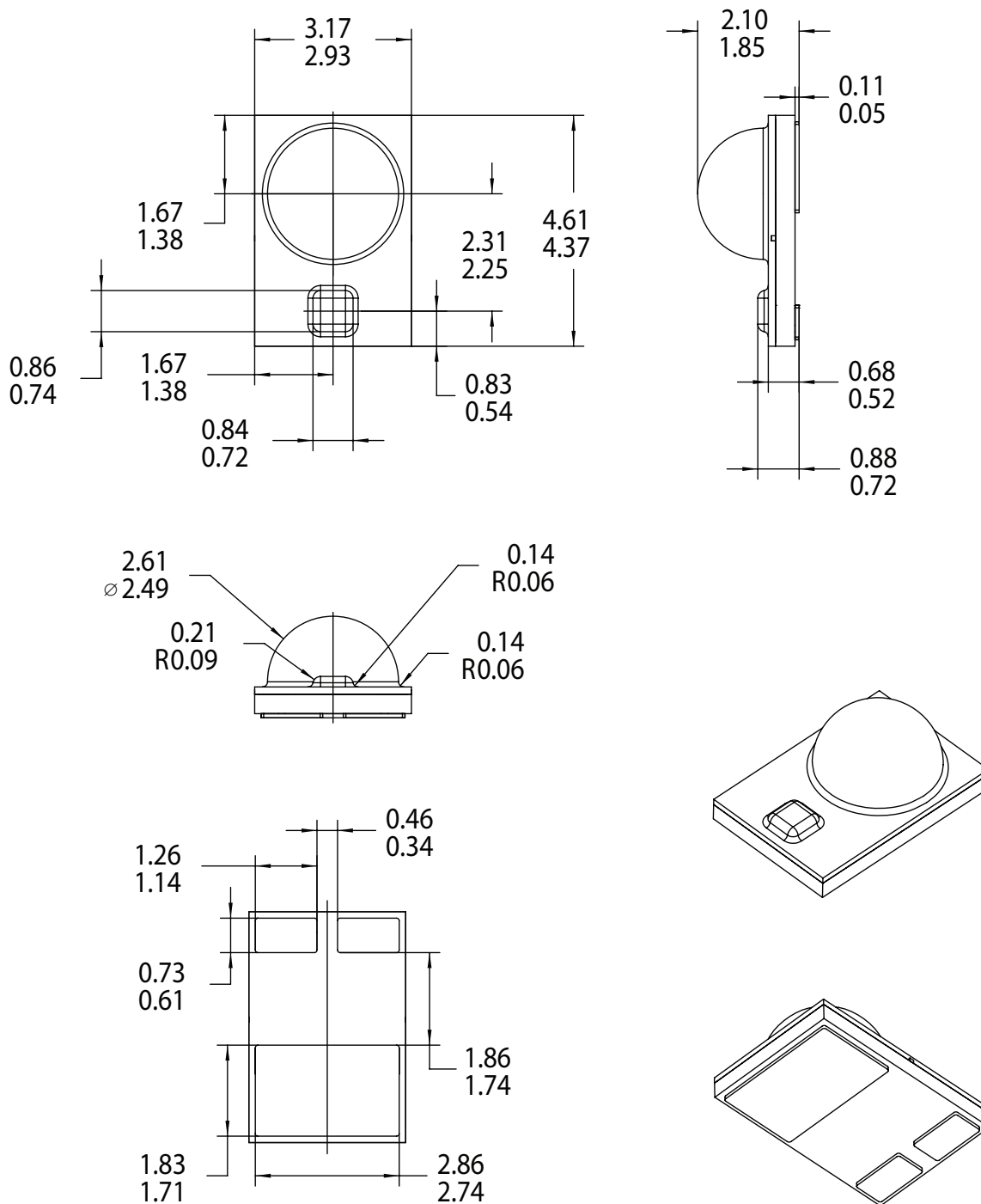

Figure 2. Package outline drawing.

### Notes for Figure 2:

1. To avoid damage, do not handle the device by the emitter lens.
2. Drawings not to scale.
3. All dimensions are in millimeters.
4. The thermal pad is electrically isolated from the anode and cathode contact pads.

## Pad Configuration

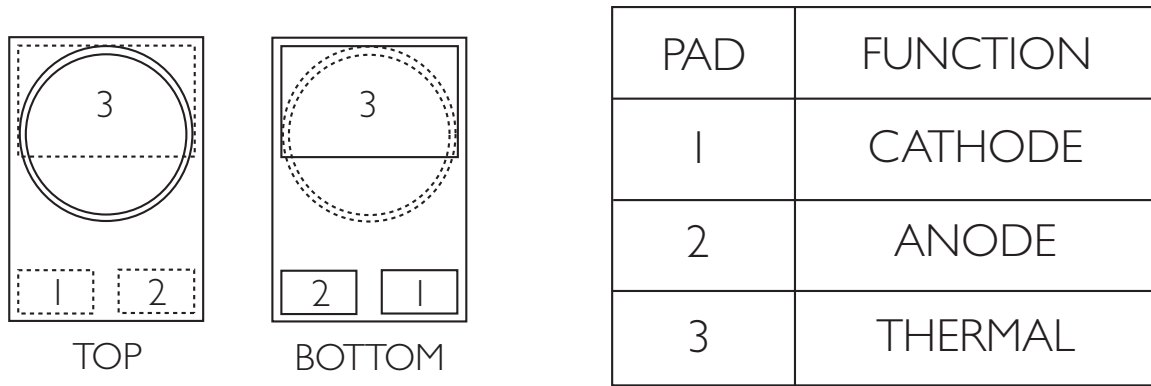

Figure 3. Solder pad layout.

Note for Figure 3:

1. The Thermal Pad is electrically isolated from the Anode and Cathode contact pads.

## Solder Pad Design

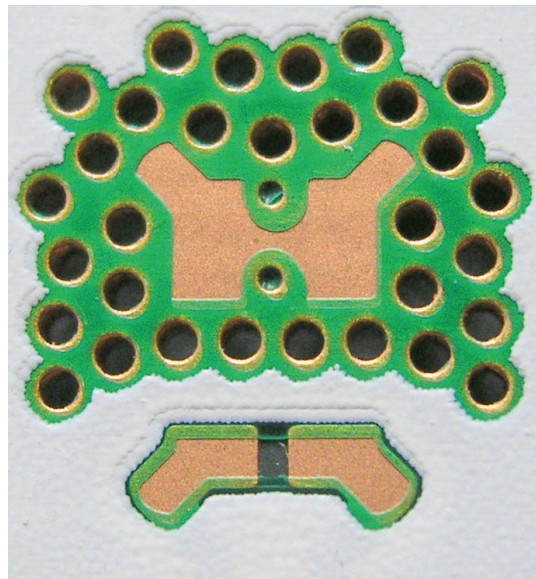

Figure 4. Solder pad layout.

Note for Figure 4:

1. The photograph shows the recommended LUXEON Rebel Color Portfolio layout on printed circuit board (PCB). This design easily achieves a thermal resistance of 7K/W.

Application Brief AB32 provides extensive details for this layout. In addition, the .dwg files are available at [www.philipslumileds.com](http://www.philipslumileds.com).

# Wavelength Characteristics

LUXEON Rebel Green, Cyan, Blue, Royal Blue, Red, Red-Orange, Amber at Test Current, 25°C

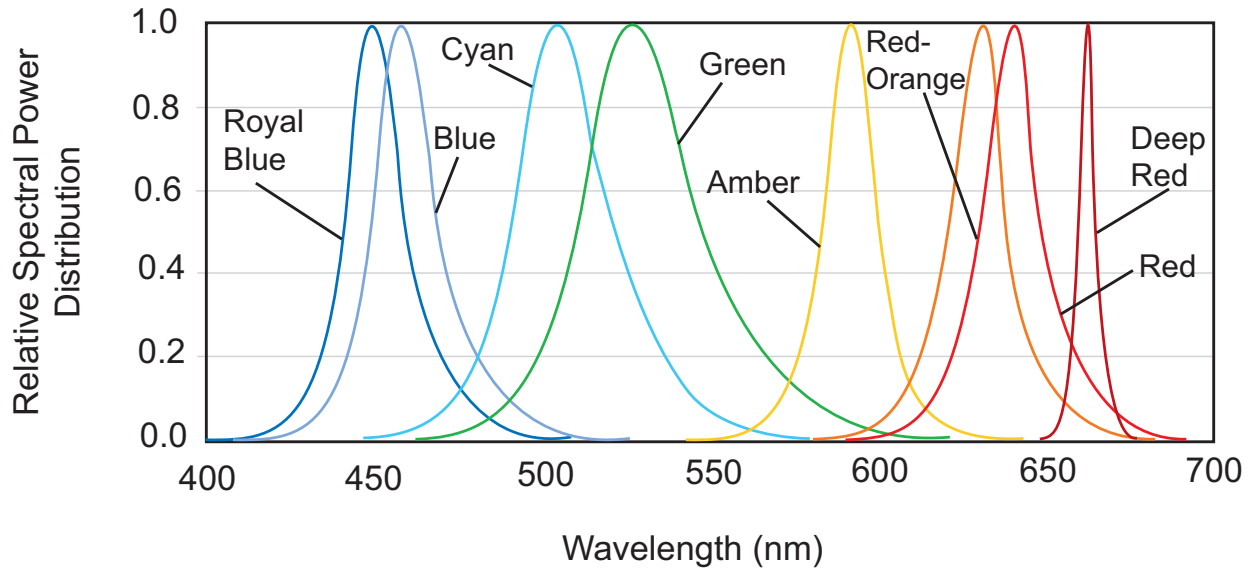

Figure 5. Relative intensity vs. wavelength.

LUXEON Rebel ES Lime and LUXEON Rebel PC Amber at 350 mA, 25°C or 85°C

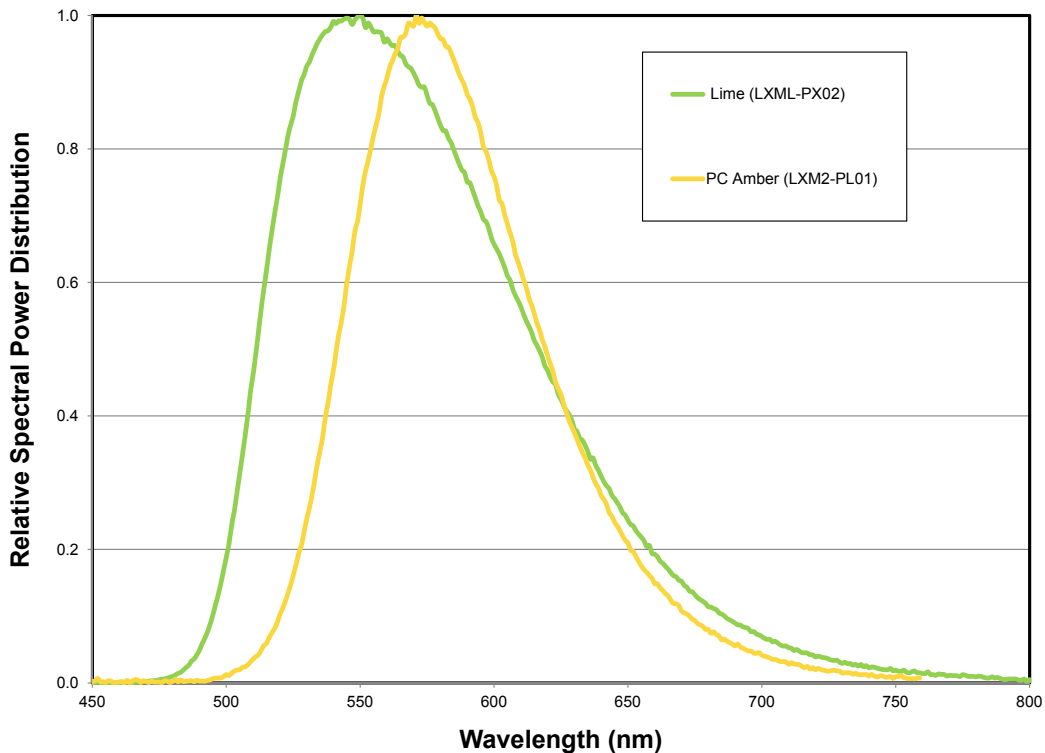
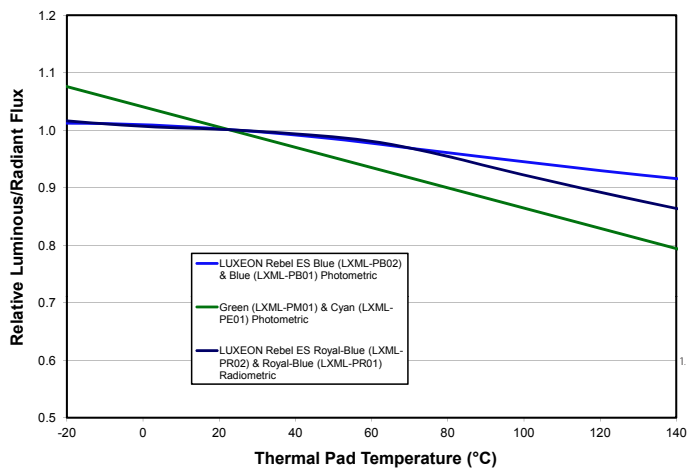

Figure 6. Relative intensity vs. wavelength.

# Typical Light Output Characteristics



\*LXML-PR02 and LXML-PB02 values are based on 700 mA drive current.

Figure 7. Relative light output vs. thermal pad temperature for green, cyan, blue and royal blue.

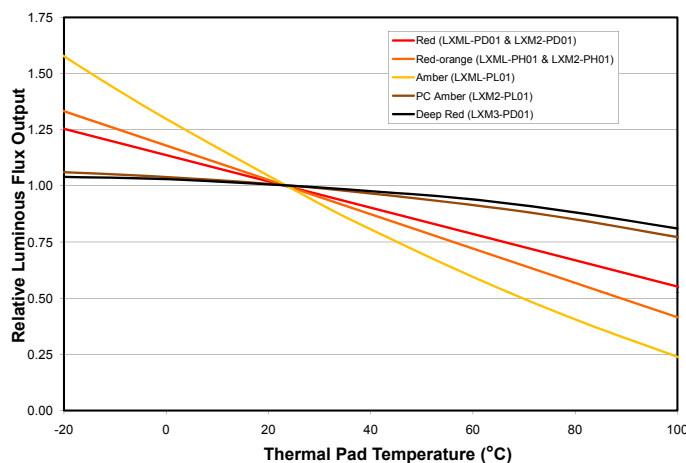

Figure 8. Relative light output vs. thermal pad temperature for red, deep red, red-orange and amber.

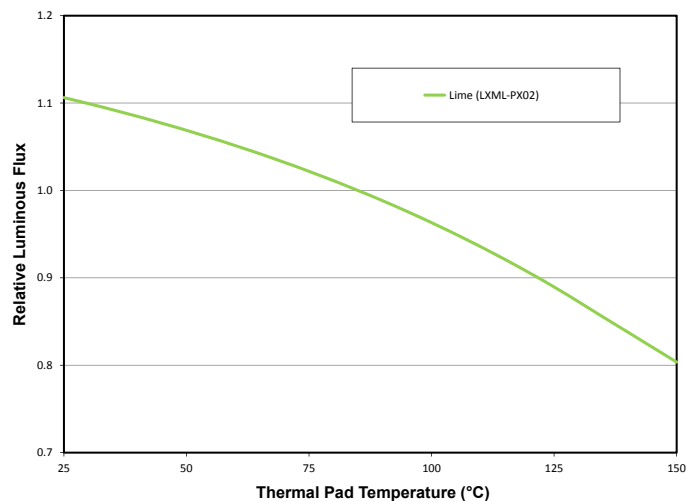

Figure 9. Relative light output vs. thermal pad temperature for lime.

# Typical Forward Current Characteristics

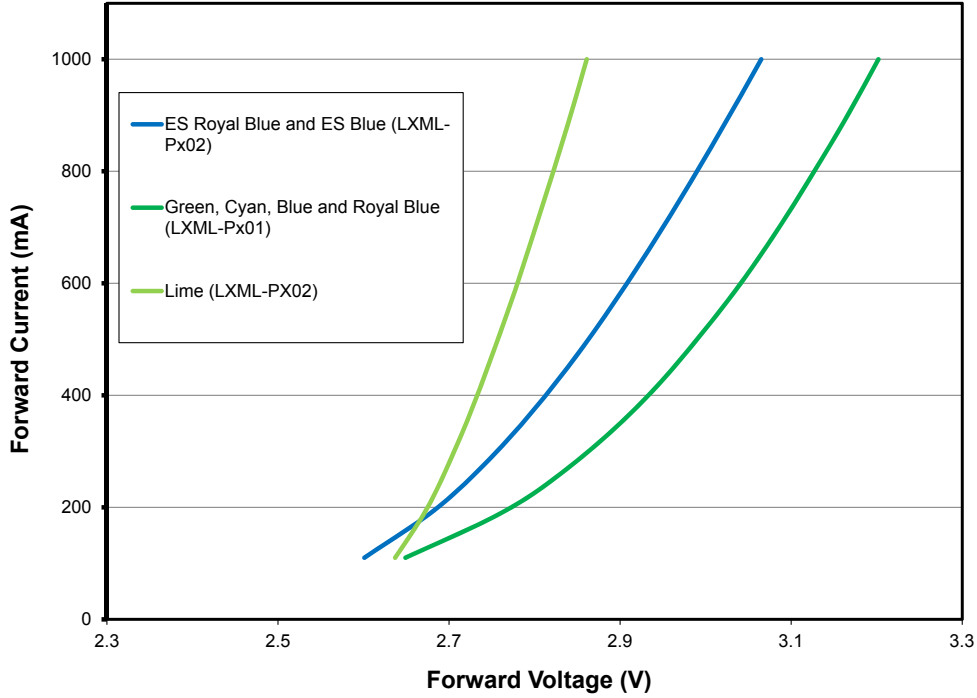

Figure 10. Forward current vs. forward voltage for green, cyan, blue and royal blue at test temperature = 25°C and lime at test temperature = 85°C.

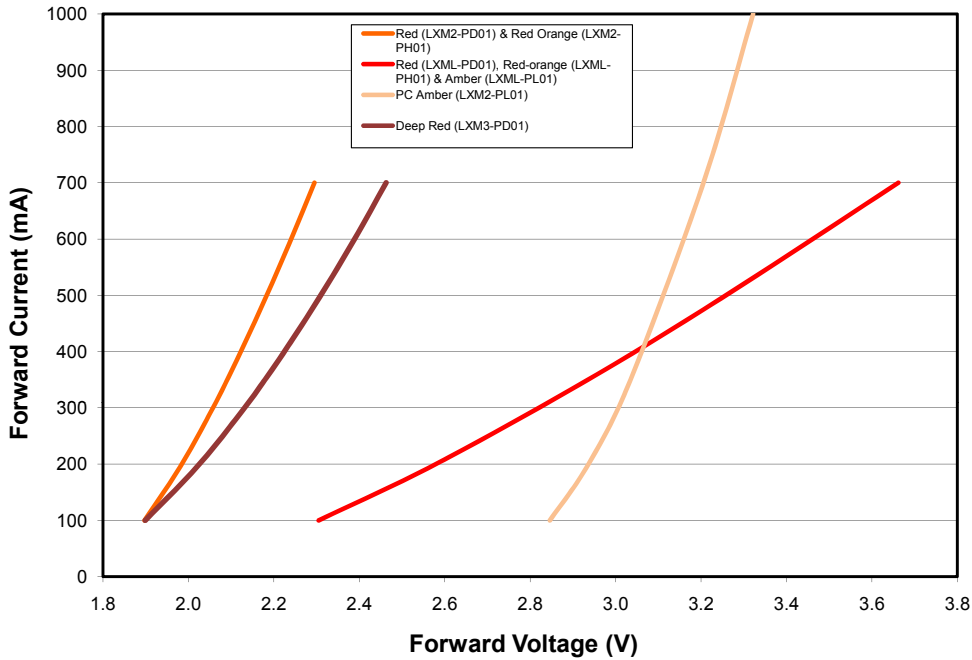

Figure 11. Forward current vs. forward voltage for red, deep red, red-orange, amber, and PC amber at thermal pad temperature = 25°C.

# Typical Relative Luminous Flux

## Relative Flux vs. Forward Current for LUXEON Rebel ES Royal Blue and Blue

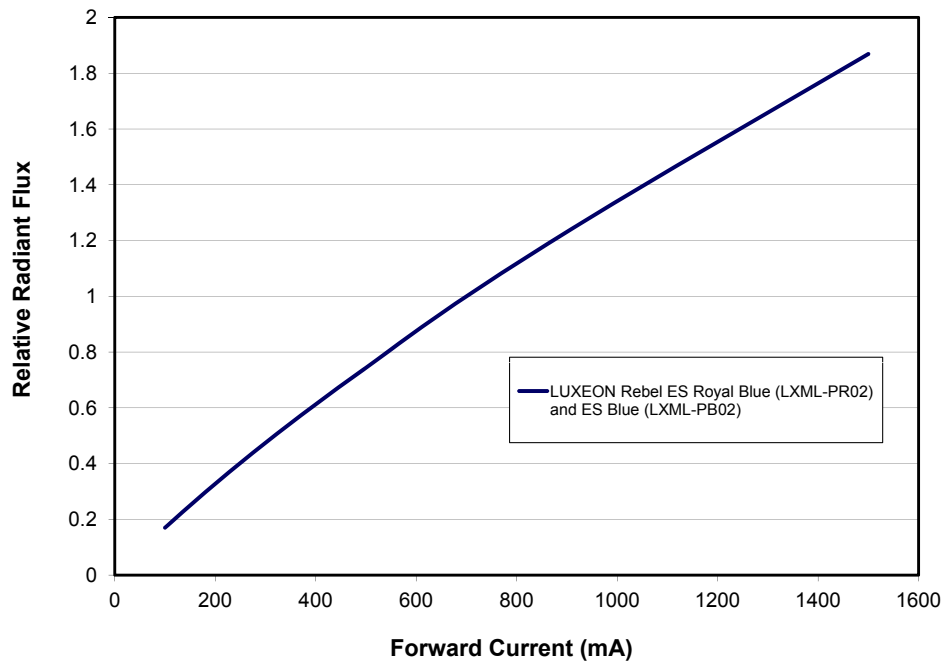

Figure 12. Relative luminous flux or radiometric power vs. forward current for Rebel ES Royal Blue and ES Blue at thermal pad temperature = 25°C.

## Relative Luminous Flux vs. Forward Current for LUXEON Rebel ES Lime and LUXEON Rebel Green, Cyan, Blue and Royal Blue

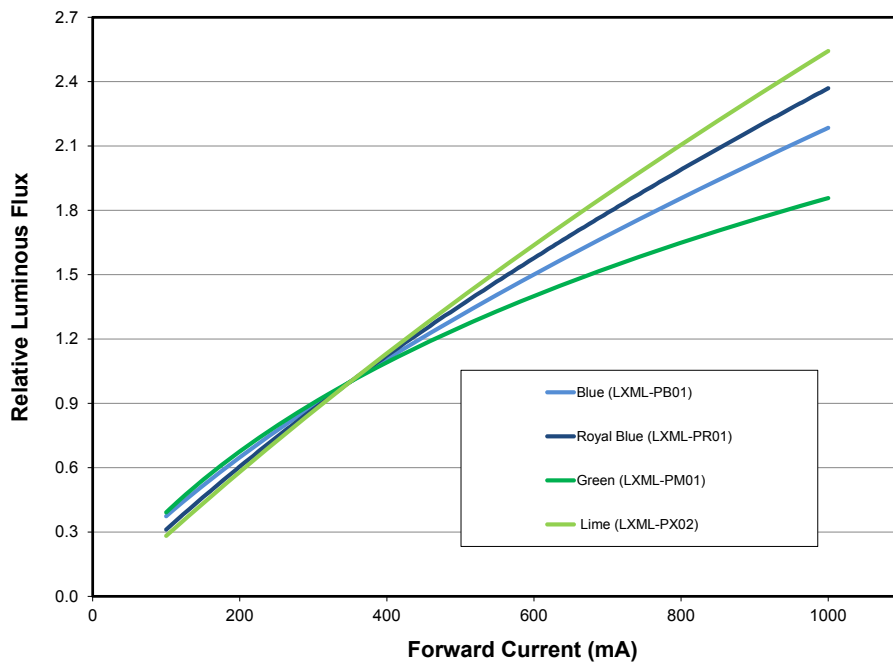

Figure 13. Relative luminous flux or radiometric power vs. forward current for green, cyan, blue and royal blue at thermal pad temperature = 25°C and Rebel ES Lime at thermal pad temperature = 85°C.

Relative Luminous Flux vs. Forward Current for LUXEON Rebel Red, Deep Red, Red-Orange, Amber, Junction Temperature = 25°C

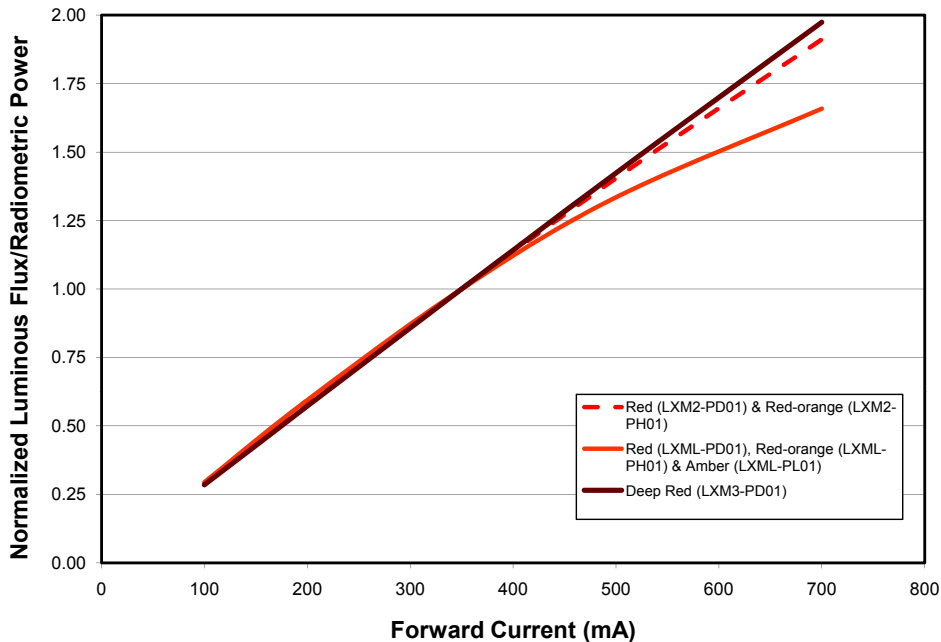

Figure 14. Relative luminous flux vs. forward current for red, deep red, red-orange and amber at Thermal Pad = 25°C maintained.

Relative Luminous Flux for LUXEON Rebel PC Amber Junction Temperature = 25°C

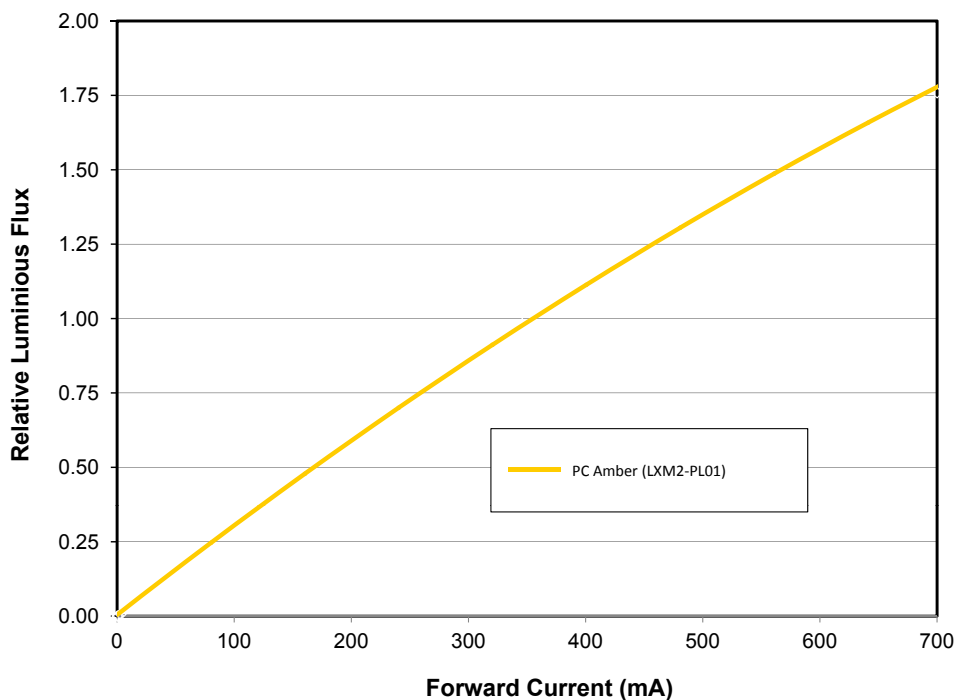

Figure 15. Relative luminous flux vs. forward current for PC amber LXM2-PL01 emitters.



# Typical Radiation Patterns

## Spatial Radiation Pattern for LUXEON Rebel Green, Cyan, Blue, Royal Blue and LUXEON Rebel ES Royal Blue and Blue

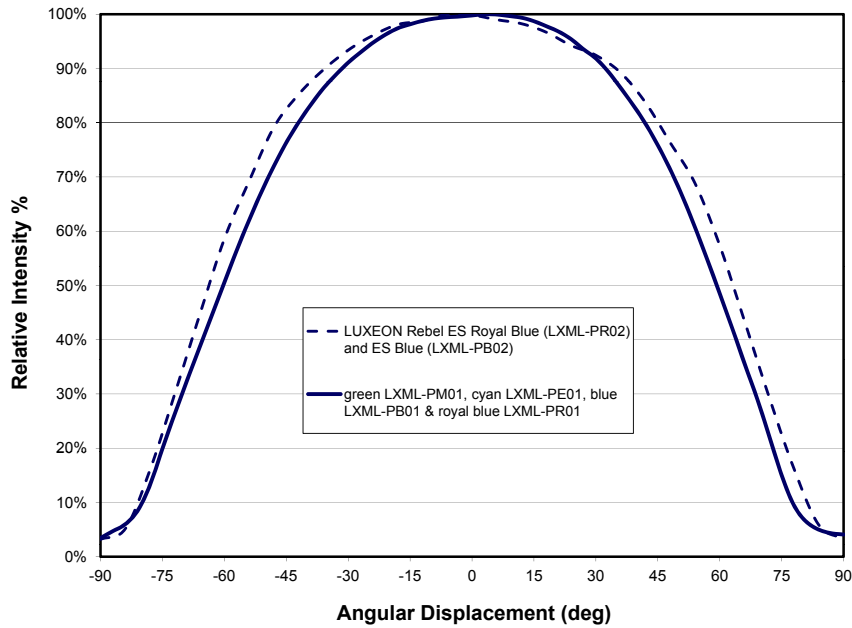

Figure 16. Spatial radiation pattern for LUXEON Rebel green, cyan, blue, royal blue, LUXEON Rebel ES Royal Blue and blue lambertian.

## Polar Radiation Pattern for LUXEON Rebel Green, Cyan, Blue, Royal Blue and LUXEON Rebel ES Royal Blue and Blue

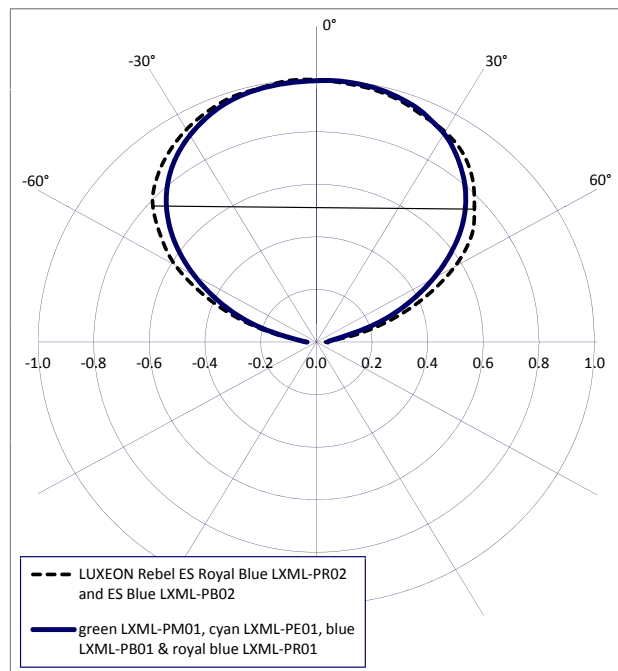

Figure 17. Polar radiation pattern for LUXEON Rebel green, cyan, blue, royal blue and LUXEON Rebel ES royal blue lambertian.

# Typical Radiation Patterns, Continued

## Spatial Radiation Pattern for LUXEON Rebel Red, Red-Orange and Amber

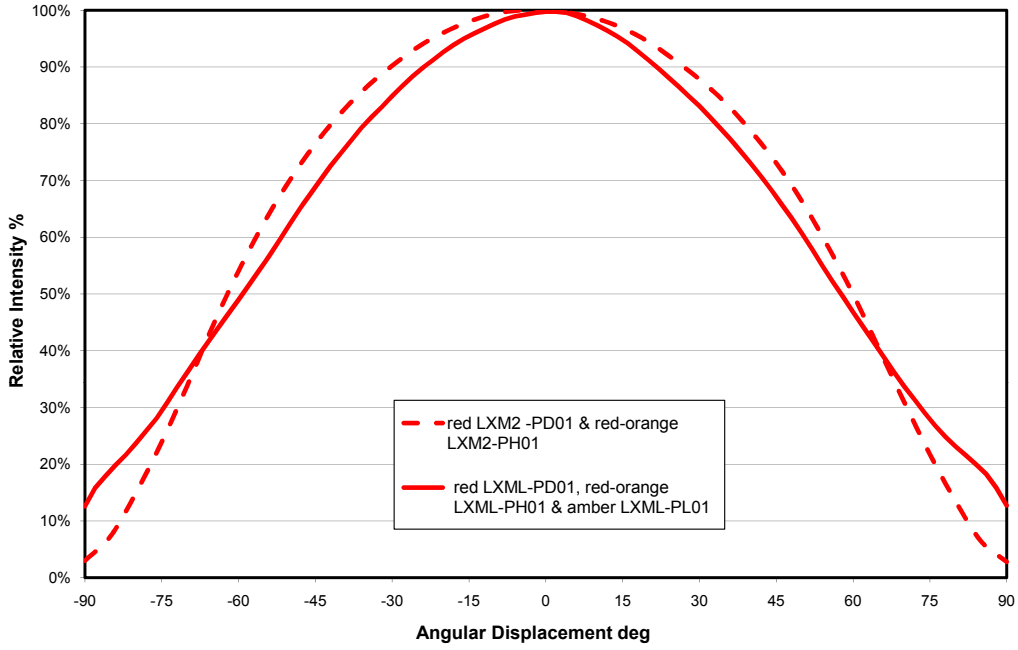

Figure 18. Spatial radiation pattern for red, red-orange and amber lambertian.

## Polar Radiation Pattern for LUXEON Rebel Red, Red-Orange and Amber

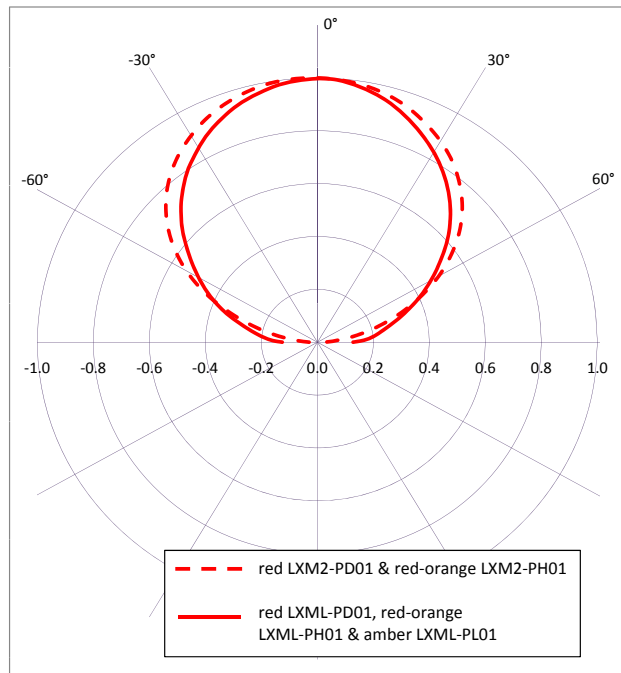

Figure 19. Polar radiation pattern for red, red-orange and amber lambertian.

# Typical Radiation Patterns, Continued

## Spatial Radiation Pattern for LUXEON Rebel Deep Red

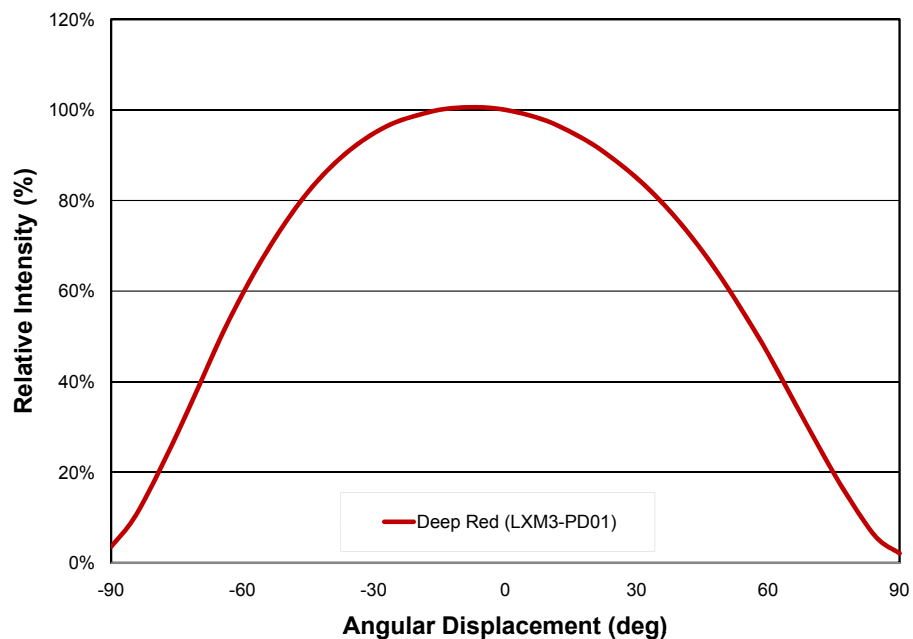

Figure 20. Spatial radiation pattern for deep red lambertian.

## Polar Radiation Pattern for LUXEON Rebel Deep Red

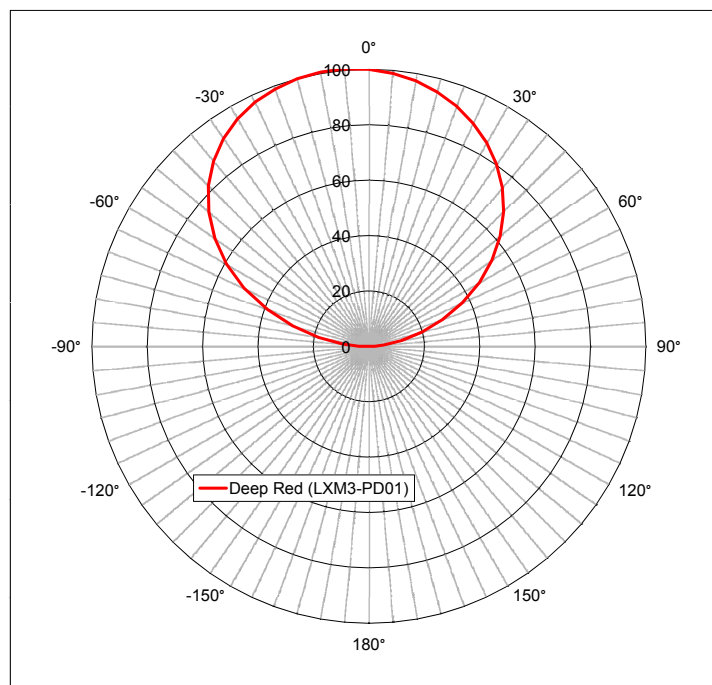

Figure 21. Polar radiation pattern for deep red lambertian.

# Typical Radiation Patterns, Continued

## Spatial Radiation Pattern for LUXEON Rebel PC Amber

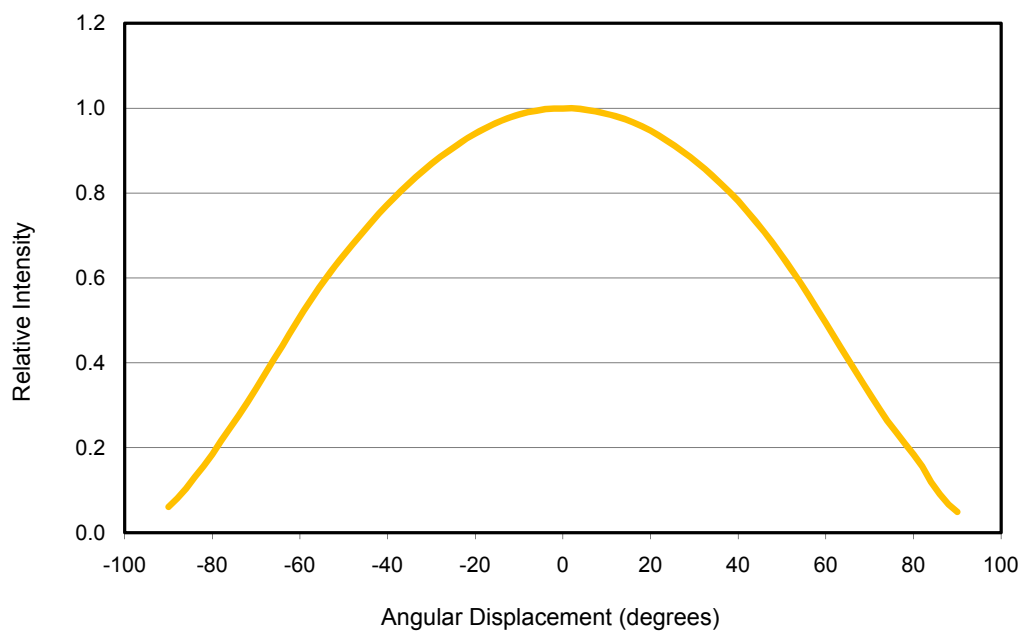

Figure 22. Spatial radiation pattern, PC amber, LXM2-PL01.

## Polar Radiation Pattern for LUXEON Rebel PC Amber

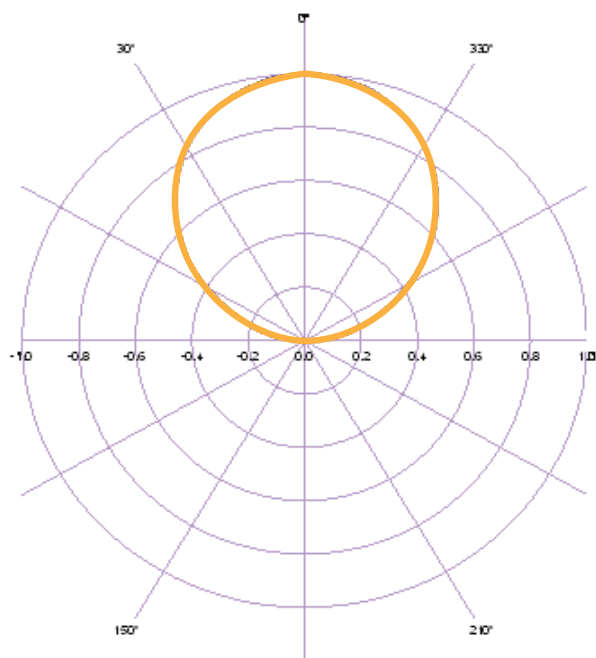

Figure 23. Polar radiation pattern, PC amber, LXM2-PL01.

# Typical Chromaticity Characteristics

## Chromaticity Characteristics vs. Temperature

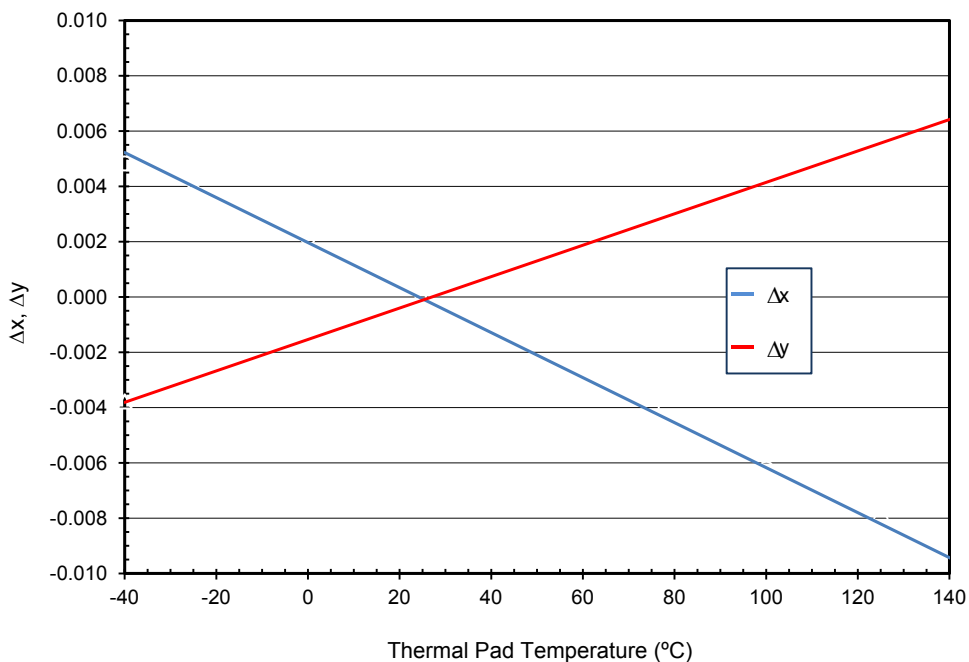

Figure 24. Chromaticity coordinate vs. thermal pad temperature. Test current: 350 mA.

## Chromaticity Characteristics vs. Forward Current, Junction Temperature = 25°C

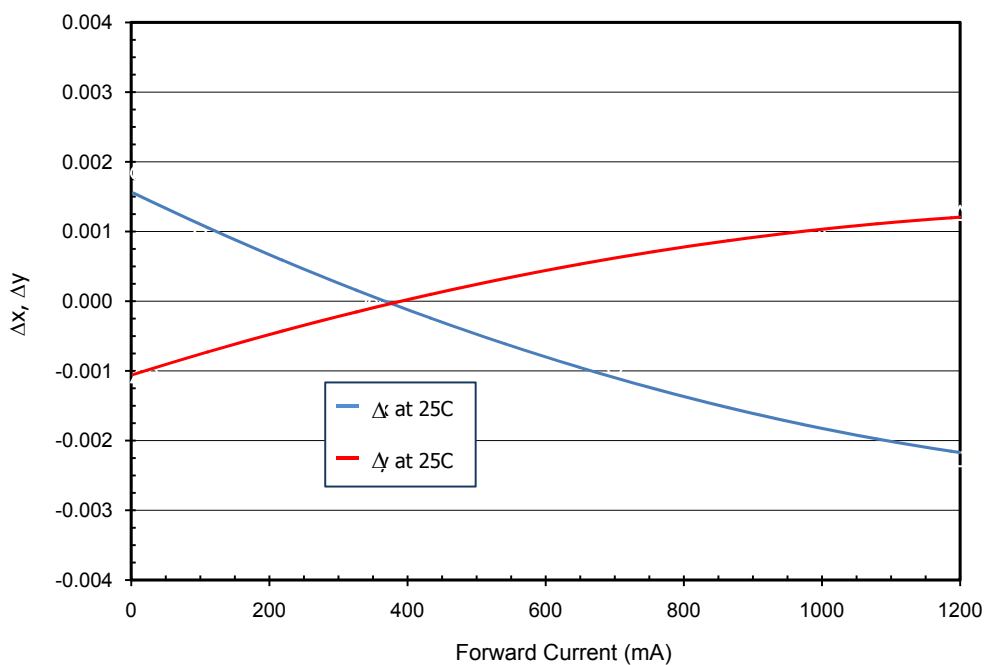

Figure 25. Chromaticity coordinate vs. forward current.

# Emitter Pocket Tape Packaging

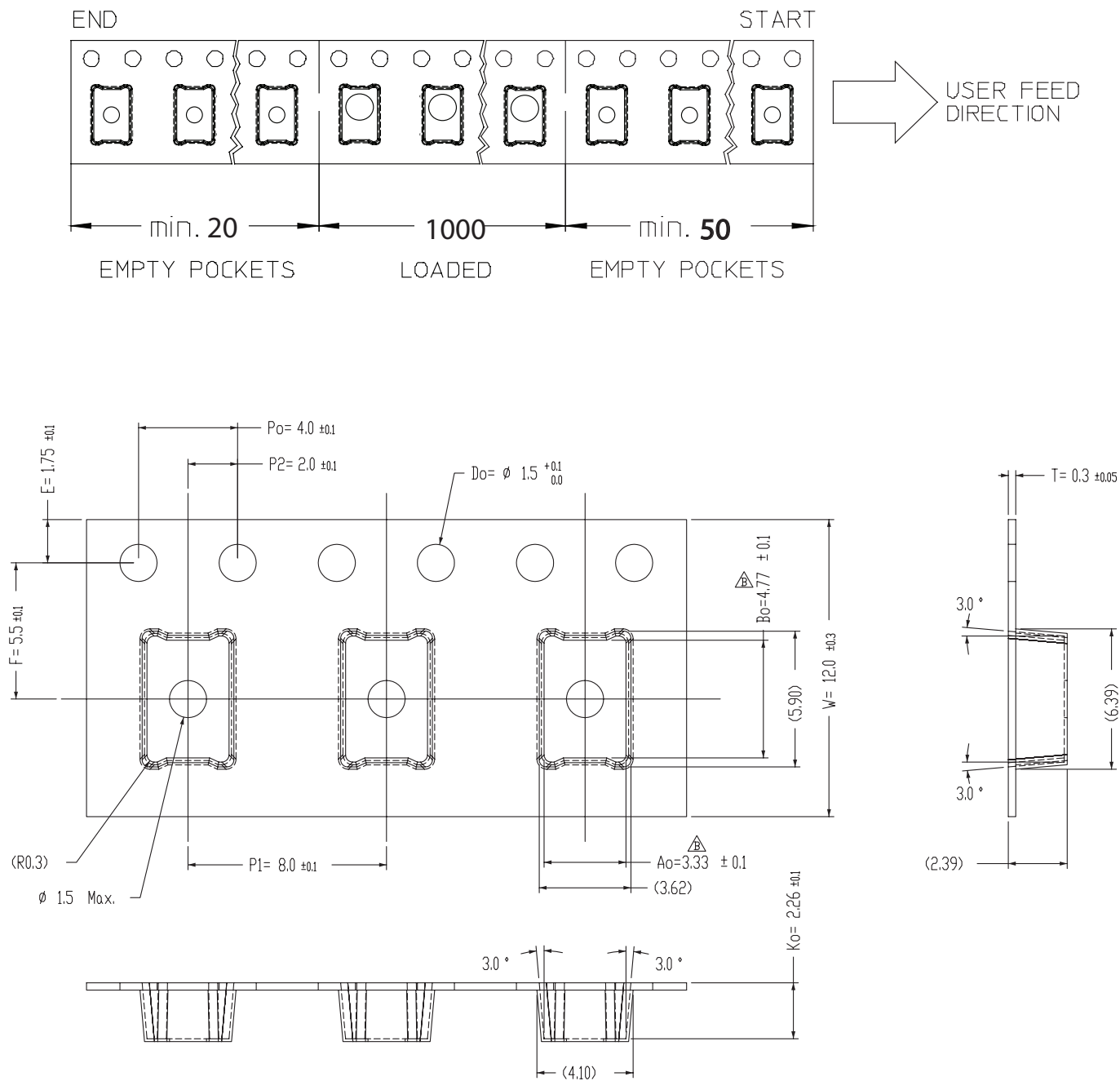

Figure 26. Emitter pocket tape packaging.

# Emitter Reel Packaging

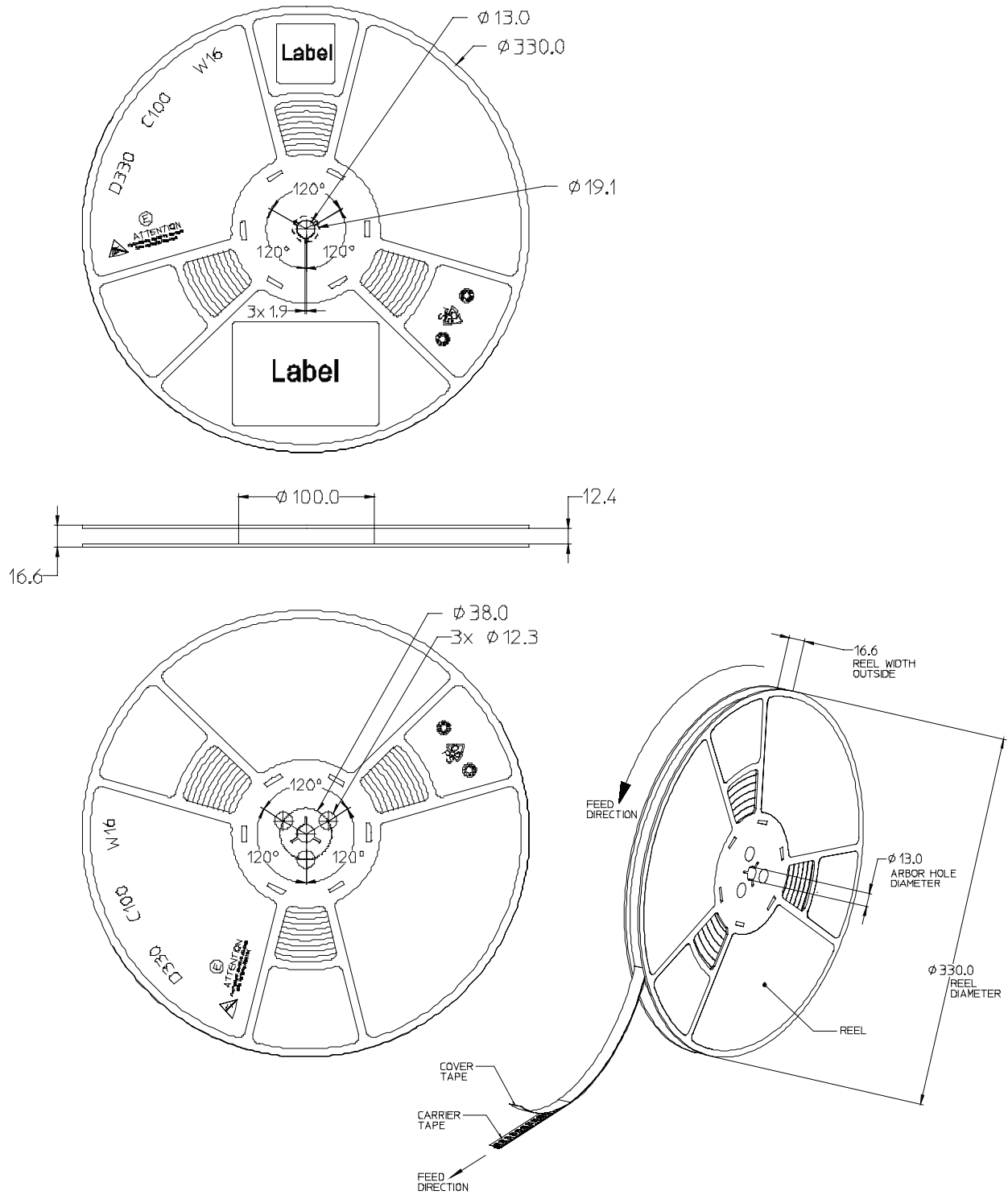

Figure 27. Emitter reel packaging.

# Product Binning and Labeling

## Purpose of Product Binning

In the manufacturing of semiconductor products, there is a variation of performance around the average values given in the technical data sheets. For this reason, Philips Lumileds bins the LED components for luminous flux, color and forward voltage ( $V_f$ ).

## Decoding Product Bin Labeling

LUXEON Rebel Color Portfolio emitters are labeled using a three or four digit alphanumeric code (CAT code) depicting the bin values for emitters packaged on a single reel. All emitters packaged within a reel are of the same 3-variable bin combination. Using these codes, it is possible to determine optimum mixing and matching of products for consistency in a given application.

## Format of Labeling for Emitters

Reels of green, cyan, blue, royal blue, red, red-orange, amber and PC amber emitters are labeled with a three digit alphanumeric CAT code following the format below.

ABC

A = Flux bin (J, K, L, M etc.)

B = Color bin (2, 4, 6 etc.)

C =  $V_f$  bin (D, E, F, G, etc.)

Reels of lime are labeled with the following CAT code format below.

ABCD

A = Flux bin (F, G, H, etc.)

BC = Color bin (A0)

D =  $V_f$  bin (P,R)



# Luminous Flux Bins

Tables 7 and 8 list the standard photometric luminous flux/radiometric power bins for LUXEON Rebel and LUXEON Rebel ES color emitters (tested and binned at different conditions). Although several bins are outlined, product availability in a particular bin varies by production run and by product performance. Not all bins are available in all colors.

**Table 7. Flux Bins - All Colors (except Royal Blue, Deep Red and Lime) -  $I_f = 350$  mA or 700 mA and  $T_j = 25^\circ\text{C}$**

Bin Code	Minimum Flux (lm)	Maximum Flux (lm)
D	18.1	23.5
E	23.5	30
F	30	40
G	40	50
H	50	60
J	60	70
K	70	80
L	80	90
M	90	100
N	100	110
X	110	120
P	120	130
Y	130	140

**Table 8. Flux Bins - LUXEON Rebel ES Lime at  $I_f = 350$  mA and  $T_j = 85^\circ\text{C}$**

Bin Code	Minimum Luminous Flux (lm)	Maximum Luminous Flux (lm)
E	140	150
F	150	160
G	160	170
H	170	180
J	180	190

# Radiometric Flux Bins

Table 9. Flux Bins - LUXEON Rebel Royal Blue ( $I_f = 350$  mA) and LUXEON Rebel ES Royal Blue ( $I_f = 700$  mA) at  $T_j = 25^\circ\text{C}$

Bin Code	Minimum Radiometric Flux (mW)	Maximum Radiometric Flux (mW)
D	350	425
E	425	500
F	500	600
G	600	700
H	700	800
J	800	900
K	900	950
Y	950	1000
A	1000	1050
B	1050	1100
M	1100	1200

Table 10. Flux Bins - LUXEON Rebel Deep Red at  $I_f = 350$  mA and  $T_j = 25^\circ\text{C}$

Bin Code	Minimum Radiometric Flux (mW)	Maximum Radiometric Flux (mW)
C	260	300
D	300	350
E	350	400

## Forward Voltage Bins

The following forward voltage bins include the minimum and maximum  $V_f$  bin values for the emitter. Although several bins are outlined, product availability in a particular bin varies by production run and by product performance.

**Table 11.  $V_f$  Bins - for LUXEON Rebel PC Amber (LXML-Pxx1 and LXM2-PL01) tested at  $I_f = 350$  mA**

Bin Code	Minimum Forward Voltage (V)	Maximum Forward Voltage (V)
A	2.31	2.55
B	2.55	2.79
C	2.79	3.03
D	3.03	3.27
E	3.27	3.51

**Table 12.  $V_f$  Bins - for LUXEON Rebel ES Royal Blue (LXML-PR02) and Blue (PXML-PB02) tested at  $I_f = 700$  mA**

Bin Code	Minimum Forward Voltage (V)	Maximum Forward Voltage (V)
P	2.50	2.75
R	2.75	3.00
S	3.00	3.25
T	3.25	3.50

**Table 13.  $V_f$  Bins - for LUXEON Rebel Red, Red Orange (LXM2-Pxx1) and Deep Red (PXM3-PD01) tested at 350 mA.**

Bin Code	Minimum Forward Voltage (V)	Maximum Forward Voltage (V)
V	1.80	2.00
W	2.00	2.20
X	2.20	2.40
Y	2.40	2.60
Z	2.60	2.80

**Table 14.  $V_f$  Bins - for LUXEON Rebel ES Lime (LXML-PX02) tested at  $I_f = 350$  mA.**

Bin Code	Minimum Forward Voltage (V)	Maximum Forward Voltage (V)
P	2.60	2.75
R	2.75	3.00

# Color Bins

Table 15. Dominant Wavelength Bin Structure for Green

Bin Code	Minimum Dominant Wavelength (nm)	Maximum Dominant Wavelength (nm)
1	520	525
2	525	530
3	530	535
4	535	540

Table 16. Dominant Wavelength Bin Structure for Cyan

Bin Code	Minimum Dominant Wavelength (nm)	Maximum Dominant Wavelength (nm)
1	490	495
2	495	500
3	500	505
4	505	510
5	510	515

Table 17. Dominant Wavelength Bin Structure for LUXEON Rebel and LUXEON Rebel ES Blue

Bin Code	Minimum Dominant Wavelength (nm)	Maximum Dominant Wavelength (nm)
1	460	465
2	465	470
3	470	475
4	475	480
5	480	485

Table 18. Peak Wavelength Bin Structure for LUXEON Rebel and LUXEON Rebel ES Royal Blue

Bin Code	Minimum Peak Wavelength (nm)	Maximum Peak Wavelength (nm)
3	440	445
4	445	450
5	450	455
6	455	460

## Color Bins, Continued

Table 19. Dominant Wavelength Bin Structure for Red

Bin Code	Minimum Dominant Wavelength (nm)	Maximum Dominant Wavelength (nm)
4	620	630
5	630	645

Table 20. Dominant Wavelength Bin Structure for Red-Orange

Bin Code	Minimum Dominant Wavelength (nm)	Maximum Dominant Wavelength (nm)
2	610	620

Table 21. Dominant Wavelength Bin Structure for Amber

Bin Code	Minimum Dominant Wavelength (nm)	Maximum Dominant Wavelength (nm)
1	585	587
2	587	590
4	590	592
6	592	595

Table 22. Peak Wavelength Bin Structure for Deep Red

Bin Code	Minimum Peak Wavelength (nm)	Maximum Peak Wavelength (nm)
6	650	660
7	660	670

# Color Bins for PC Amber and Lime

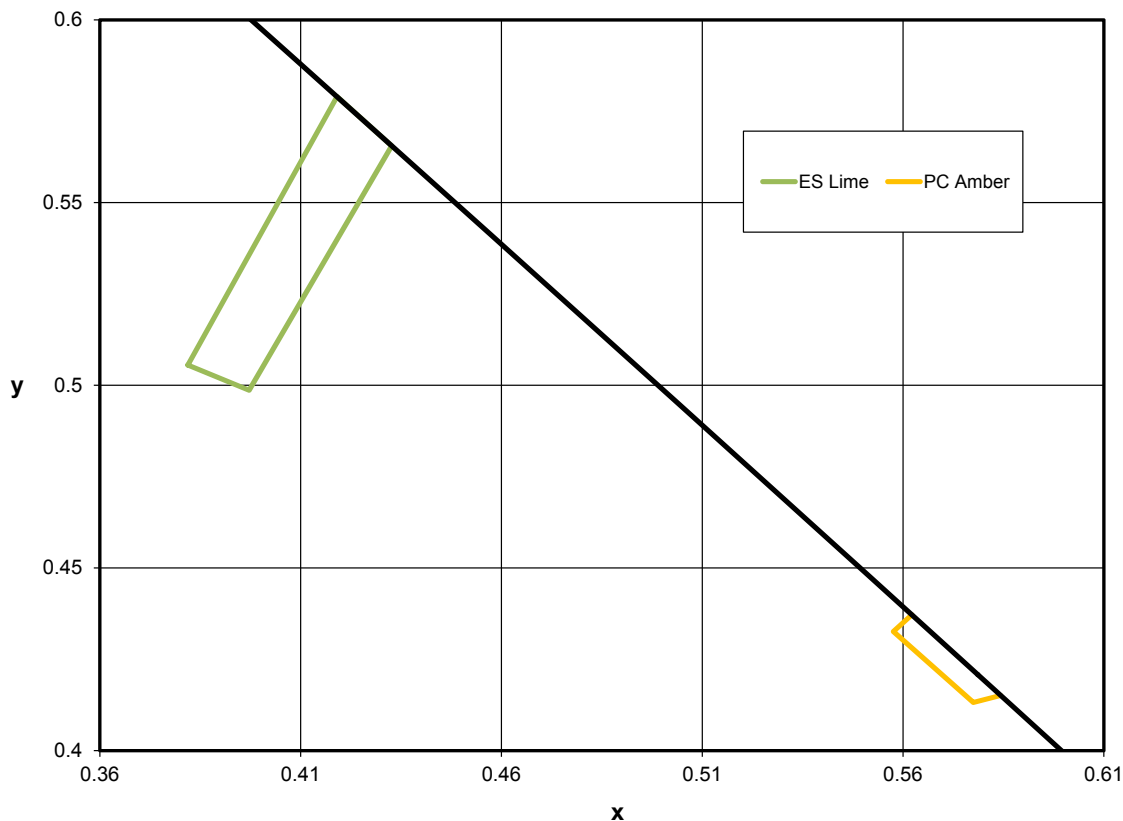

Figure 28. Color bin structure.

Table 23.

LUXEON Rebel PC Amber Bin Coordinates			
Bin Code	Bin Code	x	y
PC Amber	2	0.5622	0.4372
		0.5576	0.4326
		0.5775	0.4132
		0.5843	0.4151
Lime	A0	0.3819	0.5055
		0.4191	0.5790
		0.4327	0.5655
		0.3972	0.4986

Note for Table 23:

- LUXEON Rebel PC amber and lime emitters are tested and binned by x,y coordinates.

## Who We Are

Philips Lumileds focuses on one goal: Creating the world's highest performing LEDs. The company pioneered the use of solid-state lighting in breakthrough products such as the first LED backlit TV, the first LED flash in camera phones, and the first LED daytime running lights for cars. Today we offer the most comprehensive portfolio of high quality LEDs and uncompromising service.

Philips Lumileds brings LED's qualities of energy efficiency, digital control and long life to spotlights, downlights, high bay and low bay lighting, indoor area lighting, architectural and specialty lighting as well as retrofit lamps. Our products are engineered for optimal light quality and unprecedented efficacy at the lowest overall cost. By offering LEDs in chip, packaged and module form, we deliver supply chain flexibility to the inventors of next generation illumination.

Philips Lumileds understands that solid state lighting is not just about energy efficiency. It is about elegant design. Reinventing form. Engineering new materials. Pioneering markets and simplifying the supply chain. It's about a shared vision. Learn more about our comprehensive portfolio of LEDs at [www.philipslumileds.com](http://www.philipslumileds.com).

---

Philips Lumileds Lighting Company shall not be liable for any kind of loss of data or any other damages, direct, indirect or consequential, resulting from the use of the provided information and data. Although Philips Lumileds Lighting Company has attempted to provide the most accurate information and data, the materials and services information and data are provided "as is" and Philips Lumileds Lighting Company neither warranties, nor guarantees the contents and correctness of the provided information and data. Philips Lumileds Lighting Company reserves the right to make changes without notice. You as user agree to this disclaimer and user agreement with the download or use of the provided materials, information and data.

---



©2014 Philips Lumileds Lighting Company. All rights reserved.  
LUXEON is a registered trademark of the Philips Lumileds Lighting Company in the United States and other countries.

[www.philipslumileds.com](http://www.philipslumileds.com)  
[www.philipslumileds.cn.com](http://www.philipslumileds.cn.com)