

0603 AS

Engineer's Kit : EK-0603AS-X

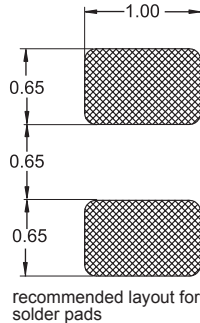

Single layer (typ)

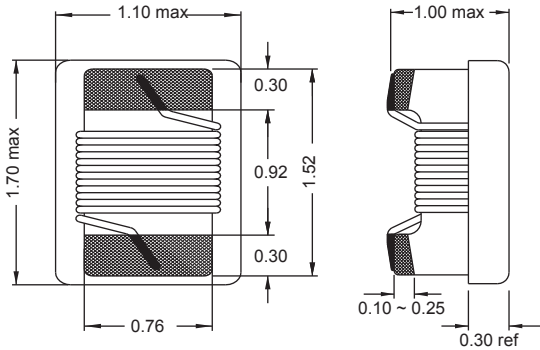
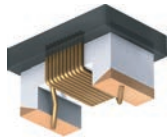
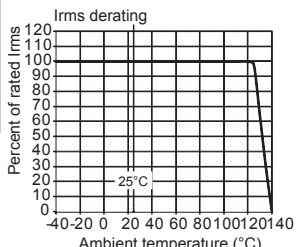

Current carrying capacity dependent on the ambient temperature

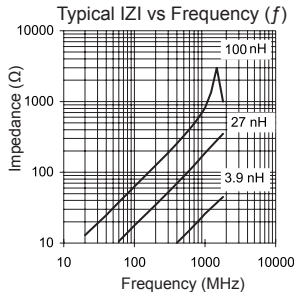
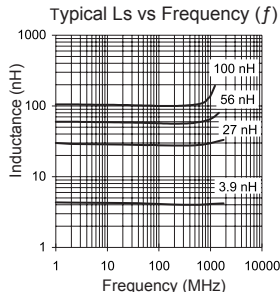
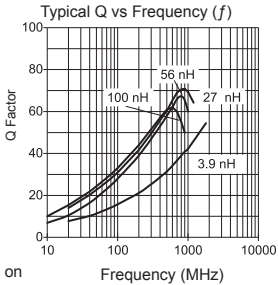

Part No	Inductance	f _L	Tol	Q	f _Q	SRF	DCR	Rated DC
	L (nH)	(MHz)	± (%)	min	(MHz)	(MHz)	max (Ω)	Current (mA)
0603AS-1N2M-YY	1.2	250	20	30	250	>6000 min	0.030	850
0603AS-1N3M-YY	1.3	250	20	30	250	>6000 min	0.030	850
0603AS-1N5K-YY	1.5	250	10	20	250	>6000 min	0.030	850
0603AS-1N6K-YY	1.6	250	10	20	250	>6000 min	0.030	850
0603AS-1N8K-YY	1.8	250	10	16	250	>6000 min	0.045	700
0603AS-2N0K-YY	2.0	250	10	10	250	5900 min	0.17	170
0603AS-2N2M-YY	2.2	250	20	10	250	5900 min	0.17	170
0603AS-3N3K-YY	3.3	250	10	22	250	6000 min	0.10	700
0603AS-3N6K-YY	3.6	250	10	20	250	>6000 min	0.08	700
0603AS-3N9K-YY	3.9	250	10	22	250	>6000 min	0.08	700
0603AS-4N3K-YY	4.3	250	10	25	250	>6000 min	0.07	700
0603AS-4N7K-YY	4.7	250	10	25	250	>6000 min	0.07	700
0603AS-5N1K-YY	5.1	250	10	20	250	>6000 min	0.10	700
0603AS-5N6K-YY	5.6	250	10	27	250	6000 min	0.12	700
0603AS-6N2J-YY	6.2	250	5	25	250	5800 min	0.11	700
0603AS-6N8J-YY	6.8	250	5	27	250	5800 min	0.11	700
0603AS-7N5J-YY	7.5	250	5	30	250	5400 min	0.12	700
0603AS-7N6J-YY	7.6	250	5	30	250	5400 min	0.12	700
0603AS-8N0J-YY	8.0	250	5	30	250	5400 min	0.12	700
0603AS-8N2J-YY	8.2	250	5	30	250	5400 min	0.12	700
0603AS-8N7J-YY	8.7	250	5	28	250	4600 min	0.109	700
0603AS-8N9J-YY	8.9	250	5	25	250	4600 min	0.19	700
0603AS-9N5J-YY	9.5	250	5	25	250	5000 min	0.19	700
0603AS-010J-YY	10	250	5	31	250	4800 min	0.13	700
0603AS-011J-YY	11	250	5	35	250	4000 min	0.13	700
0603AS-012J-YY	12	250	5	35	250	4000 min	0.13	700
0603AS-015J-YY	15	250	5	35	250	4000 min	0.17	700
0603AS-016J-YY	16	250	5	35	250	3200 min	0.17	700
0603AS-018J-YY	18	250	5	35	250	3100 min	0.17	700
0603AS-022J-YY	22	250	5	38	250	3000 min	0.19	700
0603AS-024J-YY	24	250	5	38	250	2800 min	0.22	600
0603AS-027J-YY	27	250	5	40	250	2800 min	0.22	600
0603AS-030J-YY	30	250	5	40	250	2300 min	0.22	600
0603AS-033J-YY	33	250	5	40	250	2300 min	0.22	600
0603AS-036J-YY	36	250	5	40	250	2200 min	0.25	600
0603AS-039J-YY	39	250	5	40	250	2200 min	0.25	600
0603AS-043J-YY	43	250	5	40	250	2000 min	0.28	600
0603AS-047J-YY	47	200	5	38	200	2000 min	0.28	600
0603AS-051J-YY	51	200	5	38	200	1900 min	0.28	600
0603AS-056J-YY	56	200	5	38	200	1900 min	0.31	400
0603AS-068J-YY	68	200	5	37	200	1700 min	0.34	400
0603AS-072J-YY	72	150	5	34	150	1700 min	0.49	400
0603AS-082J-YY	82	150	5	34	150	1700 min	0.54	400
0603AS-090J-YY	90	150	5	34	150	1700 min	0.54	400
0603AS-R10J-YY	100	150	5	34	150	1400 min	0.58	400
0603AS-R11J-YY	110	150	5	34	150	1350 min	0.61	300
0603AS-R12J-YY	120	150	5	34	150	1300 min	0.65	300
0603AS-R13J-YY	130	150	5	32	150	1200 min	0.90	200
0603AS-R15J-YY	150	150	5	32	150	1200 min	0.90	200
0603AS-R18J-YY	180	100	5	32	100	1100 min	1.20	200
0603AS-R20J-YY	200	100	5	30	100	1100 min	1.55	200
0603AS-R22J-YY	220	100	5	30	100	1000 min	1.60	150
* 0603AS-R25J-YY	250	100	5	25	100	950 min	2.30	150
* 0603AS-R27J-YY	270	100	5	25	100	950 min	2.30	150
* 0603AS-R30J-YY	300	100	5	25	100	900 min	2.40	150
* 0603AS-R33J-YY	330	100	5	25	100	600 min	2.50	150
* 0603AS-R39K-YY	390	100	10	25	100	450 min	2.90	150
0603AS-R47K-YY	470	25	10	16	25	230 typ	2.80	150
0603AS-R56K-YY	560	25	10	16	25	150 typ	2.90	150
0603AS-R68K-YY	680	25	10	16	25	140 typ	3.00	140
0603AS-R75K-YY	750	25	10	16	25	320 typ	3.50	130
* 0603AS-R82K-YY	820	25	10	16	25	290 typ	3.70	120
* 0603AS-R91K-YY	910	25	10	16	25	140 typ	3.80	120
* 0603AS-1R0K-YY	1000	25	10	16	25	250 typ	4.00	110
* 0603AS-1R2K-YY	1200	25	10	16	25	140 typ	4.20	100

Core Material : Ceramic

SPQ : Taped / Reel 4000 [-01]
2000 [-08]
15000 [-04]

Remarks:

- For not listed inductance values please check availability with us.
- 2% and 5% tolerance available on request.
- All are AEC-Q200 Standard approved EXCEPT *.
- This series is also available as non-magnetic, part numbering ASM.