



touchMATRIX[®] Indicator PN350 PROFINET display device with touch screen and graphic display

Product features:

- Multi-function display with PROFINET interface
- Operating modes for displaying two process values and links of the two values (1+2, 1-2, 1x2, 1:2)
- PROFINET IO Device Conformance Class B
- Dual Port Ethernet with integrated switch
- Bright and high-contrast display with event dependent color variations
- Emulation of a 7-segment display inclusively icons and units
- Intuitive and easy parameterization by plain text and touch screen
- 3.78 x 1.89 inch (96 x 48 mm) norm panel housing and IP65 protection
- Optional switching outputs

Available options:

PN350: Basic unit with PROFINET-interface

- Option **AC:** Power supply 115 ... 230 VAC
- Option **AO:** 16 bit analog output, 4 control outputs, serial RS232 interface
- Option **AR:** 16 bit analog output, 4 control outputs, serial RS485 interface
- Option **CO:** 4 control outputs, serial RS232 interface
- Option **CR:** 4 control outputs, serial RS485 interface
- Option **RL:** 2 relay outputs

Options can be combined

Die deutsche Beschreibung ist verfügbar unter:
https://www.motrona.com/fileadmin/files/bedienungsanleitungen/Pn350_d.pdf



The English description is available at:
https://www.motrona.com/fileadmin/files/bedienungsanleitungen/Pn350_e.pdf



La description en français est disponible sur:
https://www.motrona.com/fileadmin/files/bedienungsanleitungen/Pn350_f.pdf



The operator software OS (freeware) is available at:
<https://www.motrona.com/en/support/software.html>

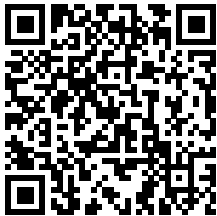

Version:	Description:
PN350_01a_oi/TJ/mbo/May 23	First Version

Legal notices:

All contents included in this manual are protected by the terms of use and copyrights of motrona GmbH. Any reproduction, modification, usage or publication in other electronic and printed media as well as in the internet requires prior written authorization by motrona GmbH.

Table of Contents

1.	Safety Instructions and Responsibility	5
1.1.	General Safety Instructions	5
1.2.	Use According to the Intended Purpose	5
1.3.	Installation	6
1.4.	EMC Guidelines	7
1.5.	Cleaning, Maintenance and Service Notes.....	7
2.	Introduction	8
2.1.	Operation Mode.....	8
2.2.	Function Diagram.....	9
3.	Electrical Connections	10
3.1.	DC Power Supply	10
3.2.	Auxiliary Voltage Output.....	10
3.3.	PROFINET Interface.....	11
3.3.1.	LEDs	11
3.3.2.	PROFINET-Configuration.....	11
3.3.3.	Process Data	12
3.3.4.	Acyclic Data Exchange	12
3.4.	Control Inputs.....	13
3.5.	Analog Output (Option AO/AR).....	13
3.6.	Serial Interface (Option AO/AR/CO/CR).....	14
3.7.	Control Outputs (Option AO/AR/CO/CR)	14
3.8.	AC Power Supply (Option AC).....	15
3.9.	Relay Outputs (Option RL).....	15
4.	Display and Touch Screen	16
4.1.	Screen Structure for Parameterization.....	16
4.2.	Screen Structure in Operation	17
4.3.	Error Messages.....	18
5.	Parameter / Overview – Menu Structure	20
5.1.	General Menu	22
5.2.	Fieldbus Properties	23
5.3.	Linkage Properties	27
5.4.	Preselection Values	28
5.5.	Preselection 1 Menu.....	29
5.6.	Preselection 2 Menu.....	31
5.7.	Preselection 3 Menu.....	32
5.8.	Preselection 4 Menu.....	33
5.9.	Serial Menu	34
5.10.	Analog Menu	36
5.11.	Command Menu.....	37
5.12.	Display Menu.....	39
6.	Appendix	41
6.1.	Data Readout via Serial Interface	41
6.2.	Parameter/ Indices and Serial Codes	42
6.2.1.	Commands:	45
6.2.2.	Status Words:.....	45

6.2.3. Variables (Actual values):..... 46
6.3. Dimensions 47
6.4. Technical Specifications..... 48

1. Safety Instructions and Responsibility

1.1. General Safety Instructions

This operation manual is a significant component of the unit and includes important rules and hints about the installation, function and usage. Non-observance can result in damage and/or impairment of the functions to the unit or the machine or even in injury to persons using the equipment!

Please read the following instructions carefully before operating the device and observe all safety and warning instructions! Keep the manual for later use.

A pertinent qualification of the respective staff is a fundamental requirement in order to use this manual. The unit must be installed, connected and put into operation by a qualified electrician.

Liability exclusion: The manufacturer is not liable for personal injury and/or damage to property and for consequential damage, due to incorrect handling, installation and operation. Further claims, due to errors in the operation manual as well as misinterpretations are excluded from liability.

In addition the manufacturer reserves the right to modify the hardware, software or operation manual at any time and without prior notice. Therefore, there might be minor differences between the unit and the descriptions in operation manual.

The raiser respectively positioner is exclusively responsible for the safety of the system and equipment where the unit will be integrated.

During installation or maintenance all general and also all country- and application-specific safety rules and standards must be observed.

If the device is used in processes, where a failure or faulty operation could damage the system or injure persons, appropriate precautions to avoid such consequences must be taken.

1.2. Use According to the Intended Purpose

The unit is intended exclusively for use in industrial machines, constructions and systems. Non-conforming usage does not correspond to the provisions and lies within the sole responsibility of the user. The manufacturer is not liable for damages which have arisen through unsuitable and improper use.

Please note that device may only be installed in proper form and used in a technically perfect condition (in accordance to the Technical Specifications). The device is not suitable for operation in explosion-proof areas or areas which are excluded by the EN 61010-1 standard.

1.3. Installation

The device is only allowed to be installed and operated within the permissible temperature range. Please ensure an adequate ventilation and avoid all direct contact between the device and hot or aggressive gases and liquids.

Before installation or maintenance, the unit must be disconnected from all voltage-sources. Further it must be ensured that no danger can arise by touching the disconnected voltage-sources.

Devices which are supplied by AC-voltages must be connected exclusively by switches, respectively circuit-breakers with the low voltage network. The switch or circuit-breaker must be placed as near as possible to the device and further indicated as separator.

Incoming as well as outgoing wires and wires for extra low voltages (ELV) must be separated from dangerous electrical cables (SELV circuits) by using a double resp. increased isolation.

All selected wires and isolations must be conformed to the provided voltage- and temperature-ranges. Further all country- and application-specific standards, which are relevant for structure, form and quality of the wires, must be ensured. Indications about the permissible wire cross-sections for wiring are described in the Technical Specifications.

Before first start-up it must be ensured that all connections and wires are firmly seated and secured in the screw terminals. All (inclusively unused) terminals must be fastened by turning the relevant screws clockwise up to the stop.

Overvoltages at the connections must be limited to values in accordance to the overvoltage category II.

1.4. EMC Guidelines

All motrona devices are designed to provide high protection against electromagnetic interference. Nevertheless you must minimize the influence of electromagnetic noise to the device and all connected cables.

Therefore the following measures are mandatory for a successful installation and operation:

- **Use shielded cables for all signal and control input and output lines.**
- **Cables for digital controls (digital I/O, relay outputs) must not exceed a length of 30 m and are allowed for in building operation only**
- Use shield connection clamps to connect the cable shields properly to earth
- The wiring of the common ground lines must be star-shaped and common ground must be connected to earth at only one single point
- The device should be mounted in a metal enclosure with sufficient distance to sources of electromagnetic noise.
- Run signal and control cables apart from power lines and other cables emitting electromagnetic noise.

Please also refer to motrona manual "General Rules for Cabling, Grounding, Cabinet Assembly". You can download that manual by the link

<https://www.motrona.com/en/support/general-certificates.html>

1.5. Cleaning, Maintenance and Service Notes

To clean the front of the unit please use only a slightly damp (not wet!), soft cloth. For the rear no cleaning is necessary. For an unscheduled, individual cleaning of the rear the maintenance staff or assembler is self-responsible.

During normal operation no maintenance is necessary. In case of unexpected problems, failures or malfunctions the device must be shipped for back to the manufacturer for checking, adjustment and reparation (if necessary). Unauthorized opening and repairing can have negative effects or failures to the protection-measures of the unit.

2. Introduction

This series of display unit is suitable for PROFINET and panel mounting.

Two process data values transmitted by the PROFINET controller can be scaled, linked and displayed. Due to the intuitive operation, the extensive functions and options, it can be used universally.

Basic knowledge of the function of PROFINET IO is required to commission the PROFINET display device and to understand these operating instructions.

2.1. Operation Mode

All functions are can be configured in the parameter menu.

Optionally the two process data values or the linked value can be displayed.

The type of link is set via the operating mode.

The following operating modes can be set:

- VALUE1 + VALUE2:
The linked value is the sum of the two process data values.
- VALUE1 – VALUE2:
The linked value is the difference of the two process data values.
- VALUE1 x VALUE2:
The linked value is the product of the two process data values.
- VALUE1 / VALUE2:
The linked value is the quotient of the two process data values.

2.2. Function Diagram

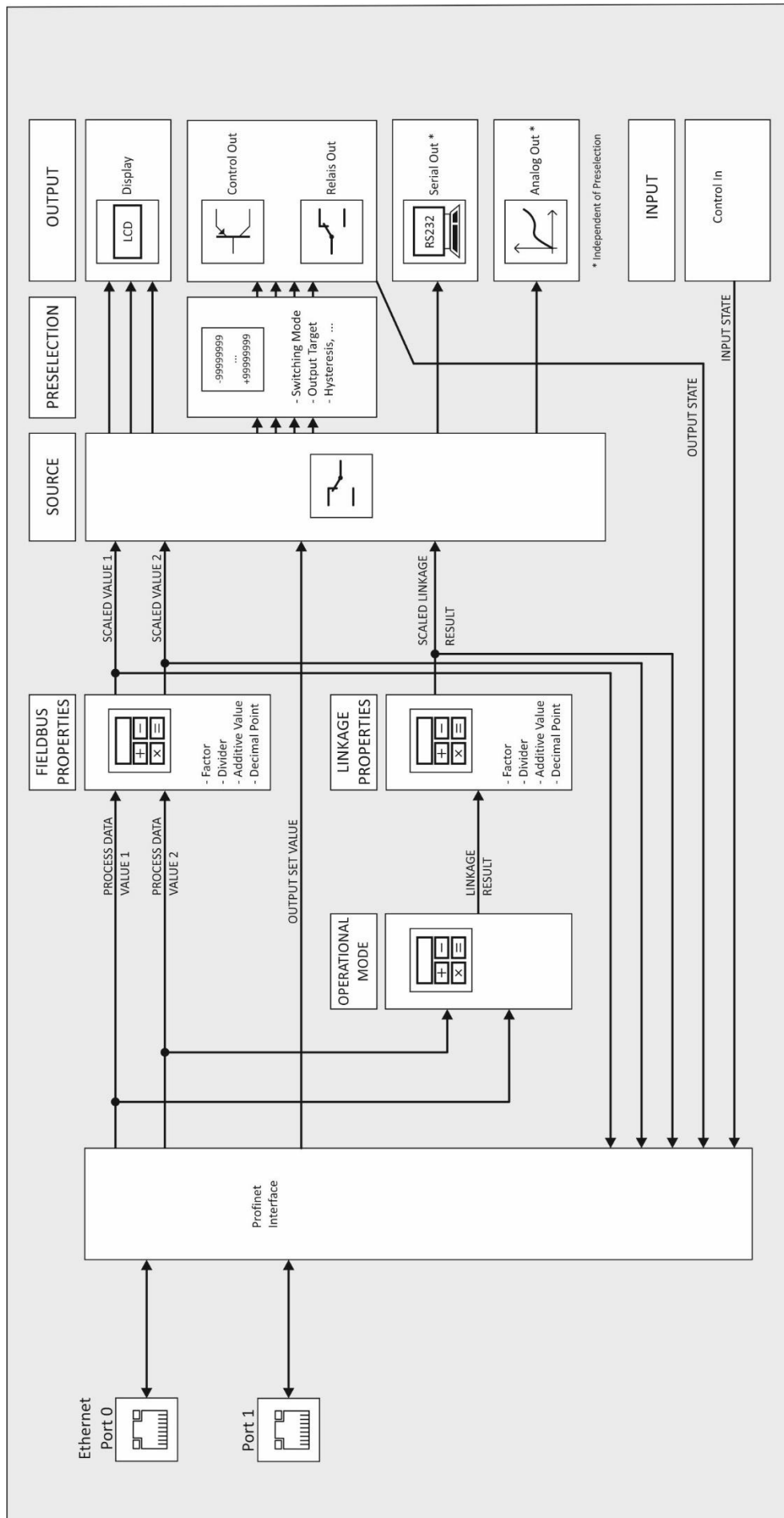

3. Electrical Connections

The terminal screws should be tightened with a slotted screwdriver (blade width 2mm).

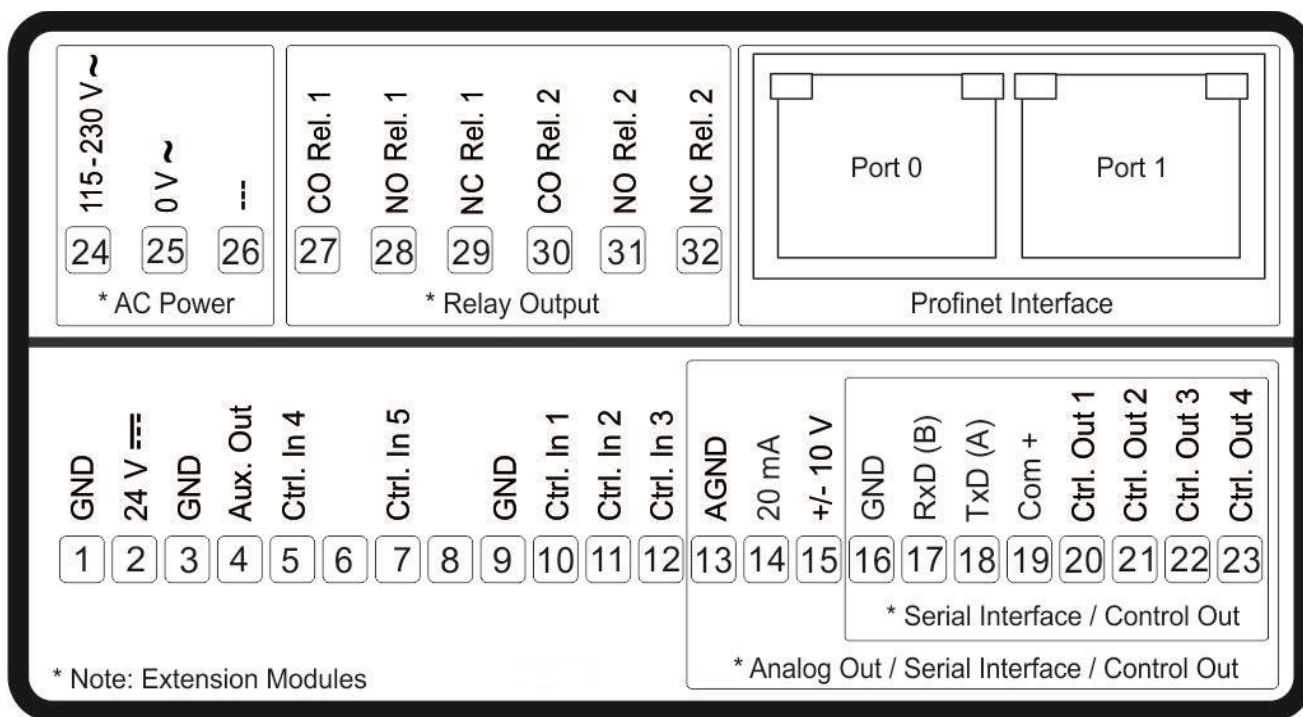

3.1. DC Power Supply

The unit accepts DC supply from 18 to 30 V at the terminals 1 and 2. The power consumption depends on the level of the supply voltage with approx. 100 mA and the additional current required at the Auxiliary Voltage Output.

All GND terminals are internally interconnected.

3.2. Auxiliary Voltage Output

Terminal 3 and 4 provide an auxiliary output for supply of sensors and encoders. The output voltage depends on the power supply.

DC version	AC version
The encoder voltage is approx. 1 V lower than the power supply voltage at terminal 1 and 2 and should be loaded with max. 250 mA	The encoder voltage is 24 VDC ($\pm 15\%$) and should be loaded with max. 150 mA up to 45 degrees Celsius. At higher temperature the maximum output current is reduced to 80 mA.

3.3. PROFINET Interface

The PROFINET interface provides 2 RJ45 Ethernet connectors (Port 0 and 1) with an integrated switch for full duplex communication up to 100 Mbit/s.

3.3.1. LEDs

Both ports have a yellow and a green status LED:

Green ("LINK") is on when an Ethernet connection has been established via the port.

Yellow ("ACTIVITY") flickers when data is being sent or received through the port.

Two red PROFINET status LEDs are located on the left side of the device behind the ventilation slots:

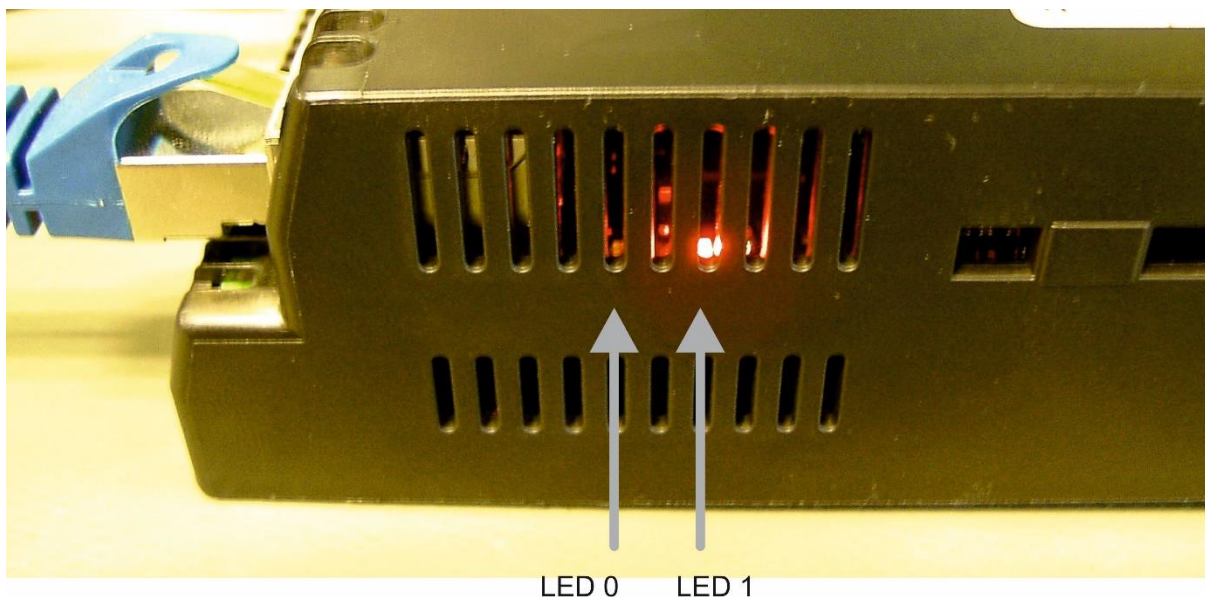

- | | | |
|--------|-----------|--|
| LED 0: | off: | Normal operation |
| | flashing: | Device identification by PROFINET service "DCP Signal" |
| | on: | Alarm pending (see error message on display) |
| LED 1: | off: | PROFINET communication running |
| | flashing: | Device has finished initialization, Ethernet link established, Profinet communication not yet running. |
| | on: | Temporarily after power on (for some seconds): Initialization
Permanently: No Ethernet connection or device faulty. |

These LEDs are not necessary for normal operation but may be helpful during commissioning.

3.3.2. PROFINET-Configuration

The PROFINET interface is described in the corresponding GSDML file "GSDML-V2.43-MOTRONA-PN350-REPNS-xxxxxxx".

The device has one single slot, to which the "PN350" module is dedicated. The module has a single subslot with a fixed submodule.

3.3.3. Process Data

With the cyclic PROFINET communication, the PROFINET IO controller sends 9 bytes of **process output data** to the PN350:

- Process Data Value 1, 4 bytes
- Process Data Value 2, 4 bytes
- Output Set Value, 1 byte

Process Data Value 1 and Process Data Value 2 can be scaled and provided with units using the parameters in the "Fieldbus Properties" menu (chapter [5.2](#)).

In addition, a so-called "Linkage value" is calculated from the two process data values. The linkage value can be scaled separately and also provided with units. The type of link (+, -, x or /) is set with the "Operational Mode" parameter in the General menu (chapter [5.1](#)), while the scaling is set by the parameters in the "Linkage Properties" menu (chapter [5.3](#)).

The three scaled values can then optionally be displayed on the display, see sections "Display during operation" (chapter [4.2](#)) and "Display menu" (chapter [5.12](#)). The digital control outputs and the analog output can also be controlled by the three scaled values.

With the Output Set Value, you can switch directly those outputs that are not assigned to any preselection switching condition (see parameter "Output Target ..." in chapter [5.5](#) ff). Bits 0...3 of Output Set Value represent the Ctrl outputs Out 1...4 while bits 4 and 5 represent the relays Rel. 1 and Rel. 2.

The PN350 sends 17 bytes of **process input data** to the PROFINET IO controller:

- The scaled display value 1, 4 byte
- The scaled display value 2, 4 byte
- The scaled linkage value, 4 byte
- The actual value of the control inputs (Digital Input value), 4 Byte:
In this status value, bits 0...4 represent the inputs Ctrl. In 1...4.
(Bits 5...31 are not used and are fixed at 0)
- The actual value of the control outputs (Digital Output Value), 1 byte:
In this status byte, bits 0...3 represent the outputs Ctrl. Out 1...4 and bits 4 and 5 the relays Rel. 1 and Rel. 2.

3.3.4. Acyclic Data Exchange

With the acyclic PROFINET communication (Record Data Services), all device parameters of the PN350 can be accessed via slot 1 / subslot 1. All parameter values are signed 32-bit values (4 bytes). The index of each individual register you can find in the parameter tables in Chapter [6.2](#).

3.4. Control Inputs

Five control inputs with HTL-PNP characteristics are available at terminals 5, 7, 10, 11 and 12
Three of these inputs (Ctrl.In 1...3) are configurable in the COMMAND MENU and can be used for externally triggered functions such as switching the display, locking the touch screen or enabling the latching of control and relay outputs.

Wiring of the control inputs:

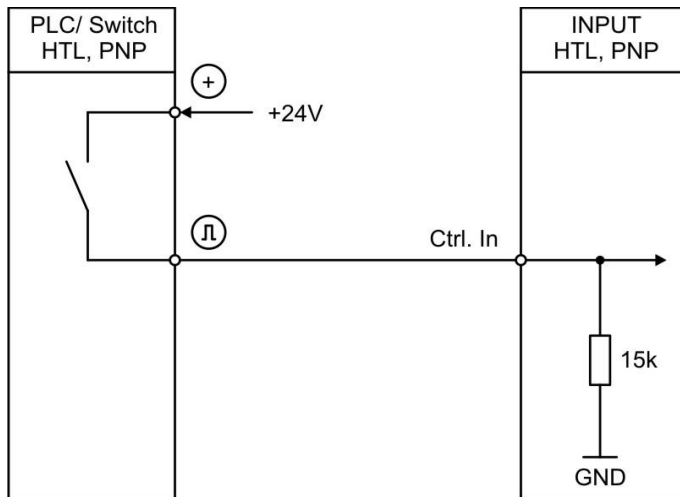

Open control inputs are always "LOW".
The input stages are designed for electronic control signals.

3.5. Analog Output (Option AO/AR)

A 16 bit analog output is available at terminal 13 and 14 / 15
This output can be configured and scaled in the ANALOG MENU.

The following configuration is possible:

- Voltage output: -10 ... +10 V
- Current output: 0 ... 20 mA
- Current output: 4 ... 20 mA

The analog output is proportional to the reference source and is referenced to potential AGND.
AGND and GND are internally interconnected.



Important:
A parallel operation with voltage and current output at the analog output is not allowed!

3.6. Serial Interface (Option AO/AR/CO/CR)

A serial interface (RS232 or RS485) is available at terminal 16, 17 und 18. This interface can be configured in the SERIAL MENU.

The serial interface RS232 or RS485 can be used:

- for easy setup and commissioning of the units
- to modify settings and parameters during operation
- to read out internal states and actual measuring values by PC or PLC

The following drawing shows the connection to a PC by using a standard Sub-D-9 connector:

Connection of the RS232 interface:

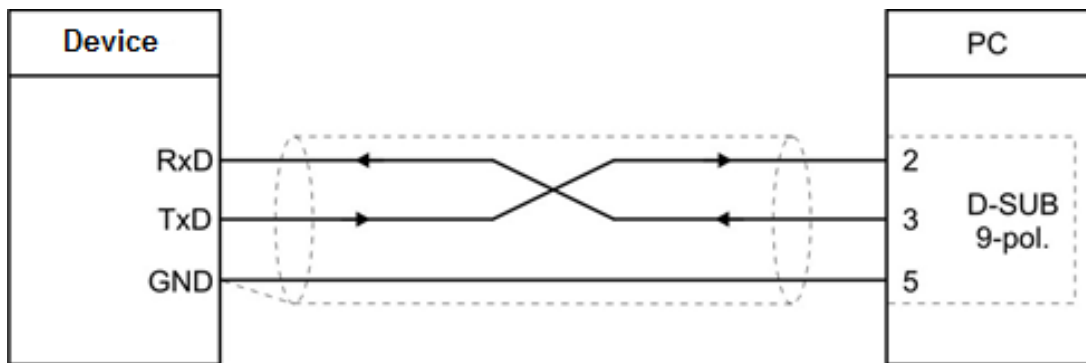

Connection of the RS485 interface:

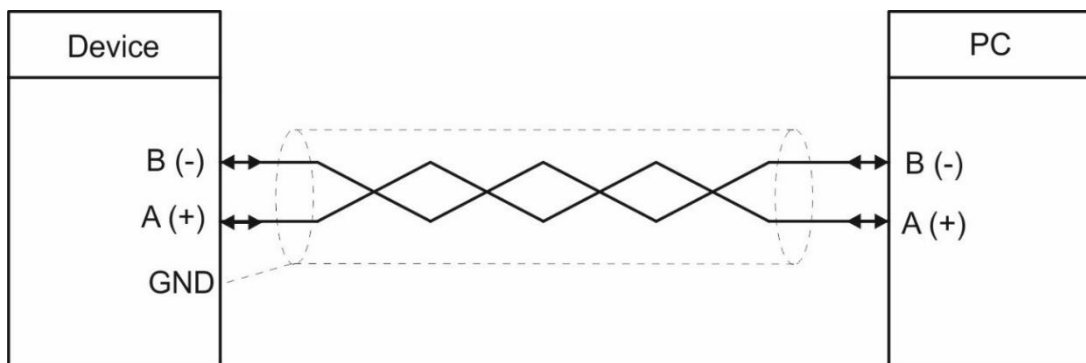

3.7. Control Outputs (Option AO/AR/CO/CR)

Four control outputs are available at terminal 20, 21, 22 and 23.

Switching conditions can be set in the PRESELECTION MENU. The output Ctrl. Out1 – 4 are fast PNP outputs with a switching capability of 5 – 30 Volt / 200 mA per channel. The switching states is displayed (display with unit and status bar) as C1 ... C4.

The switching voltage of the outputs must be applied to input terminal 19 (COM+).

In case of switching inductive loads, it is advisable to use external filtering of the coils.

Wiring of the control outputs:

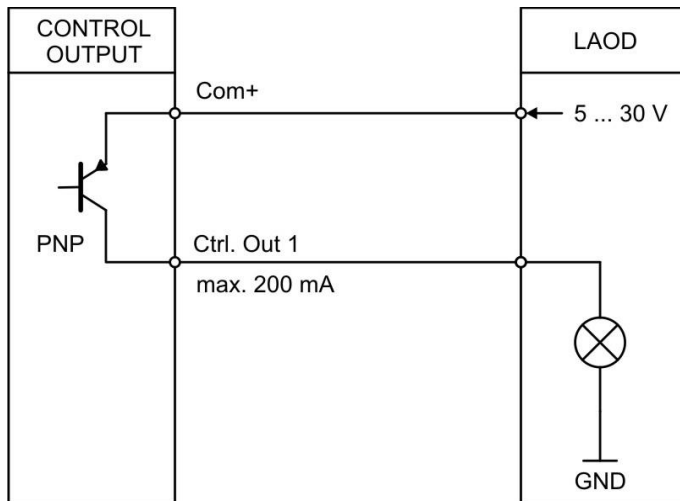

3.8. AC Power Supply (Option AC)

The unit accepts AC supply from 115 to 230 V at the terminals 24 and 25. The power consumption depends on the level of the supply voltage with approx. 3VA and the additional current required at the auxiliary voltage output.

Devices with option AC can also be supplied with a DC voltage between 18 and 30 VDC at terminals 1 and 2.

3.9. Relay Outputs (Option RL)

Two relay outputs with potential-free changeover contacts are available at terminal 27, 28, 28, 30, 31, 32. Switching conditions can be set in the PRESELECTION MENU. The switching state is displayed (display with unit and status bar) as K1 and K4.

AC-switching capacity max. 250 VAC/ max. 3 A / 750 VA

DC-switching capacity max. 150 VAC/ max. 2 A / 50 W

Wiring of the relay outputs:

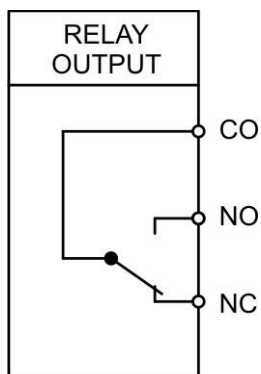

4. Display and Touch Screen

4.1. Screen Structure for Parameterization

The parameter menus and the parameters are described in chapter [5](#).

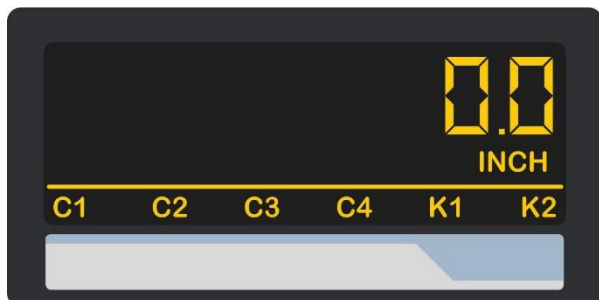

Start setup procedure:

To edit the parameters, press the touch screen for 3 seconds.



Menu selection:

Select the parameter menu via arrow buttons and confirm with "OK".

The menu selection can be terminated with „C“.



Parameter selection:

Select the parameter via arrow buttons and confirm with „OK“.

The parameter selection can be terminated with „C“.



Parameter editing:

Edit the parameter via arrow button up and down, shift cursor via left and right and save with „OK“.

The parameter editing can be terminated with „C“.



Parameter changes becomes active only after closing the menu selection.

4.2. Screen Structure in Operation

During operation, either the two process data values and/or the linked value can be displayed. The values to be displayed are selected in the display menu. The following displays are available:

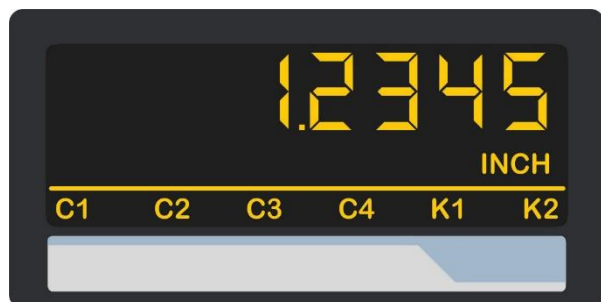

Display of a value with unit and status bar

To switch to the next display, press the touch screen.

Control or Relay status are only displayed with Option CO, CR, AO, AR or RL.

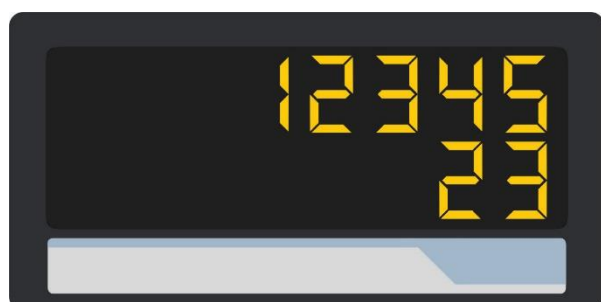

Two-line display of two values without units

To switch to the next display, press the top of the screen.

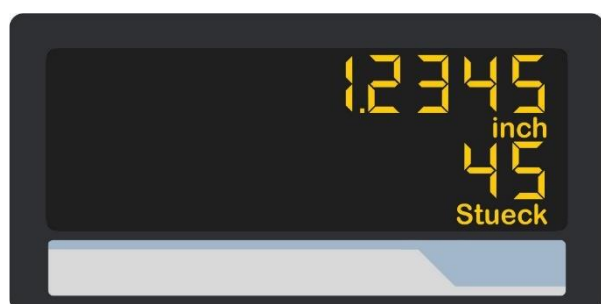

Two-line display of two values with units

To switch to the next display, press the top of the screen.



Large display (4-digits)

To switch to the next display, press the top of the screen.

This is only possible with activated parameter „LARGE DISPLAY“.



Display with command keys

To switch to the next display, press the top of the screen or "SKIP".

Continuation "Screen Structure in Operation":



Display for quick start for enter preselection values (PRESELECTION VALUES)

To switch to the next display, press the top of the screen or "SKIP".

This is only possible with option CO, CR, AO, AR or RL.



Display with minimum and maximum values

To switch to the next display, press the top of the screen or "SKIP".

If there is no valid display value because the cyclic PROFINET data exchange has not yet started, dashes ("-----") are displayed instead of the respective display value.

4.3. Error Messages

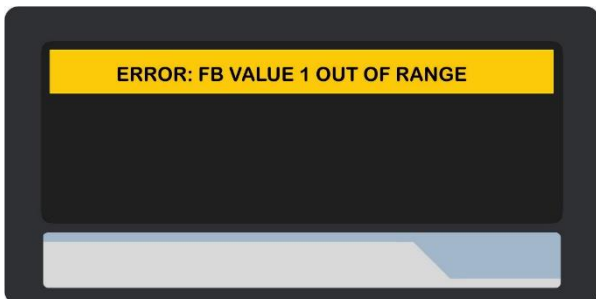

ERROR: FB VALUE 1 OUT OF RANGE

The value range of process data value 1 has been exceeded.

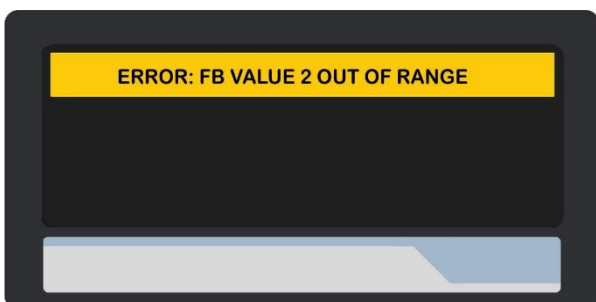

ERROR: FB VALUE 2 OUT OF RANGE

The value range of process data value 2 has been exceeded.

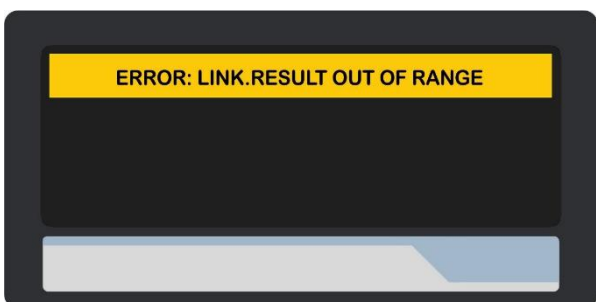

ERROR: LINK.RESULT OUT OF RANGE

The value range of the linked display value has been exceeded

Continuation "Error Messages":

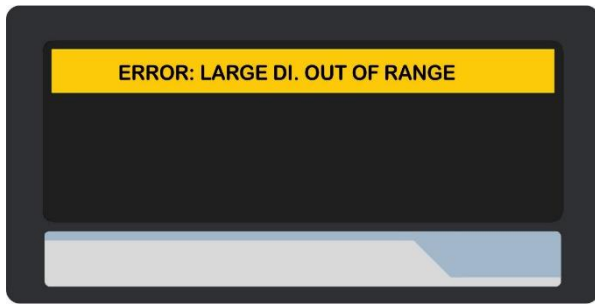

ERROR: LARGE DI. OUT OF RANGE

The value range of the large display has been exceeded

All error messages are displayed flashing.

A corresponding diagnostic alarm is sent via PROFINET for each error message



The error messages described are automatically reset as soon as the corresponding display value is back in the displayable range.

5. Parameter / Overview – Menu Structure

The parameterization of the device is realized via the serial interface with a PC and the operating software OS. The link to the free download can be found on page 2.

This section provides an overview of the menus and their parameters. The menu names are printed bold and the associated parameters are listed under the menu name.

Menu / Parameter
GENERAL MENU
OPERATIONAL MODE
ENCODER SUPPLY
PIN PRESELECTION
PIN PARAMETER
FACTORY SETTINGS
FIELDBUS PROPERTIES
IN1 FACTOR
IN1 DIVIDER
IN1 ADDITIVE VALUE
IN1 DECIMAL POINT
IN1 SCALE UNIT
IN2 FACTOR
IN2 DIVIDER
IN2 ADDITIVE VALUE
IN2 DECIMAL POINT
IN2 SCALE UNIT
(FB VALUE IN 0)*
(FB VALUE IN 1)*
(FB VALUE IN 2)*
(FB VALUE IN 3)*
(FB VALUE OUT 0)*
(FB VALUE OUT 1)*
(FB VALUE OUT 2)*
(FB VALUE OUT 3)*
LINKAGE PROPERTIES
FACTOR
DIVIDER
ADDITIVE VALUE
DECIMAL POINT
SCALE UNIT

*) Not visible in the menu

Menu / Parameter
PRESELECTION VALUES
PRESELECTION 1
PRESELECTION 2
PRESELECTION 3
PRESELECTION 4
PRESELECTION 1 MENU
SOURCE 1
MODE 1
HYSTERESIS 1
PULSE TIME 1
OUTPUT TARGET 1
OUTPUT POLARITY 1
OUTPUT LOCK 1
START UP DELAY 1
EVENT COLOR 1
PRESELECTION 2 MENU
SOURCE 2
MODE 2
HYSTERESIS 2
PULSE TIME 2
OUTPUT TARGET 2
OUTPUT POLARITY 2
OUTPUT LOCK 2
START UP DELAY 2
EVENT COLOR 2
PRESELECTION 3 MENU
SOURCE 3
MODE 3
HYSTERESIS 3
PULSE TIME 3
OUTPUT TARGET 3
OUTPUT POLARITY 3
OUTPUT LOCK 3
START UP DELAY 3
EVENT COLOR 3

Continuation "Parameter / Overview – Menu Structure"

Menu / Parameter
PRESELECTION 4 MENU
SOURCE 4
MODE 4
HYSTERESIS 4
PULSE TIME 4
OUTPUT TARGET 4
OUTPUT POLARITY 4
OUTPUT LOCK 4
START UP DELAY 4
EVENT COLOR 4
SERIAL MENU
UNIT NUMBER
SERIAL BAUD RATE
SERIAL FORMAT
SERIAL PROTOCOL
SERIAL TIMER
SERIAL VALUE
MODBUS
ANALOG MENU
ANALOG SOURCE
ANALOG FORMAT
ANALOG START
ANALOG END
ANALOG GAIN
ANALOG OFFSET
COMMAND MENU
INPUT 1 ACTION
INPUT 1 CONFIG
INPUT 2 ACTION
INPUT 2 CONFIG
INPUT 3 ACTION
INPUT 3 CONFIG

Menu / Parameter
DISPLAY MENU
START DISPLAY
SOURCE SINGLE
SOURCE DUAL TOP
SOURCE DUAL DOWN
LARGE DISPLAY
COLOR
BRIGHTNESS
CONTRAST
SCREEN SAVER
UP-DATE-TIME
FONT
QUICKSTART BUTTON

5.1. General Menu

In all parameter tables, the values with a gray background are the default values (factory settings) of the respective parameter.

OPERATIONAL MODE

This parameter defines how the linked display value is calculated.

0	VALUE1 + VALUE2	The linked value is the sum of the two process data values
1	VALUE1 – VALUE2	The linked value is the difference of the two process data values
2	VALUE1 x VALUE2	The linked value is the product of the two process data values
3	VALUE1 / VALUE2	The linked value is the quotient of the two process data values

ENCODER SUPPLY

This parameter defines the voltage of the auxiliary supply output (Aux-Out).

0	24VDC SUPPLY	24 VDC encoder supply
1	5VDC SUPPLY	5 VDC encoder supply

PIN PRESELECTION

This parameter defines the PIN-code to lock the quick start of the menu PRESELECTION VALUE for entering the preselection values. (Master PIN 6079).

This Lock function is only useful in conjunction with active lock function in PIN PARAMETER.

	0000	No lock
	...	
	9999	Access after entering PIN code 9999

PIN PARAMETER

This parameter defines the PIN code for lock function of all parameters (master PIN 6079).

	0000	No lock
	...	
	9999	Parameterization of the unit after entering PIN code 9999

FACTORY SETTINGS

0	NO	No default values are loaded
1	YES	Load default values of all parameters (grey marked default values)

5.2. Fieldbus Properties

The parameters for displaying the process data values are set in this menu.

IN1 FACTOR (Multiplication factor for process data value 1) This parameter defines the factor by which the process data value 1 is multiplied.		
	-99999999	Smallest value
	1	Default value
	99999999	Highest value

IN1 DIVIDER (Division factor for process data value 1) This parameter defines the divisor by which the process data value 1 is divided.		
	-99999999	Smallest value
	1	Default value
	99999999	Highest value

IN1 ADDITIVE VALUE (Additive constant for process data value 1) This parameter defines an additive constant that is added to the process data value 1.		
	-99999999	Smallest value
	0	Default value
	99999999	Highest value

IN1 DECIMAL POINT (Decimal point for process data value 1) This setting defines the position of the decimal point for the process data value 1.		
	0 NO	No decimal point
	1 0000000.0	Decimal point at the specified position
	2 000000.00	Decimal point at the specified position
	3 00000.000	Decimal point at the specified position
	4 0000.0000	Decimal point at the specified position
	5 000.00000	Decimal point at the specified position
	6 00.000000	Decimal point at the specified position
	7 0.0000000	Decimal point at the specified position

Continuation "Fieldbus Properties":

IN 1 SCALE UNIT (Unit of measure for process data value 1)																																																																																																		
This parameter defines which unit is shown for the process data value 1 in the display. The setting of the SCALE UNITS does not affect the displayed value.																																																																																																		
0	Hz	Default																																																																																																
1	kHz																																																																																																	
2	m/s																																																																																																	
3	m/min																																																																																																	
4	km/h																																																																																																	
5	mph																																																																																																	
6	1/min																																																																																																	
7	RPM																																																																																																	
8	1/sec																																																																																																	
9	RPS																																																																																																	
10	Stk/h																																																																																																	
11	pcs/h																																																																																																	
12	mm																																																																																																	
13	m																																																																																																	
14	inch																																																																																																	
15	feet																																																																																																	
16	Stueck																																																																																																	
17	pcs																																																																																																	
18	sec																																																																																																	
19	min																																																																																																	
20	Min:Sec																																																																																																	
21	H:M:S																																																																																																	
22	Min:Sec:00																																																																																																	
23	l/min																																																																																																	
24	gal/min																																																																																																	
25	ml/min																																																																																																	
26	gr/min																																																																																																	
27	inch/min																																																																																																	
28	H:M																																																																																																	
29	Edit Unit	<p>A customized unit with up to 16 digits can be edited using this parameter. Pressing the "OK" button opens the Edit Unit Menu.</p> <p>A unit can be created using the arrow keys. (by pressing and holding the arrow keys the characters scroll fast).</p> <p>The "OK" button saves the Edit Unit Menu. The "C" button closes the Edit Unit Menu.</p> <table border="1"> <tr> <td></td><td>!</td><td>"</td><td>#</td><td>\$</td><td>%</td><td>&</td><td>'</td><td>(</td><td>)</td><td>*</td><td>+</td><td>,</td><td>-</td><td>.</td><td>/</td> </tr> <tr> <td>0</td><td>1</td><td>2</td><td>3</td><td>4</td><td>5</td><td>6</td><td>7</td><td>8</td><td>9</td><td>:</td><td>;</td><td><</td><td>=</td><td>></td><td>?</td> </tr> <tr> <td>@</td><td>A</td><td>B</td><td>C</td><td>D</td><td>E</td><td>F</td><td>G</td><td>H</td><td>I</td><td>J</td><td>K</td><td>L</td><td>M</td><td>N</td><td>O</td> </tr> <tr> <td>P</td><td>Q</td><td>R</td><td>S</td><td>T</td><td>U</td><td>V</td><td>W</td><td>X</td><td>Y</td><td>Z</td><td>[</td><td>\</td><td>]</td><td>^</td><td>_</td> </tr> <tr> <td>`</td><td>a</td><td>b</td><td>c</td><td>d</td><td>e</td><td>f</td><td>g</td><td>h</td><td>i</td><td>j</td><td>k</td><td>l</td><td>m</td><td>n</td><td>o</td> </tr> <tr> <td>p</td><td>q</td><td>r</td><td>s</td><td>t</td><td>u</td><td>v</td><td>w</td><td>x</td><td>y</td><td>z</td><td>{</td><td> </td><td>}</td><td>~</td><td></td> </tr> </table>		!	"	#	\$	%	&	'	()	*	+	,	-	.	/	0	1	2	3	4	5	6	7	8	9	:	;	<	=	>	?	@	A	B	C	D	E	F	G	H	I	J	K	L	M	N	O	P	Q	R	S	T	U	V	W	X	Y	Z	[\]	^	_	`	a	b	c	d	e	f	g	h	i	j	k	l	m	n	o	p	q	r	s	t	u	v	w	x	y	z	{		}	~	
	!	"	#	\$	%	&	'	()	*	+	,	-	.	/																																																																																			
0	1	2	3	4	5	6	7	8	9	:	;	<	=	>	?																																																																																			
@	A	B	C	D	E	F	G	H	I	J	K	L	M	N	O																																																																																			
P	Q	R	S	T	U	V	W	X	Y	Z	[\]	^	_																																																																																			
`	a	b	c	d	e	f	g	h	i	j	k	l	m	n	o																																																																																			
p	q	r	s	t	u	v	w	x	y	z	{		}	~																																																																																				

Continuation "Fieldbus Properties":

IN2 FACTOR (Multiplication factor for process data value 2) This parameter defines the factor by which the process data value 2 is multiplied.		
	-99999999	Smallest value
	1	Default value
	99999999	Highest value

IN2 DIVIDER (Division factor for process data value 2) This parameter defines the divisor by which the process data value 2 is divided.		
	-99999999	Smallest value
	1	Default value
	99999999	Highest value

IN2 ADDITIVE VALUE (Additive constant for process data value 2) This parameter defines an additive constant that is added to the process data value 2.		
	-99999999	Smallest value
	0	Default value
	99999999	Highest value

IN2 DECIMAL POINT (Decimal point for process data value 2) This setting defines the position of the decimal point for the process data value 2.		
	0 NO	No decimal point
	1 0000000.0	Decimal point at the specified position
	2 000000.00	Decimal point at the specified position
	3 00000.000	Decimal point at the specified position
	4 0000.0000	Decimal point at the specified position
	5 000.00000	Decimal point at the specified position
	6 00.000000	Decimal point at the specified position
	7 0.0000000	Decimal point at the specified position

IN 2 SCALE UNIT (Unit of measure for process data value 2) This parameter defines which unit is shown for the process data value 2 in the display. The setting of the SCALE UNITS does not affect the displayed value.		
Settings see parameter IN 1 SCALE UNIT		

FB VALUE IN 0 * Reserved for future use, must remain set to the default value.		
	00	Smallest value
	00	Default value
	00	Highest value

Continuation "Fieldbus Properties":

FB VALUE IN 1 *		
Reserved for future use, must remain set to the default value.		
	01	Smallest value
	01	Default value
	01	Highest value

FB VALUE IN 2 *		
Reserved for future use, must remain set to the default value.		
	02	Smallest value
	02	Default value
	02	Highest value

FB VALUE IN 3 *		
Reserved for future use, must remain set to the default value.		
	27	Smallest value
	27	Default value
	27	Highest value

FB VALUE OUT 0 *		
Reserved for future use, must remain set to the default value.		
	00	Smallest value
	00	Default value
	00	Highest value

FB VALUE OUT 1 *		
Reserved for future use, must remain set to the default value.		
	01	Smallest value
	01	Default value
	01	Highest value

FB VALUE OUT 2 *		
Reserved for future use, must remain set to the default value.		
	02	Smallest value
	02	Default value
	02	Highest value

FB VALUE OUT 3 *		
Reserved for future use, must remain set to the default value.		
	03	Smallest value
	03	Default value
	03	Highest value

*) Not visible in the menu

5.3. Linkage Properties

The parameters for displaying the linked display value are set in this menu

FACTOR (Multiplication factor) This parameter defines the factor by which the result of the link is multiplied.		
	-99999999	Smallest value
	1	Default value
	99999999	Highest value

DIVIDER (Division factor) This parameter defines the divisor by which the result of the link is divided.		
	-99999999	Smallest value
	1	Default value
	99999999	Highest value

ADDITIVE VALUE (Additive value) This parameter defines an additive constant that is added to the result of the link.		
	-99999999	Smallest value
	0	Default value
	99999999	Highest value

DECIMAL POINT (Decimal point) This setting defines the position of the decimal point for the link.		
	0 NO	No decimal point
	1 0000000.0	Decimal point at the specified position
	2 000000.00	Decimal point at the specified position
	3 00000.000	Decimal point at the specified position
	4 0000.0000	Decimal point at the specified position
	5 000.00000	Decimal point at the specified position
	6 00.000000	Decimal point at the specified position
	7 0.0000000	Decimal point at the specified position

SCALE UNITS (Unit of measurement display) This parameter defines which unit is shown for the linked value in the display. A setting of the SCALE UNITS does not affect the displayed value.		
Settings see parameter IN 1 SCALE UNIT		

5.4. Preselection Values

This menu is used to set the preselection values or the switching points.

The preselection values are always referred to the selected SOURCE of the PRESELECTION MENU.

This menu is only available for devices with option CO, CR, AO, AR or RL.

PRESELECTION 1		
Preselection / switching point 1		
	-99999999	Smallest preselection value
	1000	Default value
	+99999999	Highest preselection value

PRESELECTION 2		
Preselection / switching point 2		
	-99999999	Smallest preselection value
	2000	Default value
	+99999999	Highest preselection value

PRESELECTION 3		
Preselection / switching point 3		
	-99999999	Smallest preselection value
	3000	Default value
	+99999999	Highest preselection value

PRESELECTION 4		
Preselection / switching point 4		
	-99999999	Smallest preselection value
	4000	Default value
	+99999999	Highest preselection value

5.5. Preselection 1 Menu

In this menu, the parameters of the reference source, the switching conditions and further definitions for preset value / switching point 1 are defined.

This function is only available for devices with option CO, CR, AO, AR or RL.

SOURCE 1		
This parameter defines the reference source for preselection 1		
0	FIELD BUS VALUE 1	Reference source is the process data value 1
1	FIELD BUS VALUE 2	Reference source is the process data value 2
2	LINKAGE RESULT	Reference source is the linked display value

MODE 1		
Switching condition for preselection 1. Output/ relay switches under the following conditions:		
0	$ \text{RESULT} \geq \text{PRES} $	<p>Absolute value of the display value is greater or equal absolute value of PRESELECTION 1</p> <p>With HYSTERESIS 1 not equal 0 the following switching condition is applied: $\text{Display value} \geq \text{PRESELECTION 1} \rightarrow \text{ON}$, $\text{Display value} < \text{PRESELECTION 1} - \text{HYSTERESIS 1} \rightarrow \text{OFF}$</p>
1	$ \text{RESULT} \leq \text{PRES} $	<p>Absolute value of the display value is less or equal absolute value of PRESELECTION 1</p> <p>With HYSTERESIS 1 not equal 0 the following switching condition is applied: $\text{Display value} \leq \text{PRESELECTION 1} \rightarrow \text{ON}$, $\text{Display value} > \text{PRESELECTION 1} + \text{HYSTERESIS 1} \rightarrow \text{OFF}$</p>
2	$ \text{RESULT} = \text{PRES} $	<p>Absolute value of the display value is equal absolute value of PRESELECTION 1. A range (Preselection +/- 1/2 Hysteresis) can be defined and monitored in conjunction with HYSTERESIS 1</p> <p>With HYSTERESIS 1 not equal 0 the following switching condition is applied: $\text{Display value} > \text{PRESELECTION 1} + \frac{1}{2} \text{HYSTERESIS 1} \rightarrow \text{OFF}$, $\text{Display value} < \text{PRESELECTION 1} - \frac{1}{2} \text{HYSTERESIS 1} \rightarrow \text{OFF}$</p>
3	$\text{RESULT} \geq \text{PRES}$	<p>Display value is greater or equal PRESELECTION 1</p> <p>With HYSTERESIS 1 not equal 0 the following switching condition is applied: $\text{Display value} \geq \text{PRESELECTION 1} \rightarrow \text{ON}$, $\text{Display value} < \text{PRESELECTION 1} - \text{HYSTERESIS 1} \rightarrow \text{OFF}$</p>
4	$\text{RESULT} \leq \text{PRES}$	<p>Display value is less or equal PRESELECTION 1</p> <p>With HYSTERESIS 1 not equal 0 the following switching condition is applied: $\text{Display value} \leq \text{PRESELECTION 1} \rightarrow \text{ON}$, $\text{Display value} > \text{PRESELECTION 1} + \text{HYSTERESIS 1} \rightarrow \text{OFF}$</p>
5	$\text{RESULT} = \text{PRES}$	<p>Display value is equal PRESELECTION 1. A range (Preselection +/- 1/2 Hysteresis) can be defined and monitored in conjunction with HYSTERESIS 1.</p> <p>With HYSTERESIS 1 not equal 0 the following switching condition is applied: $\text{Display value} > \text{PRESELECTION 1} + \frac{1}{2} \text{HYSTERESIS 1} \rightarrow \text{OFF}$, $\text{Display value} < \text{PRESELECTION 1} - \frac{1}{2} \text{HYSTERESIS 1} \rightarrow \text{OFF}$</p>
6	$\text{RES} \geq \text{PRES-TRAIL}$	<p>Trailing PRESELECTION 1: Display value is greater or equal PRESELECTION 2 – PRESELECTION 1 PRESELECTION 1 is the trailing value from PRESELECTION 2</p>
7	ERROR SET	Error message for device errors

Continuation "Preselection 1 Menu":

HYSTERESIS 1		
This parameter defines the switching hysteresis of the switch-off point for preselection 1		
	0	No switching hysteresis
	...	
	9999	Switching hysteresis of 99999

PULSE TIME 1 (S)		
Duration of output pulse for the switching condition of preselection 1.		
	0.000	No output pulse (static signal)
	...	
	60.000	Pulse duration of 60 seconds

OUTPUT TARGET 1			
Assignment of an output or relay for the switching condition of preselection 1.			
If more than one switching condition is assigned to one output / relay, the output is set when at least one switching condition is true.			
If an output is not assigned a switching condition in any of the Output Target 1...4 parameters, the output can be controlled directly via PROFINET with the process output data byte "Output Set Value".			
	0	NO	No assignment
	1	CTRL OUT 1	Switching condition assigned to "Ctrl. Out 1"
	2	CTRL OUT 2	Switching condition assigned to "Ctrl. Out 2"
	3	CTRL OUT 3	Switching condition assigned to "Ctrl. Out 3"
	4	CTRL OUT 4	Switching condition assigned to "Ctrl. Out 4"
	5	RELAY 1	Switching condition assigned to "Rel. 1"
	6	RELAY 2	Switching condition assigned to "Rel. 2"

OUTPUT POLARITY 1			
Polarity for the switching condition of preselection 1.			
	0	ACTIVE HIGH	Switching condition is true → Output is „HIGH“
	1	ACTIVE LOW	Switching condition is true → Output is „LOW“

OUTPUT LOCK 1			
Latch for the switching condition of preselection 1			
	0	NO	No latch for preselection
	1	YES	Latch for preselection (command LOCK RELEASE will clear latch)

Continuation "Preselection 1 Menu":

EVENT COLOR 1		
Event-depending change of the display color for the switching condition of preselection 1. EVENT COLOR 1 has the lowest priority. EVENT COLOR 2 ... 4 are allowed to overwrite this color change.		
0	NO CHANGE	No color change
1	CHANGE TO RED	Color change to red
2	CHANGE TO GREEN	Color change to green
3	CHANGE TO YELLOW	Color change to yellow

5.6. Preselection 2 Menu

SOURCE 2		
The reference source for preselection 2, see PRESELECTION 1 MENU.		

MODE 2		
Switching conditions for preselection 2, see PRESELECTION 1 MENU (except trailing preselection).		
		See PRESELECTION 1 MENU
6	RES>=PRES-TRAIL	Trailing preselection 2: Display value is greater or equal to PRESELECTION 1 – PRESELECTION 2 PRESELECTION 2 is the trailing preselection of PRESELECTION 1.

HYSTERESIS 2		
This parameter defines the switching hysteresis of the switch-off point for preselection 2. See PRESELECTION 1 MENU.		

PULSE TIME 2 (S)		
Duration of output pulse for the switching condition of preselection 2. See PRESELECTION 1 MENU.		

OUTPUT TARGET 2		
Assignment of an output or relay for the switching condition of preselection 2. See PRESELECTION 1 MENU.		

OUTPUT POLARITY 2		
Polarity for the switching condition of preselection 2. See PRESELECTION 1 MENU.		

OUTPUT LOCK 2		
Latch for the switching condition of preselection 2. See PRESELECTION 1 MENU.		

EVENT COLOR 2		
Event-depending change of the display color for the switching condition of preselection 2. See PRESELECTION 1 MENU.		

5.7. Preselection 3 Menu

SOURCE 3

The reference source for preselection 3, see PRESELECTION 1 MENU.

MODE 3

Switching conditions for preselection 3, see PRESELECTION 1 MENU (except trailing preselection)

			see PRESELECTION 1 MENU
6	RES>=PRES-TRAIL		Trailing preselection 3: Display value is greater or equal to PRESELECTION 4 – PRESELECTION 3 PRESELECTION 3 is the trailing preselection of PRESELECTION 4.

HYSTERESIS 3

This parameter defines the switching hysteresis of the switch-off point for preselection 3.
See PRESELECTION 1 MENU.

PULSE TIME 3 (S)

Duration of output pulse for the switching condition of preselection 3.
See PRESELECTION 1 MENU.

OUTPUT TARGET 3

Assignment of an output or relay for the switching condition of preselection 3.
See PRESELECTION 1 MENU.

OUTPUT POLARITY 3

Polarity for the switching condition of preselection 3.
See PRESELECTION 1 MENU.

OUTPUT LOCK 3

Latch for the switching condition of preselection 3.
See PRESELECTION 1 MENU.

EVENT COLOR 3

Event-depending change of the display color for the switching condition of preselection 3.
See PRESELECTION 1 MENU.

5.8. Preselection 4 Menu

SOURCE 4

The reference source for preselection 4, see PRESELECTION 1 MENU.

MODE 4

Switching conditions for preselection 4, see PRESELECTION 1 MENU (except trailing preselection)

			see PRESELECTION 1 MENU.
9	RES \geq PRES-TRAIL		Trailing preselection 4: Display value is greater or equal to PRESELECTION 3 – PRESELECTION4 PRESELECTION 4 is the trailing preselection of PRESELECTION 3.

HYSTERESIS 4

This parameter defines the switching hysteresis of the switch-off point for preselection 4.

See PRESELECTION 1 MENU

PULSE TIME 4 (S)

Duration of output pulse for the switching condition of preselection 4.

See PRESELECTION 1 MENU.

OUTPUT TARGET 4

Assignment of an output or relay for the switching condition of preselection 4.

See PRESELECTION 1 MENU.

OUTPUT POLARITY 4

Polarity for the switching condition of preselection 4.

See PRESELECTION 1 MENU.

OUTPUT LOCK 4

Latch for the switching condition of preselection 4.

See PRESELECTION 1 MENU.

EVENT COLOR 4

Event-depending change of the display color for the switching condition of preselection 4.

See PRESELECTION 1 MENU.

5.9. Serial Menu

This menu defines the basic settings of serial interface.

This function is only available for devices with option CO, CR, AO or AR

UNIT NUMBER

This parameter defines the serial device address. The addresses between 11 and 99 can be assigned to the device. Addresses with zero are not allowed, because these are used as broadcast addresses.

	11	Smallest address without zero
	...	
	99	Highest address without zero

SERIAL BAUD RATE

This parameter defines the serial baud rate.

	0	9600	9600 baud
	1	19200	19200 baud
	2	38400	38400 baud
	3	115200	115200 baud

SERIAL FORMAT

This parameter defines the bit data format.

	0	8-EVEN-1	8 data	Parity even	1 Stopp
	1	8-ODD-1	8 data	Parity odd	1 Stopp
	2	8-NONE-1	8 data	no Parity	1 Stopp
	3	8-NONE-2	8 data	no Parity	2 Stopps

SERIAL PROTOCOL

Determines the sequence of characters send, when using the serial output for cyclic data transmission under time control (xxxxxxx = value SERIAL VALUE).

Setting „1“ removes the unit address from the string which allows a slight faster transmission cycle.

	0	Transmission report = unit no., +/-, data, LF, CR <table border="1" style="margin-left: 20px;"> <tr> <td>1</td><td>1</td><td>+/-</td><td>X</td><td>X</td><td>X</td><td>X</td><td>X</td><td>X</td><td>X</td><td>LF</td><td>CR</td> </tr> </table>	1	1	+/-	X	X	X	X	X	X	X	LF	CR
1	1	+/-	X	X	X	X	X	X	X	LF	CR			
	1	Transmission report = +/-, data, LF, CR <table border="1" style="margin-left: 20px;"> <tr> <td>+/-</td><td>X</td><td>X</td><td>X</td><td>X</td><td>X</td><td>X</td><td>X</td><td>LF</td><td>CR</td> </tr> </table>	+/-	X	X	X	X	X	X	X	LF	CR		
+/-	X	X	X	X	X	X	X	LF	CR					

Continuation "Serial Menu":

SERIAL TIMER (S)		
This register determines the cycle time in seconds for cycling transmission of SERIAL VALUE when using the serial output. (On a serial request, the cycling transmission is stopped for 20 s)		
	0.000	All cyclic transmission is switched off. The unit will send data upon a serial request or with command SERIAL PRINT.
	...	
	60.000	Cycle time in seconds.

SERIAL VALUE			
This parameter defines the value to be transmitted.			
	Setting	Code	Register
	0	:0	Scaled Result Fieldbus Value 1
	1	:1	Scaled Result Fieldbus Value 2
	2	:2	Scaled Result Linkage Result
	3	:3	Fieldbus Value 1
	4	:4	Fieldbus Value 2
	5	:5	
	6	:6	
	7	:7	
	8	:8	Minimum Value
	9	:9	Maximum Value

MODBUS		
This parameter enables the Modbus protocol and determines the Modbus address. (For details of the Modbus communication please refer to the additional manual Modbus_RTU)		
	0	Modbus disabled: Serial interface is using Lecom protocol (Motrona default protocol)
	1 ... 247	Modbus enabled: Serial interface is using Modbus RTU protocol The set value is the Modbus address of the device.

5.10. Analog Menu

This menu defines the basic settings of the analog output.

This function is only available for devices with option AO or AR.

ANALOG SOURCE

This parameter defines the reference source for analog output.

0	FIELD BUS VALUE 1	Reference source is the process data value 1
1	FIELD BUS VALUE 2	Reference source is the process data value 2
2	LINKAGE RESULT	Reference source is the linked display value

ANALOG FORMAT

This parameter defines the output characteristics. The analogue output is proportional to the display value.

With setting ANALOG FORMAT (-10 ... +10 V) in MODE COUNTER the polarity of the analog output depends on the polarity of the display value.

0	-10...10V	-10 ... +10 V
1	0...20MA	0 ... 20 mA
2	4...20MA	4 ... 20 mA

ANALOG START

This parameter defines the start value of the analog conversion. This start value is corresponding to the display value for an analog output of 0 V or 0/4 mA.

-99999999	Smallest start value
0	Default value
+99999999	Highest start value

ANALOG END

This parameter defines the end value of the analog conversion. This end value is corresponding to the display value for an analog output of (+/-) 10 V or 20mA.

-99999999	Smallest end value
10000	Default Wert
+99999999	Highest end value

ANALOG GAIN (%)

This parameter specifies the maximum conversion of the analog output in %.

e. g. 102,00 corresponds to a conversion of 10,2 V or 20,4 mA, when the ANALOG END value is reached.

e. g. 95,00 corresponds to a conversion of 9,5 V or 18 mA, when the ANALOG END value is reached.

0.00	Smallest gain
100.00	Default value
110.00	Highest gain

ANALOG OFFSET (%)

This parameter defines the zero offset of the analog output.

e.g. 0.20 result in an offset of 0.02 V or 0.04 mA at ANALOG START value

-99.99	Smallest offset
0	Default value
+99.00	Highest offset

5.11. Command Menu

INPUT 1 ACTION (function Input 1)			
This parameter defines the function of the input "Ctrl. In 1".			
0	NO	No function	
1	FREEZE	Freeze actual display value	(s)
2	KEY LOCK	Disable touch screen	(s)
3	LOCK RELEASE	Release latching of all outputs/relays	(d)
4	RESET MIN/MAX	Reset of the min. / max. values	(d) (s)
5	SERIAL PRINT	Sending of serial data, see parameter SERIAL VALUE	(d)
6	TEACH PRESEL. 1	Current display value is stored as PRESELECTION 1	(d)
7	TEACH PRESEL. 2	Current display value is stored as PRESELECTION 2	(d)
8	TEACH PRESEL. 3	Current display value is stored as PRESELECTION 3	(d)
9	TEACH PRESEL. 4	Current display value is stored as PRESELECTION 4	(d)
10	SCROLL DISPLAY	Display switching (see display in operation mode)	(d)
11	CLEAR LOOP TIME	Release all latched switching conditions	
12	(Command 11)	N.A.	
13	START PRESELECT	N.A.	
14	ACTIVATE	N.A.	
15	STORE DATA	N.A.	
16	TESTPROGRAM	N.A.	
17	SET RED COLOR	The display lights up red. The color can be changed by the event-dependent color switching in the PRESELECTION 1... 4	(d)
18	SET GREEN COLOR	The display lights up green. The color can be changed by the event-dependent color switching in the PRESELECTION 1... 4	(d)
19	SET YELLOW COLOR	The display lights up yellow. The color can be changed by the event-dependent color switching in the PRESELECTION 1... 4	(d)
20	INC. BRIGHTNESS	Display brightness is increased	(d) (s)
21	DEC. BRIGHTNESS	Display brightness is reduced	(d) (s)

(s) = static switching (level evaluation)
 INPUT CONFIG must be set to active LOW / HIGH

(d) = dynamic switching (edge evaluation)
 INPUT CONFIG must be set to RISING/FALLING EDGE

Continuation "Command Menu":

INPUT 1 CONFIG

This parameter defines the switching characteristics of the input "Ctrl. In 1".

0	ACTIVE LOW	Active at „LOW“ (static)
1	ACTIVE HIGH	Active at „HIGH“ (static)
2	RISING EDGE	Activate at rising edge
3	FALLING EDGE	Activate at falling edge

INPUT 2 ACTION

This parameter defines the function of the input "Ctrl. In 2".
See parameter INPUT 1 ACTION.

INPUT 2 CONFIG

This parameter defines the switching characteristics of the input "Ctrl. In 2".
See parameter INPUT 1 CONFIG.

INPUT 3 ACTION

This parameter defines the function of the input "Ctrl. In 3".
See parameter INPUT 1 ACTION.

INPUT 3 CONFIG

This parameter defines the switching characteristics of the input "Ctrl. In 3".
See parameter INPUT 1 CONFIG.

5.12. Display Menu

Parameter changes become active only after closing the menu selection.

START DISPLAY		
This parameter defines the start display after switching on device.		
0	STANDARD	Display of a value with unit and status bar
1	LARGE	Large display (only the parameter „LARGE DISPLAY“ is active)
2	DOUBLE	Two-line display without units
3	DOUBLE WITH UNIT	Two-line display with units
4	COMMAND	Display with command keys
5	QUICKSTART	Display with quick start function to enter / display preselection values (only for option CO/CR/AO/AR/RL)
6	MINIMUM/MAXIMUM	Display with minimum and maximum value

SOURCE SINGLE		
Reference source of supply for single-line display <u>and</u> large display		
0	FIELD BUS VALUE 1	The process data value 1 is shown in the one-line display
1	FIELD BUS VALUE 2	The process data value 2 is shown in the one-line display
2	LINKAGE RESULT	The linked display value is shown in the single-line display

SOURCE DUAL TOP		
Reference source for two-line display, first line		
0	FIELD BUS VALUE 1	The process data value 1 is displayed in the upper line
1	FIELD BUS VALUE 2	The process data value 2 is displayed in the upper line
2	LINKAGE RESULT	The linked display value is shown in the upper line

SOURCE DUAL DOWN		
Reference source for two-line display, bottom line		
0	FIELD BUS VALUE 1	The process data value 1 is displayed in the bottom line
1	FIELD BUS VALUE 2	The process data value 2 is displayed in the bottom line
2	LINKAGE RESULT	The linked display value is shown in the bottom line

LARGE DISPLAY		
This parameter defines to switch on / off the large display.		
By splitting ratio the display value for the large display can be divided.		
(The reference source for the large display is the process value set in the "SOURCE SINGLE" parameter.)		
0	NO	Large display off
1	1:1	Large display with splitting ratio 1:1
2	1:10	Large display with splitting ratio 1:10
3	1:100	Large display with splitting ratio 1:100
4	1:1000	Large display with splitting ratio 1:1000
5	1:10000	Large display with splitting ratio 1:10000

Continuation "Display Menu":

COLOR		
This parameter defines the display color. Event-depending change of the display color by a switching condition is possible (see PRESELECTION 1...4 MENU). Event-depending changes are only available for devices with option CO, AO or RL.		
	0	RED
	1	GREEN
	2	YELLOW

BRIGHTNESS (%)		
This parameter defines the brightness of the display in percent.		
	10	Min. brightness
	90	Default value
	100	Max. brightness

CONTRAST		
This parameter defines the viewing angle.		
	0	Viewing angle from top
	1	Viewing angle from center
	2	Viewing angle from bottom

SCREEN SAVER (S)		
This parameter defines the time in seconds until the display is switched off, after the last touch action. A new touch action will activate the display again		
	0	No switch off
	...	
	9999	Longest time to switch off

UP-DATE-TIME (S)		
This parameter defines the update time of the display in seconds.		
	0.005	Shortest update time
	0.1	Default value
	9.999	Longest update time

FONT		
This parameter defines the setting of the font style.		
	0	Standard
	1	Font 1

Continuation "Display Menu":

QUICKSTART BUTTON		
This parameter determines which command key should be displayed when the display contains "QUICKSTART function" (parameter only visible with option CO/CR/AO/AR/RL).		
0	EDIT PRESEL.	Edit menu is opened after pressing the left command key and "Preselection Values" can be changed. Attention: monitoring of the switching outputs, correction of the analog output, etc. are <u>deactivated</u> as long as the editing menu is open!
1	SHOW PRESEL.	Set "Preselection Values" are displayed on the screen after pressing the left command button. The editing menu is <u>not</u> opened. The monitoring of the switching outputs, the correction of the analog output, etc. are still activated.

6. Appendix

6.1. Data Readout via Serial Interface

The free operator software OS is available at: <https://www.motrona.com/en/support/software.html>

All codes shown in the parameter SERIAL VALUE are available for serial readout by PC or PLC. The communication of Motrona devices is based on the Drivecom protocol according to ISO 1745 or the Modbus RTU protocol.

All protocol details can be found in our manual SERPRO (Drivecom) and Modbus_RTU_oi_e (Modbus RTU) for motrona devives which you can find on our homepage www.motrona.com.

To request for a data transmission you must send the following request string to the converter:

EOT	AD1	AD2	C1	C2	ENQ
-----	-----	-----	----	----	-----

EOT = control character (Hex 04)

AD1 = unit address, High Byte

AD2 = unit address, Low Byte

C1 = register code, High Byte

C2 = register code, Low Byte

ENQ = control character (Hex 05)

The following example shows the request string for readout of the actual input frequency of a monitor (Code=1) from a unit with unit address 11:

ASCII-Code:	EOT	1	1	:	1	ENQ
Hex-Code:	04	31	31	3A	31	05
Binary-Code:	0000 0100	0011 0001	0011 0001	0011 1010	0011 0001	0000 0101

After a correct request, the unit will respond:

STX	C1	C2	xxxxx	ETX	BCC
-----	----	----	-------	-----	-----

STX = control character (Hex 02)

C1 = register code, High Byte

C2 = register code, Low Byte

xxxxx = readout data

ETX = control character (Hex 03)

BCC = block check character

6.2. Parameter/ Indices and Serial Codes

#	Menu	Name	Index (hex)	Serial Code	Min	Max	Default
0	GENERAL MENU	OPERATIONAL MODE	0001	00	0	3	0
1	GENERAL MENU	ENCODER SUPPLY	0002	01	0	1	1
2	GENERAL MENU	PIN PRESELECTION	0003	02	0	9999	0
3	GENERAL MENU	PIN PARAMETER	0004	03	0	9999	0
4	GENERAL MENU	FACTORY SETTINGS	0005	04	0	1	0
5	GENERAL MENU	–	0006	05	0	0	0
6	GENERAL MENU	–	0007	06	0	0	0
7	GENERAL MENU	–	0008	07	0	0	0
8	GENERAL MENU	–	0009	08	0	0	0
9	FIELDDBUS PROPERTIES	IN1 FACTOR	000B	09	-99999999	99999999	1
10	FIELDDBUS PROPERTIES	IN1 DIVIDER	000C	10	1	99999999	1
11	FIELDDBUS PROPERTIES	IN1 ADDITIVE VALUE	000D	11	-99999999	99999999	0
12	FIELDDBUS PROPERTIES	IN1 DECIMAL POINT	000E	12	0	7	0
13	FIELDDBUS PROPERTIES	IN1 SCALE UNIT	000F	13	0	29	0
14	FIELDDBUS PROPERTIES	IN2 FACTOR	0010	14	-99999999	99999999	1
15	FIELDDBUS PROPERTIES	IN2 DIVIDER	0011	15	1	99999999	1
16	FIELDDBUS PROPERTIES	IN2 ADDITIVE VALUE	0012	16	-99999999	99999999	0
17	FIELDDBUS PROPERTIES	IN2 DECIMAL POINT	0013	17	0	7	0
18	FIELDDBUS PROPERTIES	IN2 SCALE UNIT	0014	18	0	29	0
19	FIELDDBUS PROPERTIES	FB VALUE IN 0	0015	19	0	0	0
20	FIELDDBUS PROPERTIES	FB VALUE IN 1	0016	20	1	1	1
21	FIELDDBUS PROPERTIES	FB VALUE IN 2	0017	21	2	2	2
22	FIELDDBUS PROPERTIES	FB VALUE IN 3	0018	22	27	27	27
23	FIELDDBUS PROPERTIES	FB VALUE OUT 0	0019	23	0	0	0
24	FIELDDBUS PROPERTIES	FB VALUE OUT 1	001A	24	1	1	1
25	FIELDDBUS PROPERTIES	FB VALUE OUT 2	001B	25	2	2	2
26	FIELDDBUS PROPERTIES	FB VALUE OUT 3	001C	26	3	3	3
27	FIELDDBUS PROPERTIES	–	001D	27	0	0	0
28	FIELDDBUS PROPERTIES	–	001E	28	0	0	0
22	LINKAGE PROPERTIES	FACTOR	0020	29	-99999999	99999999	1
23	LINKAGE PROPERTIES	DIVIDER	0021	30	1	99999999	1
24	LINKAGE PROPERTIES	ADDITIVE VALUE	0022	31	-99999999	99999999	0
25	LINKAGE PROPERTIES	DECIMAL POINT	0023	32	0	7	0
26	LINKAGE PROPERTIES	SCALE UNIT	0024	33	0	29	0
29	LINKAGE PROPERTIES	–	0025	34	0	0	0
30	LINKAGE PROPERTIES	–	0026	35	0	0	0
31	PRESELECTION VALUES	PRESELECTION 1	0028	B1	-99999999	99999999	1000
32	PRESELECTION VALUES	PRESELECTION 2	0029	B2	-99999999	99999999	2000
33	PRESELECTION VALUES	PRESELECTION 3	002A	B3	-99999999	99999999	3000
34	PRESELECTION VALUES	PRESELECTION 4	002B	B4	-99999999	99999999	4000

Continuation "Parameter / Indices / Serial Codes":

#	Menu	Name	Index (hex)	Serial Code	Min	Max	Default
35	PRESELECTION 1 MENU	SOURCE 1	002D	B5	0	2	0
36	PRESELECTION 1 MENU	MODE 1	002E	B6	0	7	0
37	PRESELECTION 1 MENU	HYSTERESIS 1	002F	B7	0	99999	0
38	PRESELECTION 1 MENU	PULSE TIME 1 (S)	0030	B8	0	60000	0
39	PRESELECTION 1 MENU	OUTPUT TARGET 1	0031	B9	0	6	1
40	PRESELECTION 1 MENU	OUTPUT POLARITY 1	0032	C0	0	1	0
41	PRESELECTION 1 MENU	OUTPUT LOCK 1	0033	C1	0	1	0
42	PRESELECTION 1 MENU	EVENT COLOR 1	0034	C2	0	3	0
43	PRESELECTION 1 MENU	–	0035	C3	0	0	0
44	PRESELECTION 1 MENU	–	0036	C4	0	0	0
45	PRESELECTION 2 MENU	SOURCE 2	0038	C5	0	2	0
46	PRESELECTION 2 MENU	MODE 2	0039	C6	0	7	0
47	PRESELECTION 2 MENU	HYSTERESIS 2	003A	C7	0	99999	0
48	PRESELECTION 2 MENU	PULSE TIME 2 (S)	003B	C8	0	60000	0
49	PRESELECTION 2 MENU	OUTPUT TARGET 2	003C	C9	0	6	2
50	PRESELECTION 2 MENU	OUTPUT POLARITY 2	003D	D0	0	1	0
51	PRESELECTION 2 MENU	OUTPUT LOCK 2	003E	D1	0	1	0
52	PRESELECTION 2 MENU	EVENT COLOR 2	003F	D2	0	3	0
53	PRESELECTION 2 MENU	–	0040	D3	0	0	0
54	PRESELECTION 2 MENU	–	0041	D4	0	0	0
55	PRESELECTION 3 MENU	SOURCE 3	0043	D5	0	2	0
56	PRESELECTION 3 MENU	MODE 3	0044	D6	0	7	0
57	PRESELECTION 3 MENU	HYSTERESIS 3	0045	D7	0	99999	0
58	PRESELECTION 3 MENU	PULSE TIME 3 (S)	0046	D8	0	60000	0
59	PRESELECTION 3 MENU	OUTPUT TARGET 3	0047	D9	0	6	3
60	PRESELECTION 3 MENU	OUTPUT POLARITY 3	0048	E0	0	1	0
61	PRESELECTION 3 MENU	OUTPUT LOCK 3	0049	E1	0	1	0
62	PRESELECTION 3 MENU	EVENT COLOR 3	004A	E2	0	3	0
63	PRESELECTION 3 MENU	–	004B	E3	0	0	0
64	PRESELECTION 3 MENU	–	004C	E4	0	0	0
65	PRESELECTION 4 MENU	SOURCE 4	004E	E5	0	2	0
66	PRESELECTION 4 MENU	MODE 4	004F	E6	0	7	0
67	PRESELECTION 4 MENU	HYSTERESIS 4	0050	E7	0	99999	0
68	PRESELECTION 4 MENU	PULSE TIME 4 (S)	0051	E8	0	60000	0
69	PRESELECTION 4 MENU	OUTPUT TARGET 4	0052	E9	0	6	4
70	PRESELECTION 4 MENU	OUTPUT POLARITY 4	0053	F0	0	1	0
71	PRESELECTION 4 MENU	OUTPUT LOCK 4	0054	F1	0	1	0
72	PRESELECTION 4 MENU	EVENT COLOR 4	0055	F2	0	3	0
73	PRESELECTION 4 MENU	–	0056	F3	0	0	0
74	PRESELECTION 4 MENU	–	0057	F4	0	0	0

Continuation "Parameter / Indices / Serial Codes":

#	Menu	Name	Index (hex)	Serial Code	Min	Max	Default
75	SERIAL MENU	UNIT NUMBER	0059	90	11	99	11
76	SERIAL MENU	SERIAL BAUD RATE	005A	91	0	3	3
77	SERIAL MENU	SERIAL FORMAT	005B	92	0	3	2
78	SERIAL MENU	SERIAL PROTOCOL	005C	F5	0	1	0
79	SERIAL MENU	SERIAL TIMER (S)	005D	F6	0	60000	0
80	SERIAL MENU	SERIAL VALUE	005E	F7	0	9	0
81	SERIAL MENU	MODBUS	005F	F8	0	247	0
82	SERIAL MENU	–	0060	F9	0	0	0
83	SERIAL MENU	–	0061	G0	0	0	0
84	ANALOG MENU	ANALOG SOURCE	0063	G1	0	2	0
85	ANALOG MENU	ANALOG FORMAT	0064	G2	0	2	0
86	ANALOG MENU	ANALOG START	0065	G3	-99999999	99999999	0
87	ANALOG MENU	ANALOG END	0066	G4	-99999999	99999999	10000
88	ANALOG MENU	ANALOG GAIN %	0067	G5	0	11000	10000
89	ANALOG MENU	ANALOG OFFSET %	0068	G6	-9999	9999	0
90	ANALOG MENU	–	0069	G7	0	0	0
91	COMMAND MENU	INPUT 1 ACTION	006B	G8	0	21	0
92	COMMAND MENU	INPUT 1 CONFIG.	006C	G9	0	3	2
93	COMMAND MENU	INPUT 2 ACTION	006D	H0	0	21	0
94	COMMAND MENU	INPUT 2 CONFIG.	006E	H1	0	3	2
95	COMMAND MENU	INPUT 3 ACTION	006F	H2	0	21	0
96	COMMAND MENU	INPUT 3 CONFIG.	0070	H3	0	3	2
97	COMMAND MENU	-	0071	H4	0	0	0
98	COMMAND MENU	-	0072	H5	0	0	0
99	COMMAND MENU	-	0073	H6	0	0	0
100	COMMAND MENU	-	0074	H7	0	0	0
101	DISPLAY MENU	START DISPLAY	0076	H8	0	6	0
102	DISPLAY MENU	SOURCE SINGLE	0077	H9	0	2	0
103	DISPLAY MENU	SOURCE DUAL TOP	0078	I0	0	2	0
104	DISPLAY MENU	SOURCE DUAL DOWN	0079	I1	0	2	1
105	DISPLAY MENU	LARGE DISPLAY	007A	I2	0	5	0
106	DISPLAY MENU	COLOR	007B	I3	0	2	0
107	DISPLAY MENU	BRIGHTNESS %	007C	I4	10	100	90
108	DISPLAY MENU	CONTRAST	007D	I5	0	2	1
109	DISPLAY MENU	SCREEN SAVER (S)	007E	I6	0	9999	0
110	DISPLAY MENU	UP-DATE-TIME (S)	007F	I7	5	9999	100
111	DISPLAY MENU	FONT	0080	I8	0	1	0
112	DISPLAY MENU	QUICKSTART BUTTON	0081	I9	0	1	0
113	DISPLAY MENU	–	0082	J0	0	0	0
114	DISPLAY MENU	–	0083	J1	0	0	0

6.2.1. Commands:

#	Command	Function	Index (hex)	Serial Code
0	FREEZE DISPLAY	Freeze actual display value	1000	54
1	KEY LOCK (TOUCH DISABLE)	Disable touch screen	1001	55
2	LOCK RELEASE	Release latching of all outputs/relays	1002	56
3	CLEAR MIN MAX	Reset of the min. / max. values	1003	57
4	SERIAL PRINT	Sending serial data (see SERIAL VALUE)	1004	58
5	TEACH PRESELECTION 1	Save current display value as PRESELECTION 1	1005	59
6	TEACH PRESELECTION 2	Save current display value as PRESELECTION 2	1006	60
7	TEACH PRESELECTION 3	Save current display value as PRESELECTION 3	1007	61
8	TEACH PRESELECTION 4	Save current display value as PRESELECTION 4	1008	62
9	SCROLL_DISPLAY	Display switching (see chapter 4.2 / Display representation during operation)	1009	63
10	CLEAR LOOP TIME	All set switching conditions are enabled	100A	64
11	Command 11 (not applicable)	N.A.	100B	65
12	START PRESELCTION	N.A.	100C	66
13	ACTIVATE DATA	N.A.	100D	67
14	STORE EEPROM	Save parameter values in EEPROM	100E	68
15	TESTPROGRAMM	N.A.	100F	
16	SET RED COLOUR	Switch display color to red. (Color can be changed by the event-dependent color switching in the PRESELECTION 1... 4)	1010	5:
17	SET GREEN COLOUR	Switch display color to green. (Color can be changed by the event-dependent color switching in the PRESELECTION 1... 4)	1011	5;
18	SET YELLOW COLOUR	Switch display color to yellow. (Color can be changed by the event-dependent color switching in the PRESELECTION 1... 4)	1012	5<
19	INCR. BRIGHTNESS	Display brightness is increased	1013	5=
20	DECR. BRIGHTNESS	Display brightness is reduced	1014	5>
21	Command 21 (not applicable)	N.A.	1015	5?
	
31	Command 31 (not applicable)	N.A.	101F	5I

6.2.2. Status Words:

Status	Function	Index (hex)	Serial Code
Bus Commands	Commands via PROFINET as a complete status word (each bit represents a command, bit no. of the respective command see column # in table above)	3002	}4
Extern Commands	Commands via the control inputs Ctr. In. 1...3	3004	}2
Output Status	State of the control outputs Ctrl.Out 1...4, Rel. 1 and 2	3010	}6
Error Status	Errorr status	3014	}:

6.2.3. Variables (Actual values):

Actual value	Function	Index (hex)	Serial Code
Scaled_Result_FB_Value_1	Scaled process data value 1 (display value)	4800	:0
Scaled_Result_FB_Value_2	Scaled process data value 2 (display value)	4801	:1
Scaled_Result_Linkage	Scaled linked display value	4802	:2
Unscaled_FB_Value_1	Process data value 1 (as received via PROFINET)	4000	:3
Unscaled_FB_Value_2	Process data value 2 (as received via PROFINET)	4001	:4
Minimum_Value	Saved minimum display value	—	:8
Maximum_Value	Saved maximum display value	—	:9
Error_Status	Error status	—	;0
Analog_Out_Voltage	Analog output voltage (only with option AO)	—	;3
Analog_Out_Current	Analog output current (only with option AO)	—	;4
Cmd_State_new	State of the digital control inputs Ctrl.In 1...5	—	<7

6.3. Dimensions

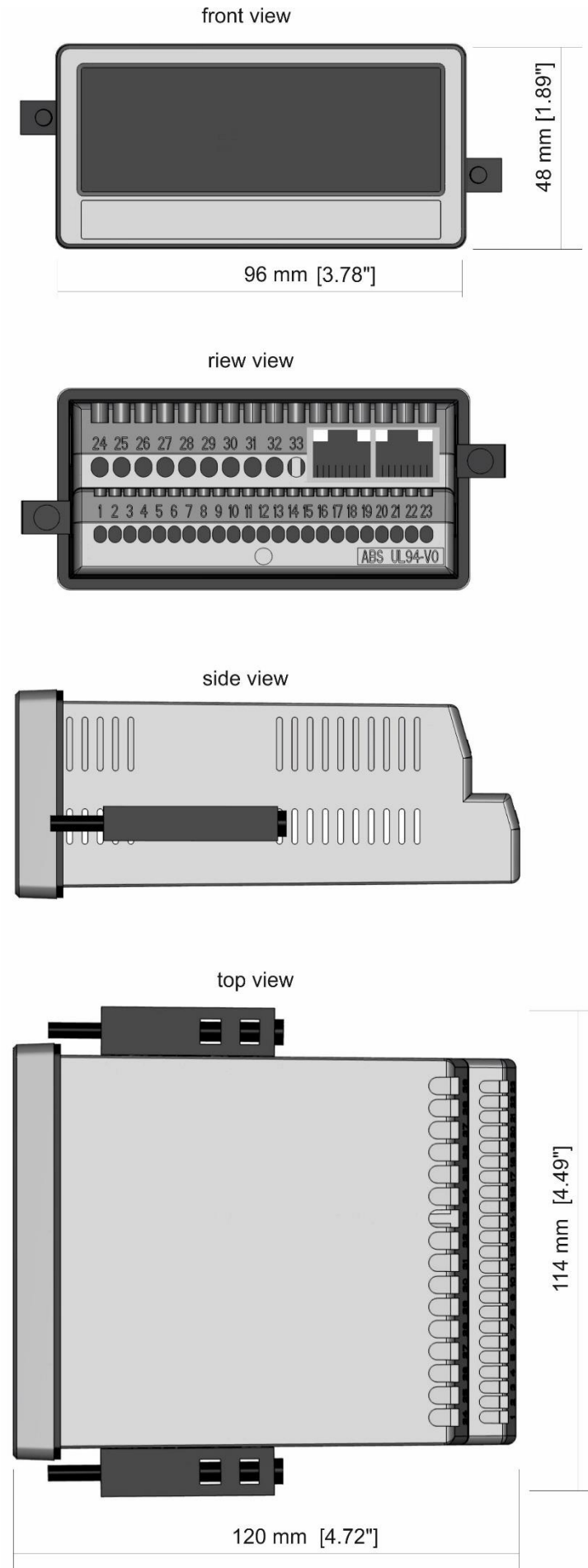

6.4. Technical Specifications

Technical Specification:		
Connection:	Connection type:	Screw terminals, 1,5 mm ² / AWG 16
Power supply DC:	Input voltage:	18 ... 30 VDC
	Protection circuit:	Reverse polarity protection
	Consumption:	ca. 100 mA (unloaded)
	Fuse protection:	extern: T 0,5 A
Power supply AC: (Option AC)	Input voltage:	115 ... 230 VAC ± 10%, 50 ... 60 Hz
	Power consumption:	ca. 3 VA (unloaded)
	Fuse protection:	extern: T 0,1A
Auxiliary voltage output:	With DC supply:	24 VDC (approx. 1 V lower than input voltage), max. 250 mA or 5 VDC (± 15%), max. 250 mA
	With AC supply:	24 VDC (± 15%) (max. 150 mA up to 45°C resp. 113°F/ 80 mA from 45°C resp. 113°F) or 5 VDC (± 15%), max. 250 mA
PROFINET interface:	Connection:	2 Ethernet Ports RJ45 with integrated switch and galvanic isolation
	Data transfer rate:	100 Mbit/s full duplex
	Communication:	PROFINET IO Device PROFINET RT with cyclic and acyclic data exchange
	Conformance-Class:	B
	Netload-Class:	III
Control inputs:	Number of inputs:	3
	Format:	HTL, PNP (Low 0 ... 3 V, High 9 ... 30 V)
	Frequency:	max. 1 kHz
	Reaction time:	1 ms
	Load:	max. 2 mA at 24VDC
Analog output: (Option AO/AR)	Configuration:	Current or voltage operation
	Voltage output:	-10...+10 V (max. 2 mA)
	Current output:	0/4 ... 20 mA (burden: max. 270 Ohm)
	Resolution:	16 Bit
	Accuracy:	± 0,1 % 0°C ... +45°C / ± 0,1 % +32°F ... +113°F ± 0,15 % -20°C ... 0°C and +45°C ... +60°C / ± 0,15 % -4°F ... +32°F and +113°F ... +140°F
	Reaction time:	approx. 50 ms
Control outputs: (Option AO/AR/CO/CR)	Number of outputs:	4
	Format / level:	5 ... 30 V (depends on the COM+ voltage), PNP
	Output current:	max. 200 mA
	Reaction time:	approx. 50 ms
Relay outputs: (Option RL)	Number of outputs:	2
	Configuration:	COM, NO, NC (potential free)
	AC-Switching capacity:	max. 250 VAC / 3 A / 750 VA
	DC-Switching capacity:	max. 150 VDC / 2 A / 50 W
	Reaction time:	approx. 50 ms
Serial interface: (Option AO/AR/CO/CR)	Format (Option AO/CO):	RS232
	Format (Option AR/CR)	RS485
	Baud rate:	9600, 19200 or 38400 Baud
	Protocol:	Lecom or Modbus RTU

Continuation "Technical Specifications":

Display:	Type: Display range: Digit height (single + dual): Digit height (large display) Color: Operation:	Graphic-LCD with backlight 8 digits plus sign (-99999999 ... 99999999) 13 mm / 0.51 inch 26 mm / 1,02 inch red/ green/ yellow (switchable) touch screen (resistive)
Housing:	Material: Mounting: Dimensions (w x h x d): Cut out (w x h): Protection class: Weight:	ABS, UL 94 V-0 Panel 96 x 48 x 116 mm / 3.78. x 1.89 x 4.56 inch 91 x 43 mm / 3.58 x 1.69 inch IP65 (front), IP20 (rear) approx. 200 g
Ambient temperature:	Operating: Storage:	-20°C ... +60°C resp. -4 ... 140°F non condensing -25°C ... +70°C resp. -13 ... 158°F
Ambient conditions:	Altitude: Humidity: Pollution Degree:	max. 2000 m (6560 ft) above sea level max. 80% relative humidity up to 30°C / 86°F 2
Conformity and standards:	EMC 2014/30/EU: LV 2014/35/EU: (Only for option AC and RL) RoHS (II) 2011/65/EU RoHS (III) 2015/863:	EN 61326-1: 2013 for industrial location EN 55011: 2016 + A1: 2017 + A11: 2020 Class A EN 61010-1: 2010 + A1:2019 + AC: 2019-04 EN IEC 61010-2-201: 2018 EN IEC 63000: 2018