

65 Watts

- Medical & IT Safety Approvals
- Energy Efficiency Level VI
- 4th Edition Medical EMC
- IP32 Environmental Rating
- Class I and Class II Versions
- <0.21 W Standby Power
- 0 °C to 60 °C Operation
- Low Earth Leakage Current
- 3 Year Warranty



Dimensions:

ALM65:

4.94 x 2.19 x 1.32" (125.5 x 55.5 x 33.5 mm)

The ALM65 series of medical external power supplies is fully approved to international medical safety standards. It has been designed with very high efficiency and low standby power, enabling it to meet the latest environmental legislation. The unit has a fully sealed enclosure complying with IP32 and a smooth surface finish making it easier to wipe down in a clinical setting.

Models & Ratings

Output Power	Output Voltage	Output Current	Total Regulation	Efficiency ⁽¹⁾	Model Number ^(2,3,4)
65 W	12.0 V	5.40 A	±5%	88%	ALM65US12
	15.0 V	4.30 A		88%	ALM65US15
	19.0 V	3.40 A		88%	ALM65US19
	24.0 V	2.70 A		88%	ALM65US24
	48.0 V	1.35 A		88%	ALM65US48

Notes

1. Typical average of efficiencies measured at 25%, 50%, 75% and 100% load and 115VAC input.
2. For class II versions, add suffix 'C2-8' to the end of the part number e.g. ALM65US24C2-8.
3. For optional input connector retention clip add suffix '-A' to the model number, e.g. ALM65US24-A (not available for C2 versions)
4. 5.5 x 2.1 mm output connector add suffix B1 to the part number, e.g. ALM65US24-B1, ALM65US24C2-8B1, ALM65US24-AB1.

Mechanical Details

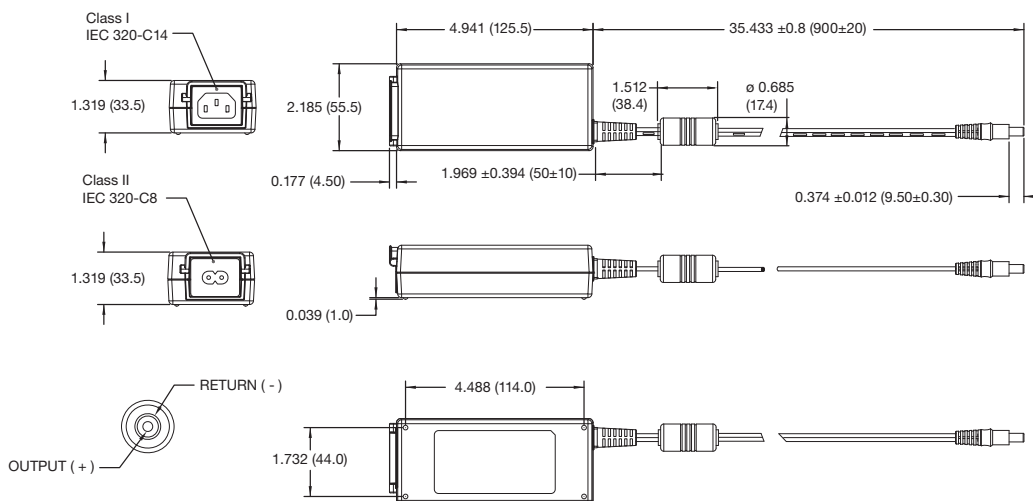

Notes

1. All dimensions shown in inches (mm). Tolerance is 0.02 (0.5) maximum, except output cable length.
2. Output connector: 5.5 outer diameter, 2.5 mm inner diameter with centre positive.
3. Weight: 0.68 lbs (308 g) approx.
4. For European mains lead order part EU-MAINS-IEC for C14 versions, or EU-MAINS-8 for C8 versions.
5. For UK mains lead order part UK-MAINS-IEC for C14 versions, or UK-MAINS-8 for C8 versions.
6. For US mains lead order part US-MAINS-IEC for C14 versions, or US-MAINS-8 for C8 versions.

Input

Characteristic	Minimum	Typical	Maximum	Units	Notes & Conditions
Input Voltage	80		264	VAC	Derate linearly from 100% load at 90 VAC to 80% load at 80 VAC
Input Frequency	47		63	Hz	
Input Current		1.2/0.6		A	Measured at 115/230 VAC
Inrush Current			60/120	A	115/230 VAC, cold start at 25 °C
Power Factor					EN61000-3-2 Class A
Earth Leakage Current			250	µA	264 VAC, 60 Hz
No Load Input Power			0.21	W	
Input Protection	T3.15A/250 VAC internal fuse in both line				

Output

Characteristic	Min.	Typ.	Max.	Units	Notes & Conditions
Output Voltage	12		48	VDC	See Models and Ratings table
Initial Set Accuracy			±2	%	At 50% load
Minimum Load					No minimum load required
Start Up Delay			2	s	
Start Up Rise Time			40	ms	
Hold Up Time	20			ms	Full load and 230 VAC
Line Regulation			±0.5	%	
Total Regulation			±5	%	
Transient Response			4	%	Maximum deviation, recovering to less than 1% within 500 µs for 25% step load
Ripple and Noise			1.5	% pk-pk	20 MHz bandwidth, measured with 20 MHz Bandwidth and 10 µF electrolytic in parallel with 0.1 µF ceramic capacitor.
Overshoot			10	%	At turn on / turn off
Overload Protection	115		175	%	
Overvoltage Protection	145		170	%	Recycle mains to reset
Short Circuit Protection	Trip and restart (hiccup), auto resetting				
Thermal Protection	Measured internally, auto resetting				
Temperature Coefficient		0.05		%/°C	
Patent Leakage Current			100	µ A	264 VAC, 60 Hz

Environmental

Characteristic	Minimum	Typical	Maximum	Units	Notes & Conditions
Operating Temperature	0		+60	°C	Derate from 100% load at 40 °C to 50% load at 60 °C
Cooling	Natural convection				
Operating Humidity	5		90	%RH	Non-condensing
Storage Temperature	-40		+80	°C	
Operating Altitude			5000	m	
Shock	IEC68-2-27, 30 g, 11 ms half sine, 3 times in each of 6 axes				
Vibration	IEC68-2-6, 10-500 Hz, 2 g 10 mins/sweep, 60 mins for each of 3 axes				

Derating Curve

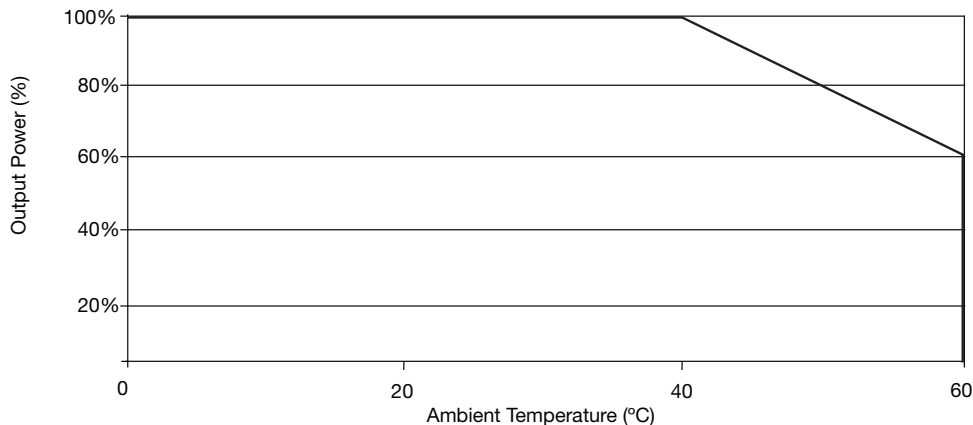

General

Characteristic	Minimum	Typical	Maximum	Units	Notes & Conditions
Efficiency	88			%	See Models and Ratings table and curves.
Isolation: Input to Output Input to Ground Output to Ground			4000	VAC	2 x MOPP
			1500	VAC	1 x MOPP (Class I versions only)
			500	VAC	Class I versions only
Switching Frequency		65 KHz		kHz	PWM
Power Density		4.55		W/in ³	
Mean Time Between Failure		>300		kHrs	MIL-HDBK-217F at 25 °C GB
Weight		0.68 (308)		lb (g)	

Efficiency Curves

ALM65US12

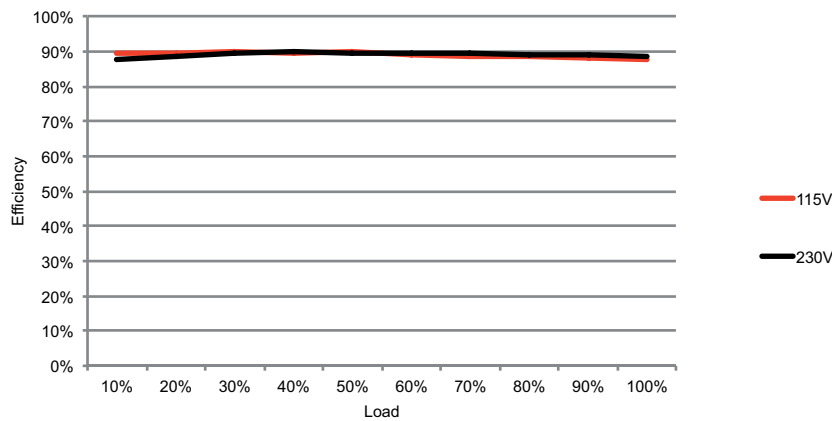

ALM65US24

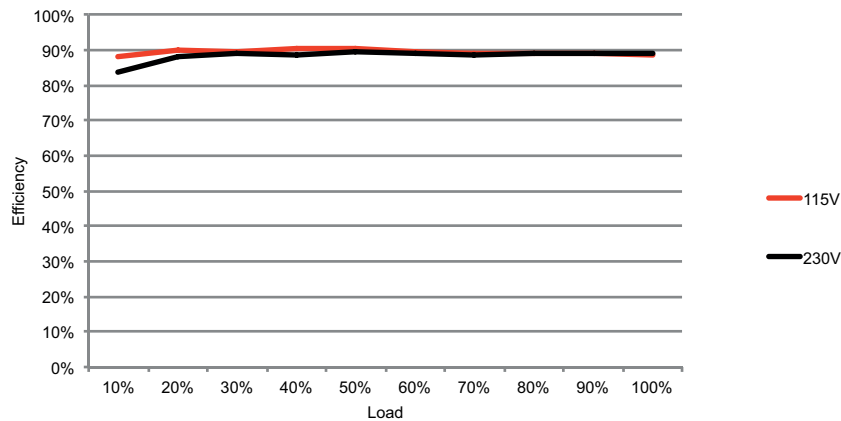

EMC: Emissions

Phenomenon	Standard	Test Level	Notes & Conditions
Emissions	EN55032, EN55011	Level B	Conducted & Radiated
Harmonic Current	EN61000-3-2	Class A	
Voltage Flicker	EN61000-3-3		

EMC: Immunity

Phenomenon	Standard	Test Level	Criteria	Notes & Conditions
ESD	EN61000-4-2	3	A	±15 kV air/±8 kV contact
Radiated	EN61000-4-3	10 V/m	A	80-2700 MHz. IEC60601-1-2 Ed.4 at other frequencies
EFT/Burst	EN61000-4-4	3	A	
Surge	EN61000-4-5	Installation Class 3	A	
Conducted	EN61000-4-6	10 V	A	
Magnetic Fields	EN61000-4-8	4	A	
Dips and Interruptions	EN61000-4-11	Dip: 30% 500 ms	A/B	High Line/Low Line
		Dip: 60% 200 ms	A/B	High Line/Low Line
		Dip: 80% 5000 ms	B	
	EN60601-1-2	Dip: 100% 5000 ms	B	
		Dip: 30% 25 AC Cycles	A	230 VAC 100% load, 100 VAC 75%
		Dip: 60% 5 AC Cycles	A	230 VAC 100% load, 100 VAC 20%
		Dip: 100% 0.5 AC Cycles	A	At 8 angles
		Int.: >95% 5000 ms	B	

Safety Approvals

Safety Agency	Safety Standard	Notes & Conditions
UL	UL62368-1	Information Technology
TUV	EN62368-1	
CB	IEC60950-1 & IEC62368-1	
CE	LVD	
UL	ANSI/AAMI ES 60601-1	Medical
CSA	CSA C22.2 No. 60601	
TUV	EN60601-1	
CB	IEC60601-1	
Others	CCC, KC & RCM	May require additional importer information

Mechanical Details

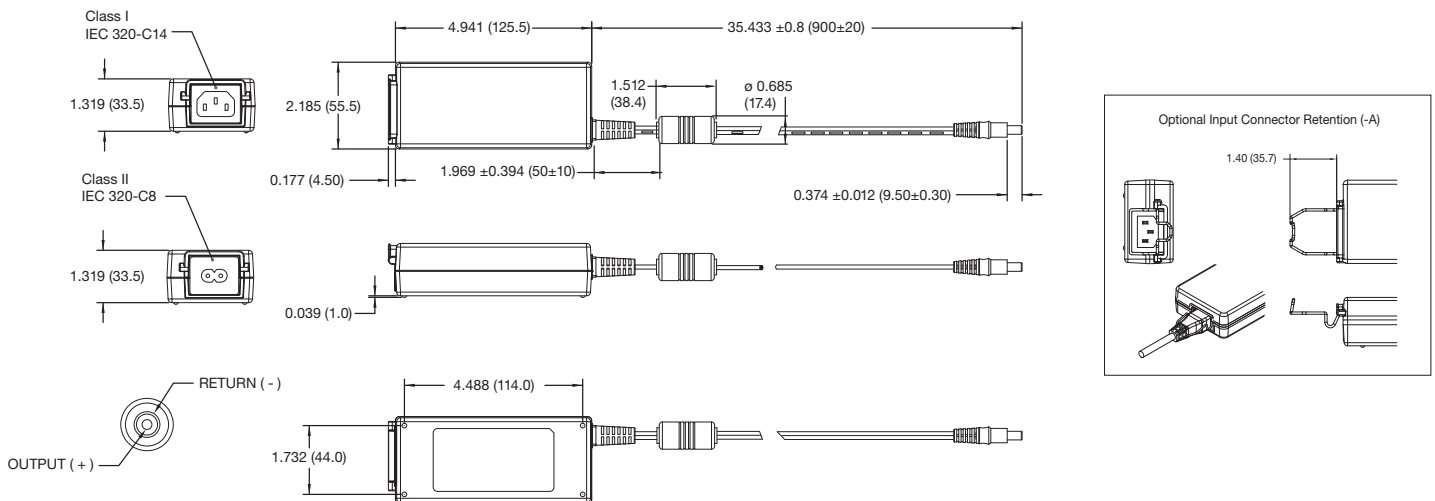

Notes

- All dimensions shown in inches (mm). Tolerance is 0.02 (0.5) maximum, except output cable length.
- Output connector: 5.5 outer diameter, 2.5 mm inner diameter with centre positive.
- Weight: 0.68 lbs (308 g) approx.
- For European mains lead order part EU-MAINS-IEC for C14 versions, or EU-MAINS-8 for C8 versions.
- For UK mains lead order part UK-MAINS-IEC for C14 versions, or UK-MAINS-8 for C8 versions.
- For US mains lead order part US-MAINS-IEC for C14 versions, or US-MAINS-8 for C8 versions.