



ITT

Interconnect Solutions
Cannon, VEAM, BIW

Defining **innovative**
aviation, military, and
industrial circulars since the DC-1,
over **70 years** ago



Engineered for life



A

Circular

KPSE High performance crimp contact connectors

KPSE High performance crimp contact connectors

- High performance
- Crimp termination
- Closed entry socket contacts

Series KPSE environmental, miniature circular, quick disconnect connectors are designed for the exacting requirements of today's electronic industry.

They are intermateable, intermountable and interchangeable with all connectors manufactured acc. to MIL-C-26482 and VG95328.

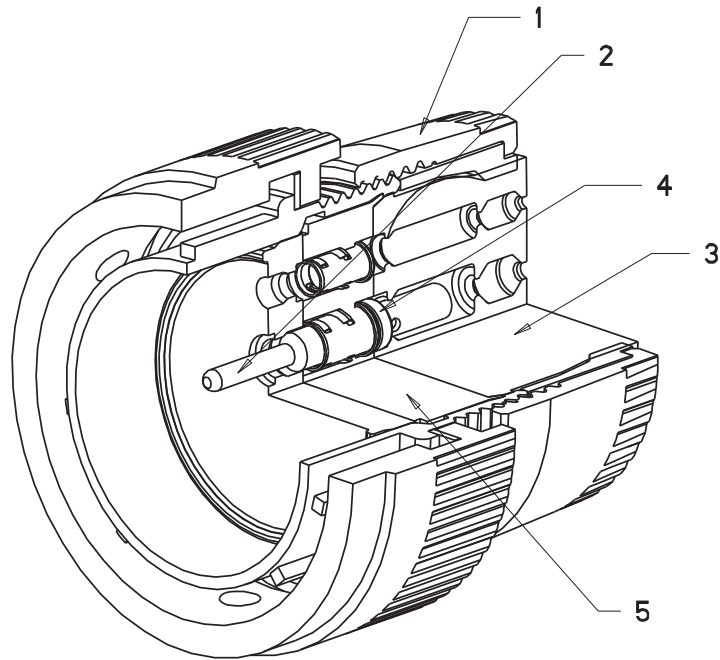

1 Standard MIL-C-26482 mates with any connector designed to MIL-C-26482 and VG 95328.

2 Crimp, snap-in contacts are designed to MIL-C-39029 and can be crimped with the standard M22520/1 crimp tool.

Closed-entry socket contacts eliminate damage from abuse by test probes and help to correct any misaligned pins during engagement

Contact insertion is accomplished from the rear of the connector. When the contact is fully inserted, the clip tines snap securely behind the contact shoulder.

Contact extraction is accomplished with a front-inserted tool. Pressing the tool plunger pushes the contact out through the rear of the connector.

3 Monobloc insulator does not leave any access to moisture and avoids interfacial empty space.

4 Contact retaining clip is completely encased in a tough plastic wafer to protect the clip from damage

Complete moisture sealing is achieved by combining four seals: shell, peripheral, interfacial and wire seals

Shell Seal is effected when the plug shell pushes against the sealing ring in the receptacle when the connectors are mated.

Peripheral Seal around the edge of the pin insulator is designed so that mating the connector puts tension on the seal and greatly reduces compression set.

Interfacial Seal is achieved by the insulator faces meeting when the plug and receptacle are mated.

Wire Seal is accomplished by a multiple ripple design, exceeding the wire sealing requirements of MIL-C-26482.

5 Positive insert-to-shell mechanical retention with hard plastic wafer firmly locked into a groove in the shell, in addition to a strong adhesive bond between the insert and shell.



A

Circular

KPSE High performance crimp contact connectors

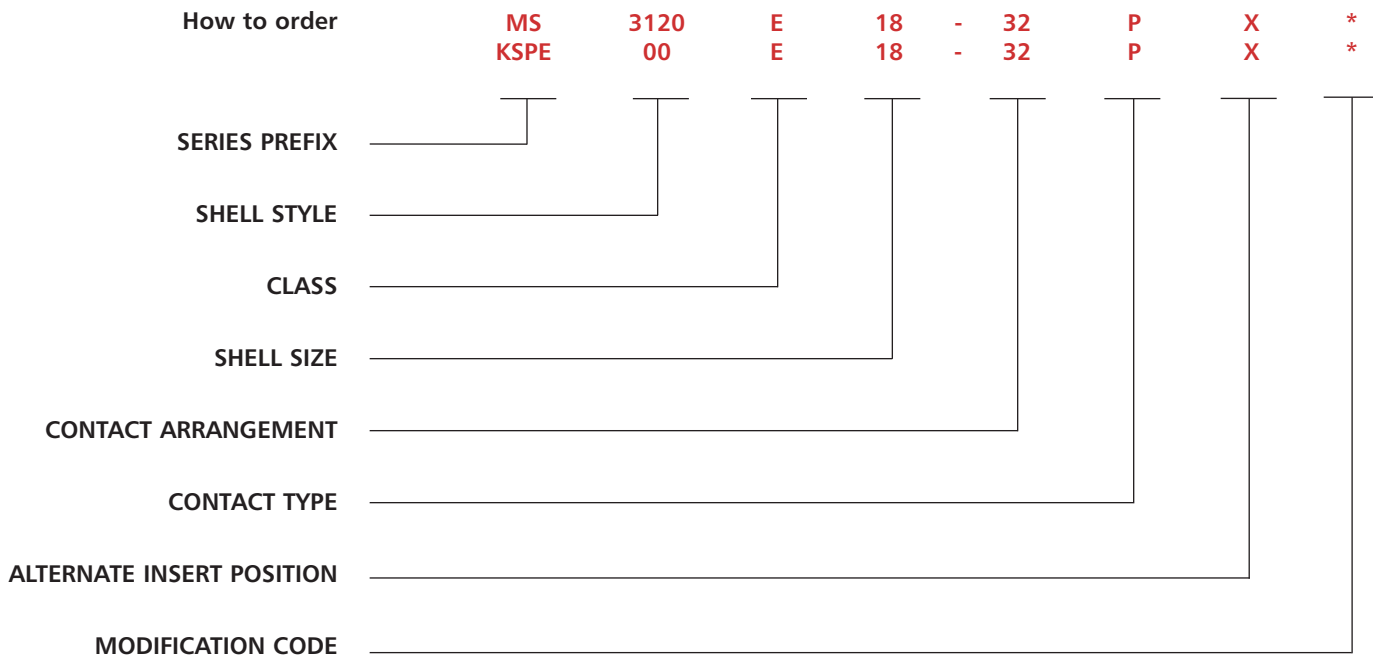

SERIES PREFIX

- KPSE -ITT Cannon prefix
- KPSR - ITT Cannon RoHS prefix
- MS -MIL-C-26482 prefix

SHELL STYLE

- ITT Cannon designation
- 00 -wall mounting receptacle
- 01 -cable connecting plug
- 02 -box mounting receptacle (class E only)
- 06 -straight plug
- 07 -jam nut receptacle
- 08 -90° angle plug

MS DESIGNATION

- 3120 - Wall mounting receptacle
- 3121 - Cable connecting receptacle
- 3122 - Box mounting receptacle
- 3124 - Jam nut receptacle
- 3126 - Straight plug

CLASS

- A - general duty (not MS approved)
- B - general duty with strain relief (not MS approved)
- E - with a grommet seal (MS specification)
- F - grommet seal with strain relief (MS specification)
- J - gland seal with strain relief for jacketed cable (U.S. version) (not MS approved)
- P -for potting (MS specification) (U.S. version)

SHELL SIZES

8, 10, 12, 14, 16, 18, 20, 22, and 24

CONTACT ARRANGEMENTS

see page A-41

CONTACT TYPE

- P -Pin
- S -Socket

ALTERNATE INSERT POSITION

W, X, and Z (omit for normal), see page A-42

MODIFICATION CODE (Include Same Codes as KPT)

- A34 - Electroless nickel hardware, RoHS compliant (European version)
- A71 - Electroless nickel hardware (U.S. version RoHS compliant after 11/1/07))
- A206 - Black zinc cobalt hardware (U.S. version, RoHS compliant)
- A232 - Black zinc cobalt hardware (European version, RoHS compliant)
- A233 - Green zinc cobalt hardware (European version)
- A408 - Extended Life Contact - Gold over Nickel
- DN - Shrink boot adapter for shell styles 00, 01, 06 and 07 (Class E only)
- DZ - Endbell for shielding braids and shrink boots. (Class E only)
- 07 - Clear chromate over cadmium hardware (U.S. version)
- 16 - Lanyard release (applicable to plug only) (U.S. version)
- 23 - Ground springs (applicable to plug only)
- F42 - connectors without endbell and related parts

- P9 = PG9 for shell #10 M12 = M12x1,5 for shell #10
- P11 = PG11 for shell #12 M16 = M16x1,5 for shell #12
- P13 = PG13,5 for shell #14 M20 = M20x1,5 for shell #14
- P16 = PG16 for shell #16 M25 = M25x1,5 for shell #16
- P21 = PG21 for shell #18 M25 = M25x1,5 for shell #18
- P21 = PG21 for shell #20 M25 = M25x1,5 for shell #20
- P21 = PG21 for shell #22 M32 = M32x1,5 for shell #22
- P29 = PG29 for shell #24 M32 = M32x1,5 for shell #24

Consult factory for other modifications. **Omit first digit (0) of shell style indication when using a modification code.**

Dimensions shown in inches (mm)
Specifications and dimensions subject to change





A

Circular

Contact Arrangements

LEGEND

- ▲ KPT
- ◆ KPSE
- △ Authorized per MIL-C-26482 (NAVY)
- Not MS approved ITTC proprietary
- ★ VG95328

Drawing not to scale; face view of pin insert shown (socket view is opposite)

Shell Size	No. of Contacts	Service Rating
Shell Size 8		
	▲ ▲ 8-2 2-#20	I
	▲ ▲ 8-3 3-#20	I
	◆ ★ 8-3A 3-#20	I
	▲ ▲ 8-4 4-#20	I
	▲ ◆ ▲ 8-33 3-#20	I
Shell Size 10		
	▲ 10-7 7-#20	I
	▲ ◆ ▲ ★ 10-6 6-#20	I
	▲ ▲ 10-98 6-#20	I
Shell Size 12		
	▲ ◆ ▲ ★ 12-3 3-#16	II
	▲ ▲ 12-8 8-#20	I
	▲ ◆ 12-14 14-#20	I
	▲ ◆ ▲ ★ 12-10 10-#20	I
Shell Size 14		
	▲ ◆ ▲ ★ 14-5 5-#16	II
	▲ ◆ ▲ ★ 14-12 8-#20 4-#16	I
	▲ ◆ ▲ ★ 14-15 14-#20 1-#16	I
Shell Size 16		
	▲ ◆ ▲ ★ 16-8 8-#16	II
	▲ ◆ ▲ ★ 16-23 22-#20 1-#16	I
	▲ ◆ ▲ ★ 16-26 26-#20	I
	▲ ▲ 16-99 21-#20 2-#16	I
Shell Size 18		
	▲ ◆ ▲ ★ 18-11 11-#16	II
	▲ ● 18A28 26-#20 2-#16	I
Shell Size 20		
	▲ ▲ 20-16 16-#16	II
	▲ ◆ ▲ ★ 20-6 5-#12*	I
	▲ ▲ 20-24 24-#20	I
	▲ ◆ ▲ ★ 20-39 37-#20 2-#16	I
	▲ ◆ ▲ ★ 20-41 41-#20	I
Shell Size 22		
	▲ ◆ ▲ ★ 22-21 21-#16	II
	▲ ▲ 22-32 32-#20	I
	▲ ▲ 22-34 34-#20	I
20A-6*		
	▲ ● 22-36 36-#20	I
	▲ ▲ ◆ ★ 22-41 27-#20 14-#16	I
	▲ ◆ ▲ ★ 22-55 55-#20	I
Shell Size 24		
	▲ ● 24A57 55-#20 2-#12	I
	▲ ◆ ▲ ★ 24-61 61-#20	I

Dimensions shown in inches (mm)
Specifications and dimensions subject to change



A

Circular

Alternate Insert Positions

Face view of pin inserts

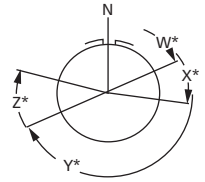

The five positions (W,X,Y,Z and Normal) differ in degree or rotation for various sizes and arrangements

No. of Contacts	Shell Size	Arr. No.	W	Degrees of Rotation			
				X	Y	Z	
2	8	8-2	58	122	-	-	
3	8	8-3	60	210	.-	-	
3	8	8-3A*	60	-	-	-	
3	8	8-33	90	-	-	-	
3	12	12-3	-	-	180	-	
4	8	8-4	45	-	-	-	
5	14	14-5	40	92	184	273	
5	14	14-22	**	**	**	**	
5	20	20A-6*	90	180	270	-	
6	10	10-6	90	-	-	-	
6	10	10-98	90	180	240	270	
7	10	10-7*	**	**	**	**	
8	12	12-8	90	112	203	292	
8	16	16-8	54	152	180	331	
10	12	12-10	60	155	270	295	
11	18	18-11	62	119	241	340	
12	14	14-12	43	90	-	-	
14	12	12-14*	**	**	**	**	
15	14	14-15	17	110	155	234	
16	20	20-16	238	318	333	347	
18	14	14-18	15	90	180	270	
19	14	14-19	30	165	315	-	
21	22	22-21	16	135	175	349	
23	16	16-23	158	270	-	-	
23	16	16-99	66	156	223	340	
24	20	20-24	70	145	215	290	
26	16	16-26	60	-	275	338	
28	18	18A26*	-	-	-	-	
30	18	18-30	180	193	285	350	
32	18	18-32	85	138	222	265	
32	22	22-32	72	145	215	288	
34	22	22-34	62	142	218	298	
36	22	22-36*	72	144	216	288	
39	20	20-39	63	144	252	333	
41	20	20-41	45	126	225	-	
41	22	22-41	39	135	264	-	
55	22	22-55	30	142	226	314	
57	24	24A57*	90	180	270	324	
61	24	24-61	90	180	270	-	

* Contact arrangements not MIL-C-26482 qualified

† Not available in KPSE

LA, LBF, LE, LJ and LP are connector overall lengths





A

Circular

Wall Mounting Receptacles

MS3110 (MS service class E,F,J,P)
MS3120 (MS service class E,F,P)

KPT00
KPSE00

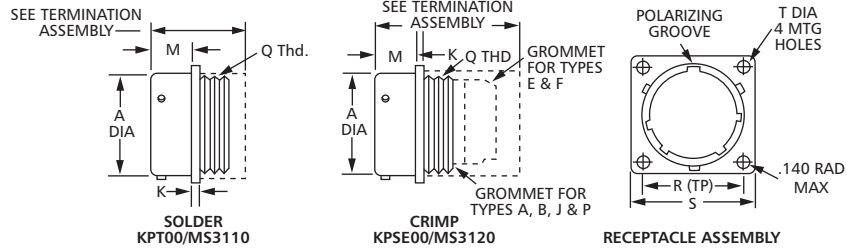
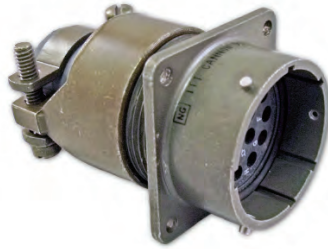

Shell Size	A ±.003 (±.08)	K ±.016 (±.41)	M +.031 (+.79) -.000 (.00)	R* (TP)	S Max.	T ±.005 (±.13)	Q Thread Class 2A
†8	.471 (11.96)	.062 (1.57)	.431 (10.95)	.594 (15.09)	.828 (21.03)	.120 (3.05)	7/16-28UNEF
10	.588 (14.96)	.062 (1.57)	.431 (10.95)	.719 (18.26)	.954 (24.23)	.120 (3.05)	9/16-24UNEF
12	.748 (19.00)	.062 (1.57)	.431 (10.95)	.812 (20.62)	1.047 (26.59)	.120 (3.05)	11/16-24UNEF
14	.873 (22.17)	.062 (1.57)	.431 (10.95)	.906 (23.01)	1.141 (28.98)	.120 (3.05)	13/16-20UNEF
16	.998 (25.35)	.062 (1.57)	.431 (10.95)	.969 (24.61)	1.234 (31.34)	.120 (3.05)	15/16-20UNEF
18	1.123 (28.52)	.062 (1.57)	.431 (10.95)	1.062 (26.97)	1.328 (33.73)	.120 (3.05)	1-1/16-18UNEF
20	1.248 (31.70)	.094 (2.39)	.556 (14.12)	1.156 (29.36)	1.453 (36.91)	.120 (3.05)	1-3/16-18UNEF
22	1.373 (34.87)	.094 (2.39)	.556 (14.12)	1.250 (31.75)	1.578 (40.08)	.120 (3.05)	1-5/16-18UNEF
24	1.498 (38.05)	.094 (2.39)	.589 (14.96)	1.375 (34.92)	1.703 (43.26)	.147 (3.73)	1-7/16-18UNEF

† Not available in KPSE *(TP) located within .010 T.P. with respect to diameter A and master keyway.

Receptacles with Termination Assemblies

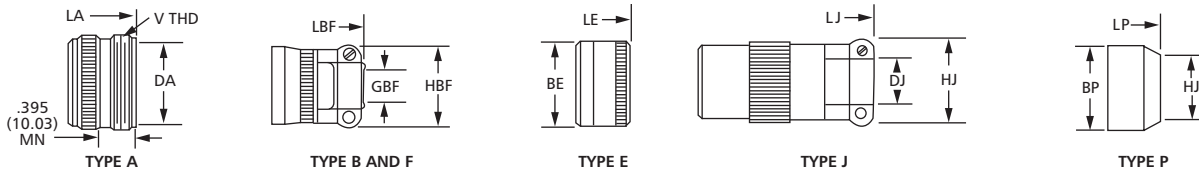

Shell Size	DA Min.	TYPE A		TYPE B and F			TYPE E	
		LA Max.	V Thread Class 2A	GBF Min.	HBF Max.	LBF Max.	BE Max.	LE Max.
†8	.335 (8.51)	1.58 (40.00)	1/2-28UNEF	.115 (2.92)	.828 (21.03)	1.922 (48.82)	.608 (15.44)	1.328 (33.73)
10	.466 (11.84)	1.58 (40.00)	5/8-24UNEF	.178 (4.52)	.891 (22.63)	1.922 (48.82)	.734 (18.64)	1.328 (33.73)
12	.591 (15.01)	1.58 (40.00)	3/4-20UNEF	.302 (7.67)	1.016 (25.81)	1.922 (48.82)	.858 (21.79)	1.328 (33.73)
14	.700 (17.90)	1.58 (40.00)	7/8-20UNEF	.365 (9.27)	1.141 (28.98)	1.922 (48.82)	.984 (24.99)	1.328 (33.73)
16	.830 (21.08)	1.58 (40.00)	1-20UNEF	.490 (12.45)	1.203 (30.56)	2.047 (51.99)	1.110 (28.19)	1.328 (33.73)
18	.948 (24.08)	1.58 (40.00)	1-3/16-18UNEF	.615 (15.62)	1.469 (37.31)	2.078 (52.78)	1.234 (31.34)	1.328 (33.73)
20	1.043 (26.49)	1.728 (43.89)	1-3/16-18UNEF	.615 (15.62)	1.469 (37.31)	2.344 (59.54)	1.360 (34.54)	1.531 (38.89)
22	1.198 (30.43)	1.728 (43.89)	1-7/16-18UNEF	.740 (18.80)	1.656 (42.06)	1.344 (34.14)	1.484 (37.69)	1.531 (38.89)
24	1.293 (32.84)	1.738 (44.15)	1-7/16-18UNEF	.790 (20.07)	1.750 (44.45)	2.406 (61.11)	1.610 (40.49)	1.594 (40.49)

Shell Size	TYPE J			TYPE P		
	DJ Max./Min.	HJ Max.	LJ Max.	BP Max.	DP Min.	LP Max.
†8	.230/.168 (5.84/4.27)	.828 (21.03)	2.271 (57.68)	.608 (15.44)	.317 (8.05)	1.453 (36.91)
10	.312/.205 (7.92/5.21)	.891 (22.63)	2.271 (57.68)	.734 (18.64)	.434 (11.02)	1.453 (36.91)
12	.442/.338 (11.23/8.59)	1.016 (25.81)	2.411 (61.24)	.858 (21.79)	.548 (13.92)	1.453 (36.91)
14	.539/.416 (13.56/10.57)	1.141 (28.98)	2.599 (66.01)	.984 (24.99)	.673 (17.09)	1.453 (36.91)
16	.616/.550 (15.65/13.97)	1.203 (30.56)	2.943 (74.75)	1.110 (28.19)	.798 (20.27)	1.453 (36.91)
18	.672/.600 (17.07/15.24)	1.469 (37.31)	3.172 (80.57)	1.234 (31.34)	.899 (20.83)	1.453 (36.91)
20	.747/.634 (18.97/16.13)	1.469 (37.31)	3.610 (91.69)	1.360 (34.54)	1.024 (26.01)	1.672 (42.47)
22	.846/.670 (21.49/17.02)	1.656 (42.06)	3.766 (95.66)	1.484 (37.69)	1.149 (29.18)	1.672 (42.47)
24	.894/.740 (22.71/18.80)	1.750 (44.45)	3.985 (101.22)	1.610 (40.89)	1.274 (32.36)	1.734 (44.04)

† Not available in KPSE
LA, LBF, LE, LJ and LP are connector overall lengths

Dimensions shown in inches (mm)
Specifications and dimensions subject to change



Cannon KPT/KPSE MIL-C-26482 Series I Connectors



Circular

MS3111 (MS service class E,F,J,P)
MS3121 (MS service class E,F,P)

KPT01
KPSE01

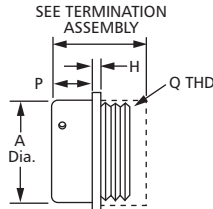

SOLDER
KPT01/MS3111

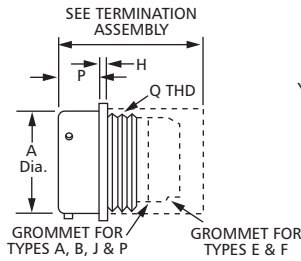

CRIMP
P KPSE01/MS3121

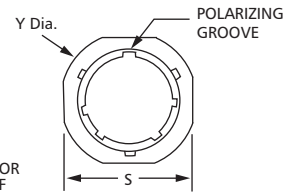

PLUG ASSEMBLY

Shell Size	A ±.003 (±.08)	HJ ±.016 (±.41)	+0.031 (+.79) -.000 (-.00)	S Max.	Y Max.	Q Thread Class 2A
†8	.471 (11.96)	.094 (2.39)	.400 (10.16)	.828 (21.03)	.958 (24.33)	7/16-28UNEF
10	.588 (14.94)	.094 (2.39)	.400 (10.16)	.954 (24.23)	1.082 (27.48)	9/16-24UNEF
12	.748 (19.00)	.094 (2.39)	.400 (10.16)	1.047 (26.59)	1.176 (29.87)	11/16-24UNEF
14	.873 (22.17)	.094 (2.39)	.400 (10.16)	1.141 (24.99)	1.270 (32.26)	13/16-20UNEF
16	.998 (25.35)	.094 (2.39)	.400 (10.16)	1.110 (28.98)	1.364 (34.65)	15/16-20UNEF
18	1.123 (28.52)	.094 (2.39)	.400 (10.16)	1.234 (31.34)	1.458 (37.03)	1-1/16-18UNEF
20	1.248 (31.70)	.115 (2.92)	.535 (13.59)	1.328 (33.73)	1.582 (40.18)	1-3/16-18UNEF
22	1.373 (34.87)	.115 (2.92)	.535 (13.59)	1.578 (40.08)	1.708 (43.38)	1-5/16-18UNEF
24	1.498 (38.05)	.115 (2.92)	.558 (14.43)	1.703 (43.26)	1.832 (46.53)	1-7/16-18UNEF

† Not available in KPSE *(TP) located within .010 T.P. with respect to diameter A and master keyway.

Cable Connecting Plugs with Termination Assemblies

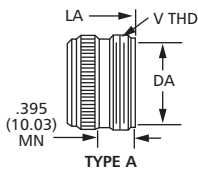

TYPE A

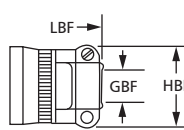

TYPE B AND F

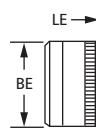

TYPE E

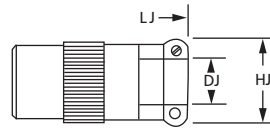

TYPE J

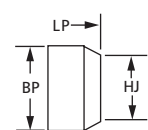

TYPE P

Shell Size	TYPE A			TYPE B and F			TYPE E	
	DA Min.	LA Max.	V Thread Class 2A	GBF Min.	HBF Max.	LBF Max.	BE Max.	LE Max.
†8	.335 (8.51)	1.50 (38.00)	1/2-28UNEF	.115 (2.92)	.828 (21.03)	1.922 (48.82)	.608 (15.44)	1.328 (33.73)
10	.466 (11.84)	1.50 (38.00)	5/8-24UNEF	.178 (4.52)	.891 (22.63)	1.922 (48.82)	.734 (18.64)	1.328 (33.73)
12	.591 (15.01)	1.50 (38.00)	3/4-20UNEF	.302 (7.67)	1.016 (25.81)	1.922 (48.82)	.858 (21.79)	1.328 (33.73)
14	.700 (17.90)	1.50 (38.00)	7/8-20UNEF	.365 (9.27)	1.141 (28.98)	1.922 (48.82)	.984 (24.99)	1.328 (33.73)
16	.830 (21.08)	1.50 (38.00)	1-20UNEF	.490 (12.45)	1.203 (30.56)	2.047 (51.99)	1.110 (28.19)	1.328 (33.73)
18	.948 (24.08)	1.50 (38.00)	1-3/16-18UNEF	.615 (15.62)	1.469 (37.31)	2.078 (52.78)	1.234 (31.34)	1.328 (33.73)
20	1.043 (26.49)	1.728 (43.89)	1-3/16-18UNEF	.615 (15.62)	1.469 (37.31)	2.344 (59.54)	1.360 (34.54)	1.531 (38.89)
22	1.198 (30.43)	1.728 (43.89)	1-7/16-18UNEF	.740 (18.80)	1.656 (42.06)	1.344 (34.14)	1.484 (37.69)	1.531 (38.89)
24	1.293 (32.84)	1.738 (44.15)	1-7/16-18UNEF	.790 (20.07)	1.750 (44.45)	2.406 (61.11)	1.610 (40.49)	1.594 (40.49)

Shell Size	TYPE J		TYPE P	
	DJ Max./Min.	HJ Max.	L J Max.	BP Max.
†8	.230/.168 (5.84/4.27)	.828 (21.03)	2.271 (57.68)	.608 (15.44)
10	.312/.205 (7.92/5.21)	.891 (22.63)	2.271 (57.68)	.734 (18.64)
12	.442/.338 (11.23/8.59)	1.016 (25.81)	2.411 (61.24)	.858 (21.79)
14	.539/.416 (13.56/10.57)	1.141 (28.98)	2.599 (66.01)	.984 (24.99)
16	.616/.550 (15.65/13.97)	1.203 (30.56)	2.943 (74.75)	1.110 (28.19)
18	.672/.600 (17.07/15.24)	1.469 (37.31)	3.172 (80.57)	1.234 (31.34)
20	.747/.634 (18.97/16.13)	1.469 (37.31)	3.610 (91.69)	1.360 (34.54)
22	.846/.670 (21.49/17.02)	1.656 (42.06)	3.766 (95.66)	1.484 (37.69)
24	.894/.740 (22.71/18.80)	1.750 (44.45)	3.985 (101.22)	1.610 (40.89)



Dimensions shown in inches (mm)
Specifications and dimensions subject to change

www.ittcannon.com

Box Mounting Receptacles

MS3112 (MS service class E)
MS3122 (MS service class E)

KPT02
KPSE02

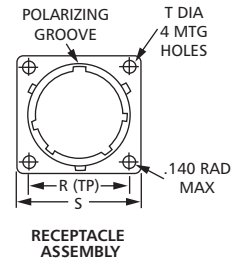
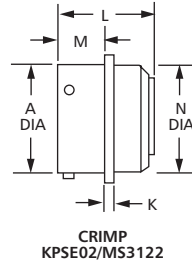
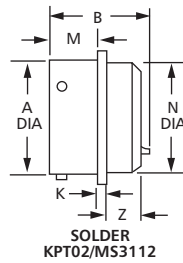

Note: Connector does not accommodate backshell.

Shell Size	A ±.003 (±.08)	B Max.	K ±.016 (±.41)	L Max.	M +.031 (+.79) -.000 (-.00)	N Dia. Max.	R* (TP)	S Max.	T ±.005	Z Max.
†8	.471 (11.96)	.978 (24.84)	.062 (1.57)	1.320 (33.07)	.431 (10.95)	.469 (11.91)	.594 (15.09)	.828 (21.03)	.120 (3.05)	.354 (8.99)
10	.588 (14.96)	.978 (24.84)	.062 (1.57)	1.320 (33.07)	.431 (10.95)	.593 (15.06)	.719 (18.26)	.954 (24.23)	.120 (3.05)	.354 (8.99)
12	.748 (19.00)	.978 (24.84)	.062 (1.57)	1.320 (33.07)	.431 (10.95)	.719 (18.26)	.812 (20.62)	1.047 (26.59)	.120 (3.05)	.354 (8.99)
14	.873 (22.17)	.978 (24.84)	.062 (1.57)	1.320 (33.07)	.431 (10.95)	.843 (21.41)	.906 (23.01)	1.141 (28.98)	.120 (3.05)	.354 (8.99)
16	.998 (25.35)	.978 (24.84)	.062 (1.57)	1.320 (33.07)	.431 (10.95)	.969 (24.61)	.969 (24.61)	1.234 (31.34)	.120 (3.05)	.354 (8.99)
18	1.123 (28.52)	.978 (24.84)	.062 (1.57)	1.320 (33.07)	.431 (10.95)	1.093 (27.76)	1.062 (26.97)	1.328 (33.73)	.120 (3.05)	.354 (8.99)
20	1.248 (31.70)	1.196 (30.38)	.094 (2.39)	1.387 (34.72)	.556 (14.12)	1.219 (30.96)	1.156 (29.36)	1.453 (36.91)	.120 (3.05)	.417 (10.59)
22	1.373 (34.87)	1.196 (30.38)	.094 (2.39)	1.387 (34.72)	.556 (14.12)	1.343 (34.11)	1.250 (31.75)	1.578 (40.08)	.120 (3.05)	.417 (10.59)
24	1.498 (38.05)	1.196 (30.38)	.094 (2.39)	1.418 (36.02)	.589 (14.96)	1.469 (37.31)	1.375 (34.92)	1.703 (43.26)	.147 (3.73)	.445 (11.30)

† Not available in KPSE *(TP) located within .010 T.P. with respect to diameter A and master keyway.



A

Circular



Circular

Straight Plugs

MS3116 (MS service class E,F,J,P)
MS3126 (MS service class E,F,P)

KPT06
KPSE06

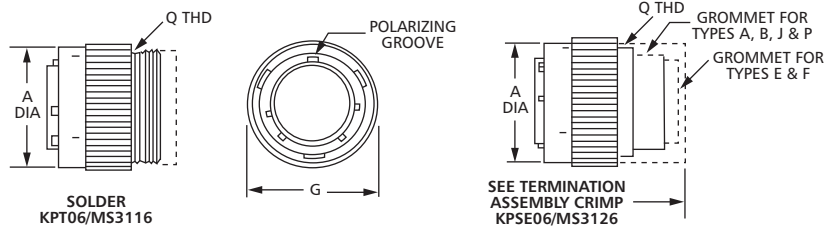

Shell Size	A Dia. Max.	G Max.	J ±.010 (±0.25)	Q Thread Class 2A
†8	.765 (19.43)	.782 (19.86)	.353 (8.99)	7/16-28UNEF
10	.840 (21.34)	.926 (23.52)	.353 (8.99)	9/16-24UNEF
12	.999 (25.38)	1.043 (26.49)	.353 (8.99)	11/16-24UNEF
14	1.139 (28.93)	1.183 (30.05)	.353 (8.99)	13/16-20UNEF
16	1.261 (32.03)	1.305 (33.15)	.353 (8.99)	15/16-20UNEF
18	1.337 (33.96)	1.391 (35.33)	.353 (8.99)	1-1/16-18UNEF
20	1.477 (37.52)	1.531 (38.89)	.415 (10.54)	1-3/16-18UNEF
22	1.602 (40.69)	1.656 (42.06)	.415 (10.54)	1-5/16-18UNEF
24	1.723 (43.76)	1.777 (45.14)	.415 (10.54)	1-7/16-18UNEF

† Not available in KPSE

Straight Plugs with Termination Assemblies

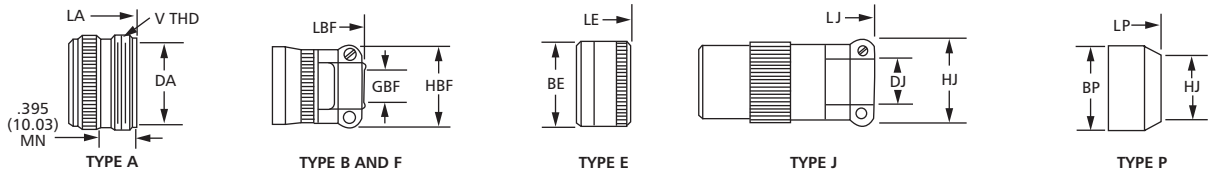

Shell Size	TYPE A			TYPE B and F			TYPE E	
	DA Min.	LA Max.	V Thread Class 2A	GBF Min.	HBF Max.	LBF Max.	BE Max.	LE Max.
†8	.335 (8.51)	1.440 (36.58)	1/2-28UNEF	.115 (2.92)	.828 (21.03)	1.906 (48.41)	.608 (15.44)	1.328 (33.73)
10	.466 (11.84)	1.440 (36.58)	5/8-24UNEF	.178 (4.52)	.891 (22.63)	1.906 (48.41)	.734 (18.64)	1.328 (33.73)
12	.591 (15.01)	1.440 (36.58)	3/4-20UNEF	.302 (7.67)	1.016 (25.81)	1.906 (48.41)	.858 (21.79)	1.328 (33.73)
14	.700 (17.90)	1.440 (36.58)	7/8-20UNEF	.365 (9.27)	1.141 (28.98)	1.906 (48.41)	.984 (24.99)	1.328 (33.73)
16	.830 (21.08)	1.440 (36.58)	1-20UNEF	.490 (12.45)	1.203 (30.56)	2.047 (51.99)	1.110 (28.19)	1.328 (33.73)
18	.948 (24.08)	1.662 (42.21)	1-3/16-18UNEF	.615 (15.62)	1.469 (37.31)	2.078 (52.78)	1.234 (31.34)	1.328 (33.73)
20	1.043 (26.49)	1.662 (42.21)	1-3/16-18UNEF	.615 (15.62)	1.469 (37.31)	2.250 (57.15)	1.360 (34.54)	1.453 (36.91)
22	1.198 (30.43)	1.662 (42.21)	1-7/16-18UNEF	.740 (18.80)	1.656 (42.06)	2.250 (57.15)	1.484 (37.69)	1.453 (36.91)
24	1.293 (32.84)	1.672 (42.47)	1-7/16-18UNEF	.790 (20.07)	1.750 (44.45)	2.312 (58.72)	1.610 (40.49)	1.510 (38.54)

Shell Size	TYPE J			TYPE P		
	DJ Max./Min.	HJ Max.	LJ Max.	BP Max.	DP Min.	LP Max.
†8	.230/.168 (5.84/4.27)	.828 (21.03)	2.271 (57.68)	.608 (15.44)	.317 (8.05)	1.500 (38.10)
10	.312/.205 (7.92/5.21)	.891 (22.63)	2.271 (57.68)	.734 (18.64)	.434 (11.02)	1.500 (38.10)
12	.442/.338 (11.23/8.59)	1.016 (25.81)	2.411 (61.24)	.858 (21.79)	.548 (13.92)	1.500 (38.10)
14	.539/.416 (13.56/10.57)	1.141 (28.98)	2.599 (66.01)	.984 (24.99)	.673 (17.09)	1.500 (38.10)
16	.616/.550 (15.65/13.97)	1.203 (30.56)	2.943 (74.75)	1.110 (28.19)	.798 (20.27)	1.500 (38.10)
18	.672/.600 (17.07/15.24)	1.469 (37.31)	3.172 (80.57)	1.234 (31.34)	.899 (20.83)	1.500 (38.10)
20	.747/.634 (18.97/16.13)	1.469 (37.31)	3.610 (91.69)	1.360 (34.54)	1.024 (26.01)	1.609 (40.87)
22	.846/.670 (21.49/17.02)	1.656 (42.06)	3.766 (95.66)	1.484 (37.69)	1.149 (29.18)	1.609 (40.87)
24	.894/.740 (22.71/18.80)	1.750 (44.45)	3.985 (101.22)	1.610 (40.89)	1.274 (32.36)	1.687 (42.85)

† Not available in KPSE

LA, LBF, LE, LJ and LP are connector overall lengths



Dimensions shown in inches (mm)
Specifications and dimensions subject to change

www.ittcannon.com

Jam Nut Receptacles

MS3114 (MS service class E,F,P)
MS3124 (MS service class E,F,P)

KPT07
KPSE07

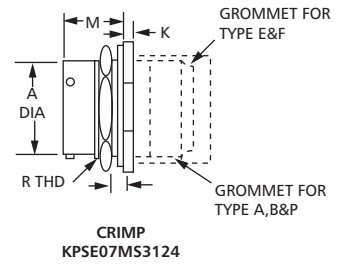
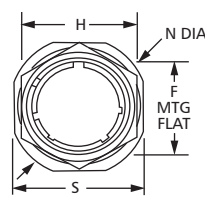
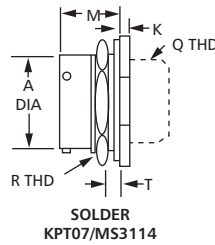

Shell Size	A		H	K	M		S	T		R Thread Class 2A
	$\pm .003 (\pm .08)$	$\pm .005 (0.130)$			$\pm .017 (\pm .43)$	$\pm .020 (\pm .05)$		$+ .031 (+ .08)$ $- .000 (- .00)$	N Max.	
†8	.471 (11.96)	.525 (13.34)	.750 (19.05)	.117 (2.97)	.691 (17.55)	1.078 (27.38)	.954 (15.09)	.062 (1.57)	.125 (3.17)	9/16-24UNEF
10	.588 (14.96)	.650 (16.51)	.875 (22.22)	.117 (2.97)	.691 (17.55)	1.206 (30.56)	1.078 (27.38)	.062 (1.57)	.125 (3.17)	11/16-24UNEF
12	.748 (19.00)	.813 (20.65)	1.062 (26.97)	.117 (2.97)	.691 (17.55)	1.319 (35.33)	1.266 (32.16)	.062 (1.57)	.125 (3.17)	7/8-20UNEF
14	.873 (22.17)	.937 (23.80)	1.188 (30.17)	.117 (2.97)	.691 (17.55)	1.516 (38.51)	1.391 (35.33)	.062 (1.57)	.125 (3.17)	1-20UNEF
16	.998 (25.35)	1.061 (26.95)	1.312 (33.32)	.117 (2.97)	.691 (17.55)	1.641 (41.68)	1.516 (38.51)	.062 (1.57)	.125 (3.17)	1-1/8-18UNEF
18	1.123 (28.52)	1.186 (30.12)	1.438 (36.25)	.117 (2.97)	.691 (17.55)	1.766 (44.86)	1.641 (41.68)	.062 (1.57)	.125 (3.17)	1-1/4-18UNEF
20	1.248 (31.70)	1.311 (33.30)	1.562 (39.67)	.148 (3.76)	.879 (22.33)	1.954 (49.63)	1.828 (46.43)	.062 (1.57)	.250 (6.35)	1-3/8-18UNEF
22	1.373 (34.87)	1.436 (36.47)	1.688 (42.87)	.148 (3.76)	.879 (22.33)	2.078 (52.78)	1.954 (49.63)	.062 (1.57)	.250 (6.35)	1-1/2-18UNEF
24	1.498 (38.05)	1.561 (39.65)	1.812 (46.02)	.148 (3.76)	.912 (23.16)	2.203 (55.96)	2.078 (52.78)	.062 (1.57)	.250 (6.35)	1-5/8-18UNEF

† Not available in KPSE

Jam Nut Receptacles with Termination Assemblies

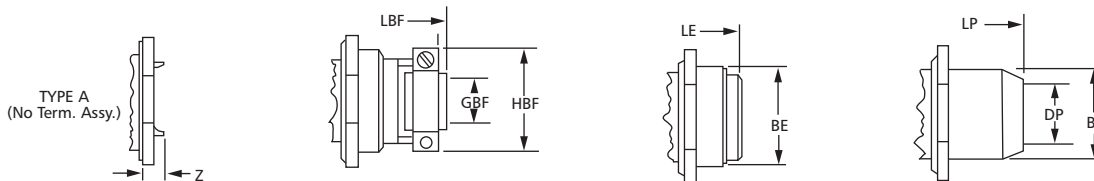

Shell Size	TYPE A	TYPE B and F			TYPE E		TYPE P		
	Z Max.	HBF Max.	GBF Min.	LBF Max.	BE Max.	LE Max.	BP Max.	DP Min.	LP Max.
†8	.312 (7.92)	.828 (21.03)	.115 (2.92)	1.906 (48.41)	.655 (16.64)	1.344 (34.14)	.608 (15.44)	.317 (8.05)	1.391 (35.33)
10	.312 (7.92)	.891 (22.63)	.178 (4.52)	1.906 (48.41)	.843 (21.41)	1.344 (34.14)	.734 (18.64)	.434 (11.02)	1.391 (35.33)
12	.312 (7.92)	1.016 (25.81)	.302 (7.67)	1.906 (48.41)	.968 (24.59)	1.344 (34.14)	.858 (21.79)	.548 (13.92)	1.391 (35.33)
14	.312 (7.92)	1.141 (28.98)	.365 (9.27)	1.906 (48.41)	1.093 (27.76)	1.344 (34.14)	.984 (24.99)	.673 (17.09)	1.391 (35.33)
16	.312 (7.92)	1.203 (30.56)	.490 (12.45)	2.047 (51.99)	1.218 (30.94)	1.344 (34.14)	1.110 (28.19)	.798 (20.27)	1.391 (35.33)
18	.312 (7.92)	1.469 (37.31)	.615 (15.62)	2.078 (52.78)	1.343 (34.11)	1.344 (34.14)	1.234 (31.34)	.899 (22.83)	1.391 (35.33)
20	.193 (4.90)	1.469 (37.31)	.615 (15.62)	2.328 (59.13)	1.500 (38.10)	1.594 (40.49)	1.360 (34.54)	1.024 (26.01)	1.641 (41.68)
22	.193 (4.90)	1.656 (42.06)	.740 (18.80)	2.328 (59.13)	1.625 (41.28)	1.594 (40.49)	1.484 (37.69)	1.149 (29.18)	1.641 (41.68)
24	.150 (3.81)	1.750 (44.45)	.790 (20.07)	2.453 (62.31)	1.750 (44.45)	1.641 (41.68)	1.610 (40.89)	1.274 (32.36)	1.703 (43.26)

LBF, LE, and LP are connector overall lengths.



A

Circular

Right Angle Plugs

KPT08/KPSE08

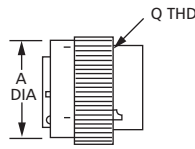

KPT08

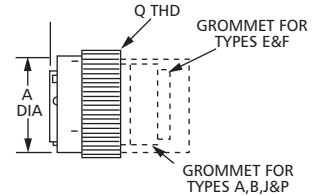
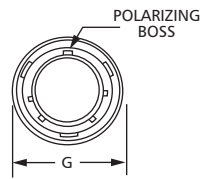

KPSE08

Shell Size	KPT/KPSE		Q Thread Class 2A
	A Dia. Max.	G Max.	
†8	.765 (19.43)	.782 (19.86)	7/16-28UNEF
10	.866 (22.00)	.926 (23.52)	9/16-24UNEF
12	1.031 (26.20)	1.043 (26.49)	11/16-24UNEF
14	1.157 (29.40)	1.183 (30.05)	13/16-20UNEF
16	1.291 (32.80)	1.305 (33.15)	15/16-20UNEF
18	1.394 (35.40)	1.391 (35.33)	1-1/16-18UNEF
20	1.535 (39.00)	1.531 (38.89)	1-3/16-18UNEF
22	1.657 (42.10)	1.656 (42.06)	1-5/16-18UNEF
24	1.780 (45.20)	1.777 (45.14)	1-7/16-18UNEF

† Not available in KPSE

NOTE: for size 10 and 24 consult factory for availability in type A,B,E and F.
For size 8 consult factory for availability in Type P.

Right Angle Plugs with Termination Assemblies

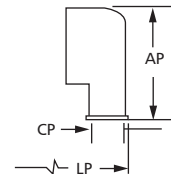
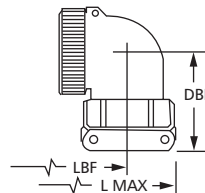
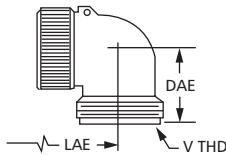

Shell Size	LAE	TYPE A and E		V Thread Max.	DBF Class 2A	TYPE B and F		L Max.	AP Max.	TYPE P	
		DAE Max.	V Thread Max.			LBF Max.	L Max.			LP Max.	CP Min.
Max.											
†8	1.421 (36.09)	.822 (20.88)	1/2-28UNEF	1.238 (31.44)	1.421 (36.09)	1.842 (46.79)	-(-)	-(-)	-(-)		
10	1.484 (37.69)	.853 (21.67)	5/8-28UNEF	1.269 (32.24)	1.484 (37.69)	1.937 (49.20)	1.030 (26.16)	1.380 (35.05)	.252 (6.40)		
12	1.546 (39.27)	.916 (23.27)	3/4-20UNEF	1.395 (35.43)	1.546 (39.27)	2.091 (53.10)	1.030 (26.16)	1.567 (39.80)	.252 (6.40)		
14	1.577 (40.05)	.978 (24.84)	7/8-20UNEF	1.519 (38.58)	1.577 (40.05)	2.173 (55.20)	1.030 (26.16)	1.567 (39.80)	.283 (7.19)		
16	1.609 (40.87)	1.041 (26.44)	1-20UNEF	1.582 (40.18)	1.609 (40.87)	2.238 (56.85)	1.280 (32.51)	1.567 (39.80)	.355 (9.02)		
18	1.734 (44.04)	1.103 (28.70)	1-3/16-18UNEF	1.644 (41.76)	1.734 (44.04)	2.455 (62.35)	1.280 (32.51)	1.755 (44.58)	.530 (13.46)		
20	1.879 (47.73)	1.166 (29.62)	1-3/16-18UNEF	1.707 (43.36)	1.879 (47.73)	2.629 (66.78)	1.530 (38.86)	1.782 (45.26)	.562 (14.27)		
22	2.035 (51.69)	1.245 (31.62)	1-7/16-18UNEF	1.884 (47.85)	2.035 (51.69)	2.815 (71.51)	1.530 (38.86)	1.782 (45.26)	.562 (14.27)		
24	2.035 (51.69)	1.322 (33.58)	1-7/16-18UNEF	1.963 (49.86)	2.035 (51.69)	2.902 (73.70)	1.780 (45.21)	2.087 (53.01)	.610 (15.49)		

† Not available in KPSE.

NOTE: For size 10 and 24 consult factory for availability in type A,B,E and F. For size 8 consult factory for availability in Type P.





A

Circular

KPSE High performance crimp contact connectors

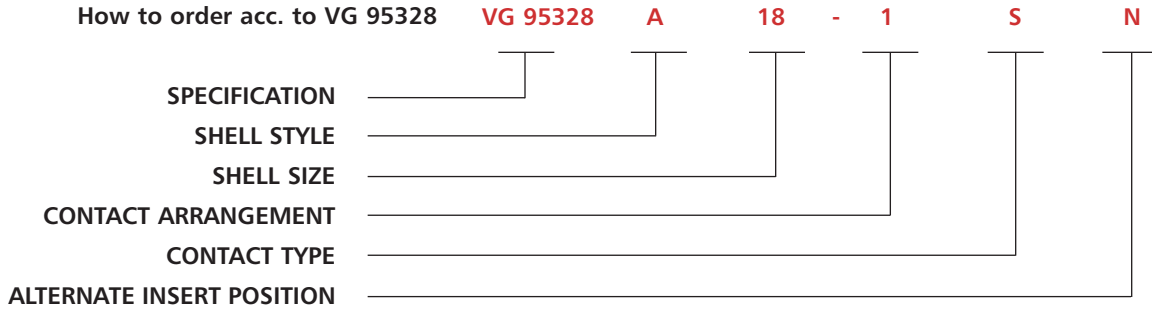

SPECIFICATION

SHELL STYLE

- A -wall mounting receptacle with straight endbell
- B -wall mounting receptacle with cable clamp
- C -box mounting receptacle
- D -jam nut receptacle
- E -jam nut receptacle with cable clamp
- J -straight plug with adapter DN
- K -straight plug with cable clamp
- M -straight plug, version DZ
- N -straight plug
- S -jam nut receptacle with adapter DN
- T -jam nut receptacle, version DZ

SHELL SIZES

8, 10, 12, 14, 16, 18, 20, 22, and 24

CONTACT ARRANGEMENTS

see page A-41

CONTACT TYPE

- P -Pin
- S -Socket

ALTERNATE INSERT POSITION

see page A-42

How to Order – KPTB Thru-Bulkhead Receptacle Connectors

- General Purpose
- Double ended pin and socket contacts
- Contains KPT socket insert
- Nonremovable contacts

KPTB connectors are a series of general purpose, miniature circular connectors, qualified for use in military applications. They are also widely used in industrial applications. The KPTB in a thru-bulkhead version with double faced pin and socket insert construction allowing mating from both ends. They contain

KPT socket inserts with feed-thru (pin/socket) non-removable contacts. The thru-bulkhead receptacle is provided for applications requiring the disconnection of a power source from either side of a panel. A typical connector to be used if air leakage requirements are critical.

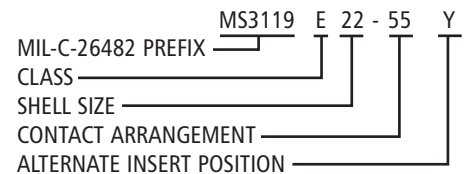
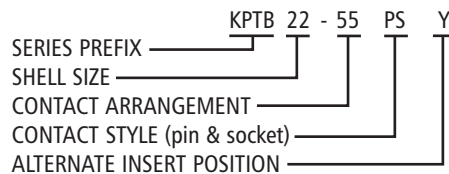

MS3119 (MS service class E)
KPTB (MS service class E)

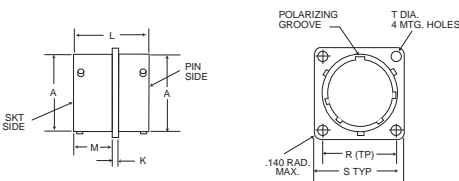

*(T.P.) located within .010 T.P. with respect to the diameter A and master keyway.

Shell Size	A Dia.	K	L	M		S	T
				+ .031 (+.79)	R* (TP)		
8	.471 (11.96)	.062 (1.57)	1.125 (28.58)	.562 (14.27)	.594 (15.09)	7/16-28UNEF	.120 (3.05)
10	.588 (14.94)	.062 (1.57)	1.125 (28.58)	.562 (14.27)	.719 (18.26)	9/16-24UNEF	.120 (3.05)
12	.748 (19.00)	.062 (1.57)	1.125 (28.58)	.562 (14.27)	.812 (20.62)	11/16-24UNEF	.120 (3.05)
14	.873 (22.17)	.062 (1.57)	1.125 (28.58)	.562 (14.27)	.906 (23.01)	13/16-20UNEF	.120 (3.05)
16	.998 (25.35)	.062 (1.57)	1.125 (28.58)	.562 (14.27)	.969 (24.61)	15/16-20UNEF	.120 (3.05)
18	1.123 (28.52)	.062 (1.57)	1.125 (28.58)	.562 (14.27)	1.062 (26.97)	1-1/16-18UNEF	.120 (3.05)
20	1.248 (31.70)	.094 (2.39)	1.406 (35.71)	.688 (17.48)	1.156 (29.36)	1-3/16-18UNEF	.120 (3.05)
22	1.373 (34.87)	.094 (2.39)	1.406 (35.71)	.688 (17.48)	1.250 (31.76)	1-5/16-18UNEF	.120 (3.05)
24	1.498 (38.05)	.094 (2.39)	1.406 (35.71)	.688 (17.48)	1.375 (34.92)	1-7/16-18UNEF	.147 (3.73)

Dimensions shown in inches (mm)
Specifications and dimensions subject to change



Cannon KPT/KPSE MIL-C-26482 Series I Connectors

Circular

Dummy Receptacles

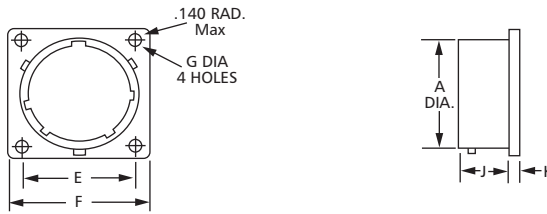
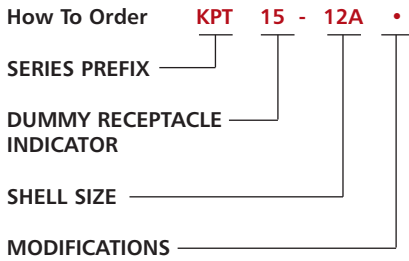

NOTE: For MS Version and additional finishes see PV catalog

SERIES PREFIX
KPT - ITT Cannon Prefix

SHELL SIZE
8 THRU 24

MODIFICATIONS
None-Olive drab chromate over cadmium

Shell Size	A ±.003 (.08)	E Basic	F Max.	G ±.005 (.13)	J +.031 (.79) -.000 (.00)	K ±.016 (.41)
8	.471 (11.96)	.594 (15.09)	.828 (21.03)	.120 (3.05)	.462 (11.73)	.062 (1.57)
10	.588 (14.94)	.719 (18.26)	.954 (24.23)	.120 (3.05)	.462 (11.73)	.062 (1.57)
12	.748 (19.00)	.812 (20.62)	1.047 (26.60)	.120 (3.05)	.462 (11.73)	.062 (1.57)
14	.873 (22.17)	.906 (23.01)	1.141 (28.98)	.120 (3.05)	.462 (11.73)	.062 (1.57)
16	.998 (25.35)	.969 (24.61)	1.234 (31.34)	.120 (3.05)	.462 (11.73)	.062 (1.57)
18	1.123 (28.52)	1.061 (26.97)	1.328 (33.73)	.120 (3.05)	.462 (11.73)	.062 (1.57)
20	1.248 (31.70)	1.156 (29.36)	1.453 (36.91)	.120 (3.05)	.556 (14.12)	.094 (2.39)
22	1.373 (34.87)	1.250 (31.75)	1.578 (40.08)	.120 (3.05)	.556 (14.12)	.094 (2.39)
24	1.498 (38.05)	1.375 (34.93)	1.703 (43.26)	.147 (3.73)	.589 (14.96)	.094 (2.39)

Protective Caps

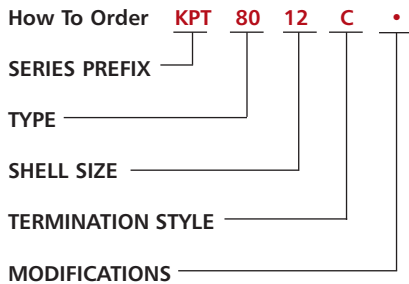

80 - Cap for plugs

81 - Cap for receptacle

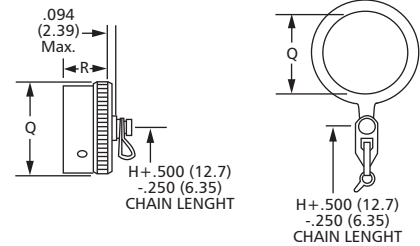
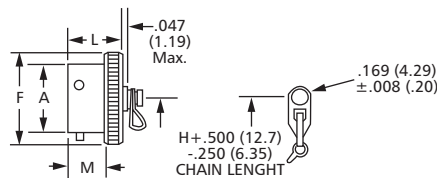

SERIES PREFIX
KPT - ITT Cannon Prefix

TYPE
80 - Plug Cap
81 - Receptacle Cap

SHELL SIZE
8 THRU 24

TERMINATION STYLE
C - Sash Chain
N - Sash Chain with Ring

NOTE: F or MS version and additional finishes see PV catalog.

Shell Size	A ±.003 (.08)	F Max.	H	L Max.	M +.031 (.79) -.000 (.00)	N Min.	Q Max.	R Max
8	.471 (11.96)	.719 (18.26)	3.000 (76.20)	.562 (14.27)	.368 (9.35)	.578 (14.68)	.734 (18.64)	.562 (14.27)
10	.588 (14.94)	.844 (21.44)	3.000 (76.20)	.562 (14.27)	.368 (9.35)	.703 (17.86)	.859 (21.82)	.562 (14.27)
12	.748 (19.00)	1.000 (25.40)	3.500 (88.90)	.562 (14.27)	.368 (9.35)	.891 (22.63)	1.000 (25.40)	.562 (14.27)
14	.873 (22.17)	1.125 (28.58)	3.500 (88.90)	.562 (14.27)	.368 (9.35)	1.016 (25.81)	1.025 (28.58)	.562 (14.27)
16	.998 (25.35)	1.250 (31.75)	3.500 (88.90)	.562 (14.27)	.368 (9.35)	1.141 (28.98)	1.250 (31.75)	.562 (14.27)
18	1.123 (28.52)	1.375 (34.93)	3.500 (88.90)	.562 (14.27)	.368 (9.35)	1.266 (32.16)	1.375 (34.93)	.562 (14.27)
20	1.248 (31.70)	1.500 (38.10)	4.000 (101.60)	.625 (15.88)	.430 (10.92)	1.391 (35.33)	1.500 (38.10)	.562 (14.27)
22	1.373 (34.87)	1.625 (41.26)	4.000 (101.60)	.625 (15.88)	.430 (10.92)	1.516 (38.51)	1.625 (41.26)	.562 (14.27)
24	1.498 (38.05)	1.750 (44.45)	4.000 (101.60)	.658 (16.71)	.463 (11.76)	1.641 (41.68)	1.750 (44.45)	.602 (15.29)

MATERIALS and FINISHES

	KPT
Protective Cap	aluminum alloy, olive drab finish per QQ-P-416
Sash Chain	stainless steel
Ring/Rivet	stainless steel
Gasket	polychloroprene



Dimensions shown in inches (mm)
Specifications and dimensions subject to change

www.ittcannon.com



A

Circular

Receptacles with Printed Circuit Board Contacts

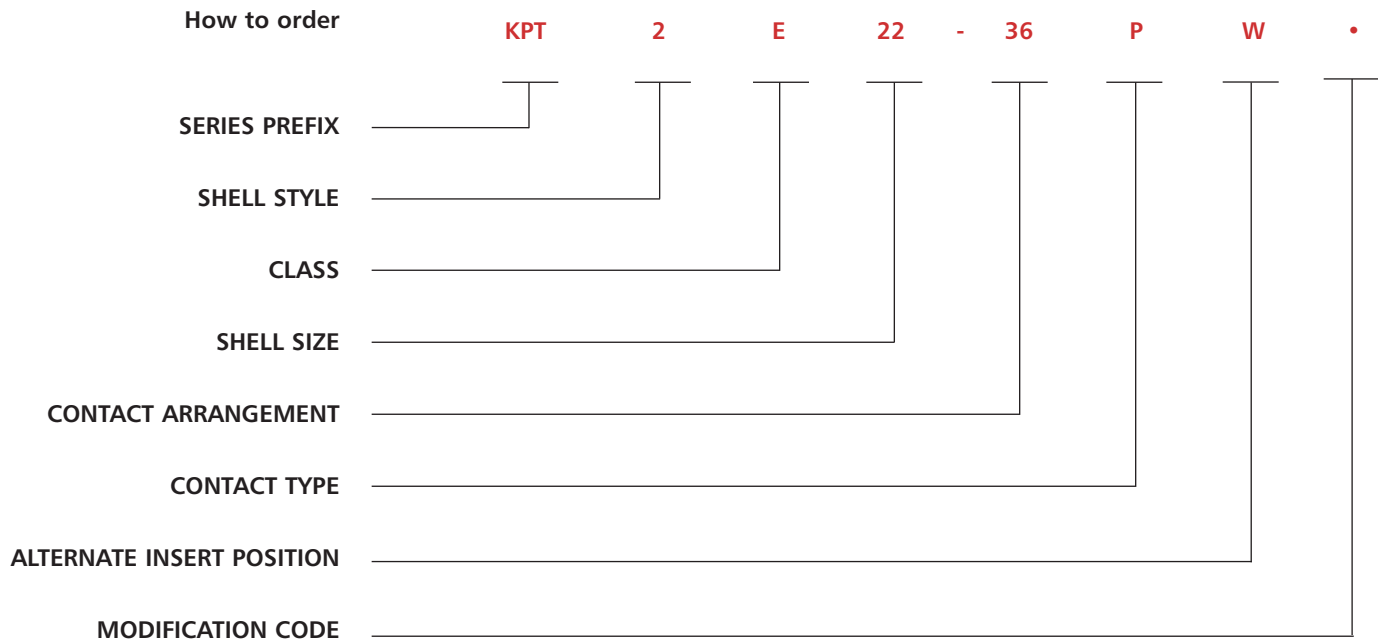

SERIES PREFIX

KPT -ITT Cannon designation

SHELL STYLE

ITT Cannon designation
2 -box mounting receptacle (class E only)
7 -jam nut receptacle

CLASS

A -general duty (shell type 7 only)
E - shell type 2 only

SHELL SIZES

8, 10, 12, 14, 16, 18, 20, 22, and 24

Note: Consult factory for custom PC Tail configurations

CONTACT ARRANGEMENTS

see page A-41

CONTACT TYPE

P -Pin
S -Socket

ALTERNATE INSERT POSITION

W, X, and Z (omit for normal position)

MODIFICATION CODE (see following page for description)

DV - KPT2 with PC tail contacts
.025 ± .001 dia. size 20
.040 ± .001 dia. size 16
EX - KPT2/ KPT7 with PC tail contacts
.76 mm dia. size 16 and size 20
EW - KPT2/ KPT7 with PC tail contacts
.6mm dia. size 16 and size 20

Cannon KPT/KPSE MIL-C-26482 Series I Connectors



A

Circular

KPT Connectors with P.C. Tail Contacts



KPT2E-PDV

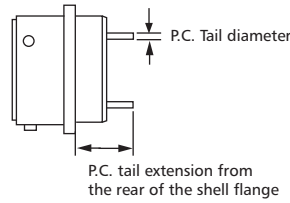

P.C. contacts to extend .600" ± .032" from rear of shell flange.

Contact Size

20	.025 ±.001 Diameter
16	.040 ±.001 Diameter

Contact factory for additional requirements.

Box Mounting Receptacle – KPT2 EW/EX

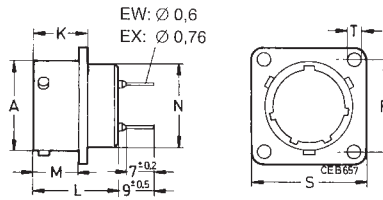

Shell Size	A	K	L	M	N	R	S	Ø T
	+0,03 -0,13	+0,25	max.	±0,15	max.	±0,15	max.	±0,15
8	12,00	13,50	21,1	11,60	11,10	15,10	21,00	3,05
10	15,00	13,50	21,1	11,60	14,30	18,30	24,20	3,05
12	19,05	13,50	21,1	11,60	17,50	20,60	26,60	3,05
14	22,23	13,50	21,1	11,60	20,60	23,00	29,00	3,05
16	25,40	13,50	21,1	11,60	23,80	24,60	31,30	3,05
18	28,58	13,50	21,1	11,60	27,00	27,00	33,70	3,05
20	31,75	16,50	22,7	14,25	30,20	29,40	36,90	3,05
22	34,93	16,50	22,7	14,25	33,40	31,70	40,10	3,05
24	38,10	17,30	22,7	15,10	36,50	34,90	43,30	3,75

Jam Nut Receptacle – KPT7 EW/EX

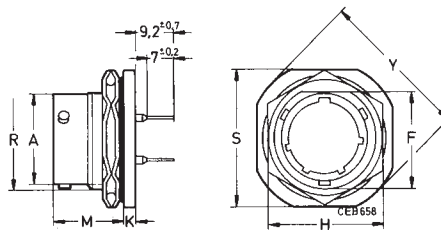

Shell Size*	A	F	H	K	M	R	S	Panel Thickness	Y
	+0,03 -0,13	+0,15	±0,15	±0,25	±0,15	Thread Type 2 A	±0,5	min.	max.
8	12,00	13,3	19,0	3,2	17,7	9/16-24UNEF	2,40	1,6	28,0
10	15,00	16,5	22,2	3,2	17,7	11/16-24UNEF	2,70	1,6	31,0
12	19,05	20,6	27,0	3,2	17,7	7/8-20UNEF	3,20	1,6	36,0
14	22,23	23,8	30,2	3,2	17,7	1-20UNEF	3,50	1,6	39,0
16	25,40	26,9	33,3	3,2	17,7	1-1/8-18UNEF	3,85	1,6	42,0
18	28,58	30,1	36,5	3,2	17,7	1-1/4-18UNEF	4,15	1,6	45,0
20	31,75	33,3	39,7	4,0	22,5	1-3/8-18UNEF	4,60	1,6	50,0
22	34,93	36,5	42,9	4,0	22,5	1-1/2-18UNEF	4,95	1,6	55,0
24	38,10	39,6	46,0	4,0	23,3	1-5/8-18UNEF	5,25	1,6	57,0



Dimensions shown in inches (mm)
Specifications and dimensions subject to change

www.ittcannon.com



A

Circular

Special Versions with Grounding Continuity

These connectors are designed for ensuring continuity.

- At the cable shielding level (to protect it against radio frequency interferences)
- At the grounding level (if it is connected to the shielding)

The plugs are manufactured with grounding fingers soldered to the front face of the shell. They make contact with the inner side of the receptacle shell.

Plug and receptacle feature a special endbell which supports the cable shielding. The connectors are in accordance with the VG 95328 specification.

Receptacle with Grounding Continuity (for shielded cable)

KPT/KPSE 0E...DZ

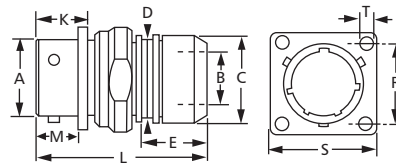

Shell Size	A +.003-0.13	B Min.	C +0.5	D Max.	E 1.00	K ±0.25	L Max.	M ±0.15	R ±0.15	S Max.	øT ±0.15
†8	.472 (12.00)	.360 (6.6)	.630 (16.0)	.524 (13.3)	.590 (15.0)	.531 (13.5)	2.047 (52.0)	.457 (11.6)	.594 (15.1)	.827 (21.0)	.120 (3.05)
10	.590 (15.00)	.362 (9.2)	.709 (18.0)	.634 (16.1)	.590 (15.0)	.531 (13.5)	2.047 (52.0)	.457 (11.6)	.720 (18.3)	.953 (24.2)	.120 (3.05)
12	.750 (19.05)	.480 (12.2)	.866 (22.0)	.787 (20.0)	.669 (17.0)	.531 (13.5)	2.440 (62.0)	.457 (11.6)	.811 (20.6)	1.047 (26.6)	.120 (3.05)
14	.875 (22.23)	.598 (15.2)	.984 (25.0)	.874 (22.2)	.709 (18.0)	.531 (13.5)	2.440 (62.0)	.457 (11.6)	.905 (23.0)	1.142 (29.0)	.120 (3.05)
16	1.00 (25.40)	.720 (18.3)	1.102 (28.0)	1.031 (26.2)	.709 (18.0)	.531 (13.5)	2.440 (62.0)	.457 (11.6)	.968 (24.6)	1.232 (31.3)	.120 (3.05)
18	1.125 (28.58)	.787 (20.0)	1.259 (32.0)	1.122 (28.5)	.709 (18.0)	.531 (13.5)	2.440 (62.0)	.457 (11.6)	1.063 (27.0)	1.327 (33.7)	.120 (3.05)
20	1.25 (31.75)	.905 (23.0)	1.338 (34.0)	1.280 (32.5)	.709 (18.0)	.650 (16.5)	2.440 (62.0)	.561 (14.25)	1.157 (29.4)	1.453 (36.9)	.120 (3.05)
22	1.375 (34.93)	1.023 (26.0)	1.50 (38.0)	1.370 (34.8)	.709 (18.0)	.650 (16.5)	2.440 (62.0)	.561 (14.25)	1.248 (31.7)	1.579 (40.1)	.120 (3.05)
24	1.50 (38.10)	1.134 (28.8)	1.614 (41.0)	1.492 (37.9)	.709 (18.0)	.681 (17.3)	2.440 (62.0)	.594 (15.1)	1.374 (34.9)	1.705 (43.3)	.148 (3.75)

† In series KPSE only contact arrangements 8-3A and 8-33 available

Dimensions shown in inches (mm)
Specifications and dimensions subject to change

www.ittcannon.com

Cannon KPT/KPSE MIL-C-26482 Series I Connectors



A

Circular

Cable Connecting Plug with Grounding Continuity (for shielding cable)

KPT/KPSE 1E...DZ

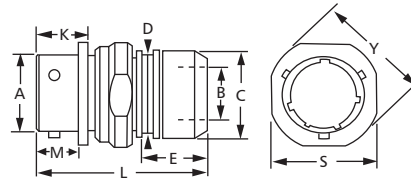

Shell Size	A +.003-0.13	B Min.	C +0.50	D Max.	E ±1.0	K ±0.25	L Max.	M ±0.15	S Max.	øY Max.
†8	.472 (12.00)	.360 (6.6)	.630 (16.0)	.524 (13.3)	.590 (15.0)	.531 (13.5)	2.047 (52.0)	.457 (11.6)	.728 (18.5)	.827 (21.0)
10	.590 (15.00)	.362 (9.2)	.709 (18.0)	.634 (16.1)	.590 (15.0)	.531 (13.5)	2.047 (52.0)	.457 (11.6)	.905 (23.0)	.953 (24.2)
12	.750 (19.05)	.480 (12.2)	.866 (22.0)	.787 (20.0)	.669 (17.0)	.531 (13.5)	2.440 (62.0)	.457 (11.6)	1.142 (29.0)	1.047 (26.6)
14	.875 (22.23)	.598 (15.2)	.984 (25.0)	.874 (22.2)	.709 (18.0)	.531 (13.5)	2.440 (62.0)	.457 (11.6)	1.161 (29.5)	1.142 (29.0)
16	1.00 (25.40)	.720 (18.3)	1.102 (28.0)	1.031 (26.2)	.709 (18.0)	.531 (13.5)	2.440 (62.0)	.457 (11.6)	1.126 (32.0)	1.232 (31.3)
18	1.125 (28.58)	.787 (20.0)	1.259 (32.0)	1.122 (28.5)	.709 (18.0)	.531 (13.5)	2.440 (62.0)	.457 (11.6)	1.378 (35.0)	1.327 (33.7)
20	1.25 (31.75)	.905 (23.0)	1.338 (34.0)	1.280 (32.5)	.709 (18.0)	.650 (16.5)	2.440 (62.0)	.561 (14.25)	1.516 (38.5)	1.453 (36.9)
22	1.375 (34.93)	1.023 (26.0)	1.50 (38.0)	1.370 (34.8)	.709 (18.0)	.650 (16.5)	2.440 (62.0)	.561 (14.25)	1.653 (42.0)	1.579 (40.1)
24	1.50 (38.10)	1.134 (28.8)	1.614 (41.0)	1.492 (37.9)	.709 (18.0)	.681 (17.3)	2.440 (62.0)	.594 (15.1)	1.811 (46.0)	1.705 (43.3)

† In series KPSE only contact arrangements 8-3A and 8-33 available

Straight Plug with Grounding Continuity

KPT/KPSE 6E...DZ

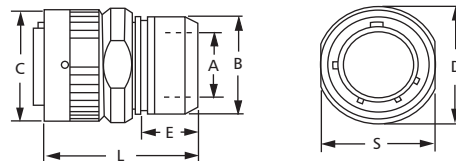

Shell Size	A Min.	B +0.50	C Max.	D Max.	E ±1.0	L Max.	S ±0.2
†8	.360 (6.6)	.630 (16.0)	.752 (19.1)	(20.0)	.590 (15.0)	1.890 (48.0)	.669 (17.0)
10	.362 (9.2)	.709 (18.0)	.866 (22.0)	(15.0)	.590 (15.0)	1.890 (48.0)	.748 (19.0)
12	.480 (12.2)	.866 (22.0)	1.031 (26.2)	(26.0)	.669 (17.0)	1.890 (48.0)	.905 (23.0)
14	.598 (15.2)	.984 (25.0)	1.157 (29.4)	(30.0)	.709 (18.0)	1.929 (49.0)	1.024 (26.0)
16	.720 (18.3)	1.102 (28.0)	1.291 (32.8)	(33.0)	.709 (18.0)	1.929 (49.0)	1.142 (29.0)
18	.787 (20.0)	1.260 (32.0)	1.394 (35.4)	(36.0)	.709 (18.0)	1.929 (49.0)	1.299 (33.0)
20	.905 (23.0)	1.340 (34.0)	1.535 (39.0)	(40.0)	.709 (18.0)	2.087 (53.0)	1.378 (35.0)
22	1.023 (26.0)	1.50 (38.0)	1.657 (42.1)	(43.0)	.709 (18.0)	2.087 (53.0)	1.535 (39.0)
24	1.133 (28.8)	1.614 (41.0)	1.779 (45.2)	(46.0)	.709 (18.0)	2.087 (53.0)	1.653 (42.0)

† In series KPSE only contact arrangements 8-3A and 8-33 available



Dimensions shown in inches (mm)
Specifications and dimensions subject to change

www.ittcannon.com



A

Circular

Jam Nut Receptacle with Grounding Continuity (for shielded cable)

KPT/KPSE 7E...DZ

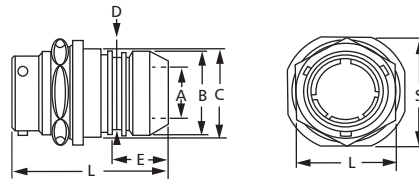

Shell Size	øA Min.	øB +0.5	øC Max.	D Max.	E 1.0	L Max.	S ±0.25	T ±0.25
†8	.360 (6.6)	.630 (16.0)	.716 (18.2)	.524 (13.3)	.590 (15.0)	1.850 (47.0)	.905 (23.0)	.748 (19.0)
10	.362 (9.2)	.709 (18.0)	.842 (21.4)	.634 (16.1)	.590 (15.0)	1.850 (47.0)	1.063 (27.0)	.874 (22.2)
12	.480 (12.2)	.866 (22.0)	.968 (24.6)	.787 (20.0)	.669 (17.0)	1.929 (49.0)	1.248 (31.7)	1.063 (27.0)
14	.598 (15.2)	.984 (25.0)	1.094 (27.8)	.874 (22.2)	.709 (18.0)	1.968 (50.0)	1.374 (34.9)	1.089 (30.2)
16	.720 (18.3)	1.102 (28.0)	1.216 (30.9)	1.031 (26.2)	.709 (18.0)	1.968 (50.0)	1.50 (38.1)	1.311 (33.3)
18	.787 (20.0)	1.260 (32.0)	1.342 (34.1)	1.222 (28.5)	.709 (18.0)	1.968 (50.0)	1.626 (41.3)	1.437 (36.5)
20	.905 (23.0)	1.340 (34.0)	1.50 (38.1)	1.279 (32.5)	.709 (18.0)	2.165 (55.0)	1.811 (46.0)	1.563 (39.7)
22	1.023 (26.0)	1.50 (38.0)	1.626 (41.3)	1.370 (34.8)	.709 (18.0)	2.165 (55.0)	1.937 (49.2)	1.689 (42.9)
24	1.133 (28.8)	1.614 (41.0)	1.748 (44.4)	1.492 (37.9)	.709 (18.0)	2.165 (55.0)	2.059 (52.3)	1.811 (46.0)

† In series KPSE only contact arrangements 8-3A and 8-33 available

Wiring Instructions

KPT/KPSE ...DZ

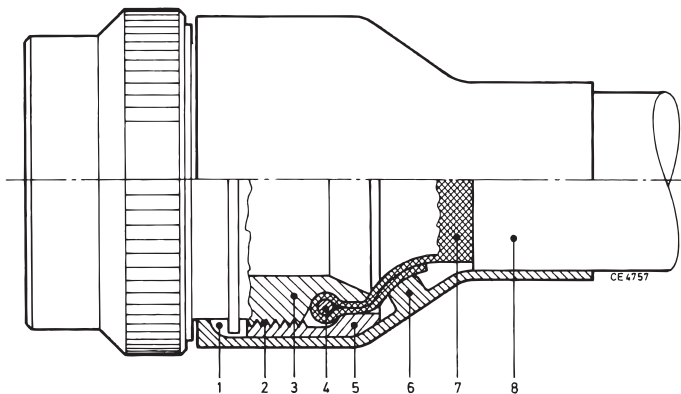

Fixing of shielding braid to connectors with DZ-adapter

- Loosen lock nut (5). Slide heat shrink component (6) and lock nut (5) over cable.
- Push shielding braid (7) onto endbell (3) and over thread (2).
- Fasten shielding braid (7) into rounded groove by means of bailing wire
- Fold back protruding shielding braid on cone.
- Slide lock nut (5) onto endbell (3). The folded back shielding braid protrudes under the tightened lock nut.
- Shrink heat shrink component (6) according to manufacturer's instructions. (End of heat shrink component to be located in square groove (1)).

Dimensions shown in inches (mm)
Specifications and dimensions subject to change

www.ittcannon.com





Circular

A

Box and Wall Mounting Receptacle

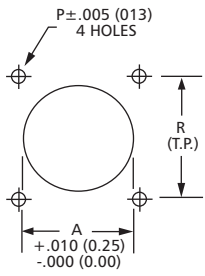

Jam Nut Receptacle

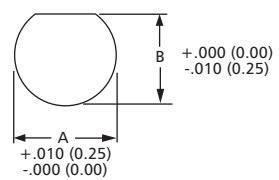

Shell Size	FLANGE (FRONT MOUNTING) KPT/KPSE		MOUNTING HOLE DIA.	
	A Dia.	R	KPT/KPSE P ± .005	Screw
†8	.618 (15.70)	.594 (15.09)	.125 (3.17)	#4
10	.735 (16.67)	.719 (18.26)	.125 (3.17)	#4
12	.859 (21.82)	.812 (20.62)	.125 (3.17)	#4
14	.985 (25.02)	.906 (23.01)	.125 (3.17)	#4
16	1.113 (28.27)	.969 (24.61)	.125 (3.17)	#4
18	1.235 (31.37)	1.062 (26.97)	.125 (3.17)	#4
20	1.361 (34.57)	1.156 (29.36)	.125 (3.17)	#4
22	1.485 (37.72)	1.250 (31.75)	.125 (3.17)	#4
24	1.611 (40.92)	1.375 (34.92)	.155 (3.94)	#6

† Not available in KPSE connectors.

Shell Size	A	KPT/KPSE B
†8	.578 (14.68)	.540 (13.72)
10	.703 (17.86)	.665 (16.89)
12	.890 (22.61)	.828 (21.02)
14	1.015 (25.78)	.952 (24.18)
16	1.140 (28.96)	1.076 (27.33)
18	1.265 (32.13)	1.201 (30.51)
20	1.390 (35.31)	1.326 (33.68)
22	1.515 (38.48)	1.451 (36.86)
24	1.640 (41.66)	1.576 (40.03)

† Not available in KPSE connectors.

Panel Thickness

Maximum panel thickness dimensions allowable to ensure complete connector operation for the the Wall Mounting Receptacle, Box Mounting Receptacle, and Thru-Bulkhead Receptacle.

Wall Mounting and Box Mounting Receptacle

Thru-Bulkhead Receptacle

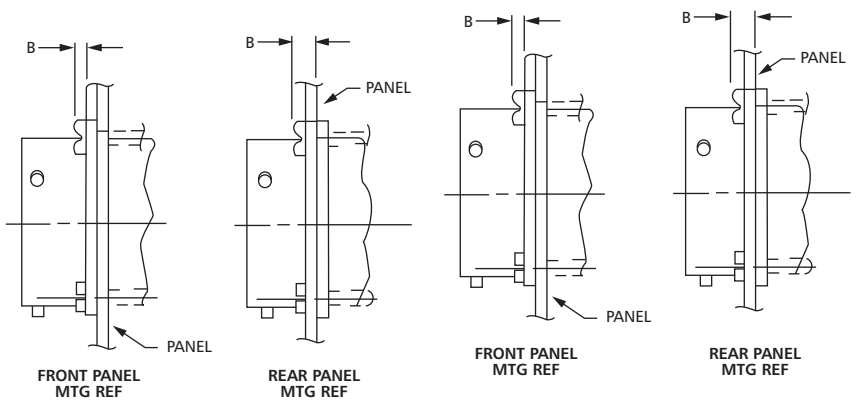

Size	B Max.
8	.087 (2.21)
10	
12	
14	
16	
18	.212 (5.38)
20	
22	
24	

Size	B Max. panel and screw head
8	.218 (5.54)
10	
12	
14	.334 (8.74)
16	
18	.311 (7.90)
20	
22	
24	



Dimensions shown in inches (mm)
Specifications and dimensions subject to change



A

Circular

MIL-C-26482 Specifications

The following excerpts are some of the parameter requirements of the MIL-C-26482 specification.

Test Description	Paragraph Reference	Requirements																																										
Contact Retention	4.6.32.1	After preloading to 3 pounds maximum, the force shall be applied at a rate of approximately 1 pound per second and maintained at full load for 5-10 seconds.. No damage to contacts or insert shall result nor shall the contacts be dislocated from their normal position in the connector more than 0.012 inch under giveload for KPSE and within 1 minute after the load is removed for KPT.																																										
		<table border="1"> <tr> <td>Contact Size</td> <td>20</td> <td>16</td> <td>12</td> </tr> <tr> <td>Load in Pounds Min.</td> <td>15</td> <td>25</td> <td>25</td> </tr> <tr> <td>Load in KG Min.</td> <td>6.8</td> <td>11.3</td> <td>11.3</td> </tr> </table>	Contact Size	20	16	12	Load in Pounds Min.	15	25	25	Load in KG Min.	6.8	11.3	11.3																														
		Contact Size	20	16	12																																							
Load in Pounds Min.	15	25	25																																									
Load in KG Min.	6.8	11.3	11.3																																									
Contact Insertion/Extraction (KPSE only) Coupling Torque	4.6.11	When using the proper insertion and extraction tools the forces required to insert or extract the contact shall not exceed 20 Lbs. Connectors shall be less endbell.																																										
	4.6.3	For qualification testing, mating halves shall be coupled and uncoupled, measuring the torques necessary. The torques required to couple and uncouple mating connectors halves shall fall within the limits specified as follows:																																										
		<table border="1"> <thead> <tr> <th colspan="3">Torque in lb (NM)</th> <th colspan="3">Torque in lb. (NM)</th> </tr> <tr> <th>Shell Size</th> <th>Max</th> <th>Min.</th> <th>Shell Size</th> <th>Max</th> <th>Min</th> </tr> </thead> <tbody> <tr> <td>8</td> <td>8 (.90)</td> <td>1 (.11)</td> <td>18</td> <td>28 (3.16)</td> <td>4 (.45)</td> </tr> <tr> <td>10</td> <td>12 (1.36)</td> <td>1 (.11)</td> <td>20</td> <td>32 (3.62)</td> <td>6 (.68)</td> </tr> <tr> <td>12</td> <td>16 (1.81)</td> <td>2 (.23)</td> <td>22</td> <td>36 (4.07)</td> <td>7 (.79)</td> </tr> <tr> <td>14</td> <td>20 (2.26)</td> <td>4 (.45)</td> <td>24</td> <td>44 (4.97)</td> <td>7 (.79)</td> </tr> <tr> <td>16</td> <td>24 (2.71)</td> <td>4 (.45)</td> <td></td> <td></td> <td></td> </tr> </tbody> </table>	Torque in lb (NM)			Torque in lb. (NM)			Shell Size	Max	Min.	Shell Size	Max	Min	8	8 (.90)	1 (.11)	18	28 (3.16)	4 (.45)	10	12 (1.36)	1 (.11)	20	32 (3.62)	6 (.68)	12	16 (1.81)	2 (.23)	22	36 (4.07)	7 (.79)	14	20 (2.26)	4 (.45)	24	44 (4.97)	7 (.79)	16	24 (2.71)	4 (.45)			
Torque in lb (NM)			Torque in lb. (NM)																																									
Shell Size	Max	Min.	Shell Size	Max	Min																																							
8	8 (.90)	1 (.11)	18	28 (3.16)	4 (.45)																																							
10	12 (1.36)	1 (.11)	20	32 (3.62)	6 (.68)																																							
12	16 (1.81)	2 (.23)	22	36 (4.07)	7 (.79)																																							
14	20 (2.26)	4 (.45)	24	44 (4.97)	7 (.79)																																							
16	24 (2.71)	4 (.45)																																										
Durability	4.6.17	Connector halves shall be mated and unmated 500 times at a rate of 200 ± 100 cycles per hour. The test may be performed by hand or by mechanical means, but the coupling ring shall be operated as in normal service. Failure to complete this test because of mechanical malfunction shall be cause for rejection.																																										
Insert Retention	4.6.29	Connectors with the endbells and grommets (if possible) removed shall be subjected to a 75 psi load on the insulator in both directions. The load shall be applied at a rate of 10lb/sec. and held for 5 to 10 secs. Insulators shall not be dislodged from their original position.																																										
Insulation Resistance	4.6.7.1	On unmated connectors at 25°C ±3°C a potential of 500 VDC ±10% shall be applied between all, but not more than 6, pairs of adjacent contacts and between all, but not more than 6, contacts and the shell. Failure to meet a minimum requirement of 5,000 megohms shall be cause for rejection.																																										
Vibration	4.6.21	Wired, mated connectors shall be subjected to the vibration test of MIL-STD-1344, Method 205, Test Condition II. Receptacles shall be mounted on the vibration fixture by normal means. All contacts shall be wired in a series circuit and 100 max. milliampere of current shall be allowed to flow through the series circuit during vibration. Suitable means shall be employed to monitor the current flow and to indicate any discontinuity of more than 10 microseconds. The wire bundle shall be clamped to nonvibrating points at least 8 inches from the rear of the connector. Current discontinuity of 10 microseconds or more, disengagement of the mated connectors, evidence of cracking, breaking, or loosening of parts shall be cause for rejection.																																										
Shock	4.6.23	Wired, mated connectors shall be subject to one shock in each direction in each of three mutually perpendicular axes. The pulse shall be approximate half sine wave of 50g±15% magnitude with a duration of 11 ± 1 milliseconds. Receptacles shall be mounted on a shock fixture by normal means. All contacts shall be wired in a series circuit and 90-110 ma. of current shall flow through the series circuit during shock. Suitable means shall be employed to monitor the current flow and to indicate any discontinuity of more than 10 microseconds. Current discontinuity of 10 microseconds or more, disengagement of the mated connectors, evidence of cracking, breaking, or loosening of parts shall be cause for rejection.																																										
Thermal Shock	4.6.12	Wired, unmated plug and receptacle shall be subjected to 5 cycles of hot and cold temperatures. Maximum temperature shall be +125°C and the minimum shall be -55°C. The temperature extreme shall be 1/2 hour minimum. Cracking, breaking or loosening of parts shall be cause for rejection.																																										
Humidity	4.6.25	The connectors shall be subjected to varying humidity, 50% to 95%, conditions for a period of 10 days KRSE or 20 days KPT. The insulation resistance shall not be less than 100 megohms.																																										
Air Leakage (KPT Only)	4.6.15.1	A 30 psi pressure differential shall be applied across the connector for 30 minutes. The leak rate, in either direction, shall be no greater than 1 atmosphere cubic inch per hour (4,55 X 10 ⁻³ cm ³ /S) at -67°F (-55°C).																																										
Salt Spray (Corrosion)	4.6.19	Unmated and wired connectors shall be subject to a salt fog for 48 hours. These shall be no exposure of base metal, the connector shall be functional and meet the contact resistance requirement.																																										
Fluid Immersion	4.6.27	At least one connector, unmated and wired, shall be immersed in each fluid for a period of 20 hours then dried for an hour. Connectors shall be able to make and meet the coupling torque requirements. a) Hydraulic Fluid per MIL-H-5606, b) Lubricating Oil per MIL-L-7808																																										



A

Circular

Tooling Crimp

M22520/1-01 CRIMP TOOL
M22520/01-02 Turret



CBT-520/530

Tooling Insertion/Extraction



KPSE Insertion



KPSE Extraction

Contact Size	
20	MS24256A20
16	MS24256A16

Contact Size	
20	MS24256R20
16	MS24256R16

Contacts



#20

Contact Size/Type	Military Part Number	1st	Color Bands 2nd	3rd	ITT Cannon Part Number
20 Socket	M39029/32-259	Red	Green	White	980-0008-992
20 Pin	M39029/31-240	Red	Yellow	Black	030-9036-000
16 Socket	M39029/32-247	Red	Yellow	Violet	031-9095-003
16 Pin	M39029/31-228	Red	Red	Grey	030-9032-003

Wire Hole Fillers/Grommets Sealing Plugs

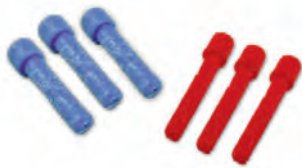

Contact Size	Part Number Cannon	Military	Color Code
20	225-1012-000	MS3187A20	Red
16	225-1011-000	MS3187-16	Blue



A

Circular

KPSE Assembly Instructions

Contact Size	Wire Size		Strip Insulation	mm
	AWG	mm ²		
20	#20-#24	.5 - .2	3/16"	4.76
16	#16-#20	1.3 - .5	1/4"	6.35

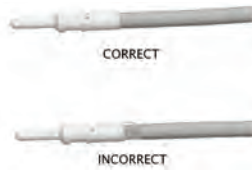

CRIMPING CONTACTS

1. Strip wires according to the table above taking care not to cut or nick strands.

2. Inserts stripped wire into contact crimp pot. Wire must be visible thru inspection hole.

3. Using correct tool and locator select proper crimp setting for wire sizer to be crimped; cycle the tool once to be sure the indentors are open. Insert contact and wire into locator. Squeeze tool handles firmly and completely to insure a proper crimp. The tool will not release unless the crimp indentors in the tool head have been fully actuated. Release crimped contact and wire from tool. Be certain the wire is visible thru inspection hole in contact. CAUTION: Check that none of the contacts are bent or damaged in any way after crimping.

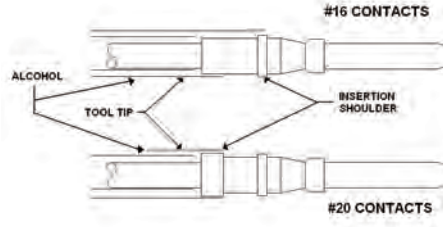
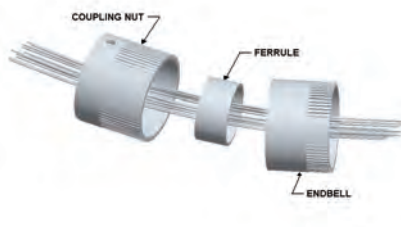

CONTACT INSERTION

1. Remove hardware from plug and receptacle. Slide hardware over wire bundle in proper order for reassembly.

2. Use the proper contact insertion tool and slide the tool over the terminal end of the contact. The size 16 contact lies in the tool and the tool tip butts against the contact shoulder. The rear, or insulation support of the size 20 contact butts against an internal shoulder in the tool tip.
NOTE: Apply a small amount of isopropyl alcohol to the insertion tool tip while installing contacts.

3. Beginning from center cavity and working outwards in a circular pattern, insert wired contacts into rear of connector by hand until the front of the contact shoulder is no more than 1/8" from the grommet. Holding the connector horizontally, position tool behind contact. Push tool straight into contact cavity until contact snaps into position. A light pull on wire will assure that contact is locked securely. Repeat for remaining contacts.



Size	Torque in-lb (NM)
8, 10, 12 and 14	10-15 (1.23-1.69)
16 and 18	15-25 (1.69-2.82)
20, 22 and 24	25-35 (2.82-3.95)

4. Use contacts and grommet sealing plugs to fill any empty cavities.

COMPLETION

4. Check face of plug or receptacle for proper contact installation.

2. Using mating connector with contacts installed, mate both connector halves together.

3. Assemble Ferrule over the grommet by hand as far as possible.

4. Assemble endbell over ferrule and loosely tighten endbell. Partially loosen (1/4 turn) and retighten to recommended torque limits.



CONTACT EXTRACTION

1. Slide hardware back over wire bundle. Using proper extraction tool or extraction end of proper insertion/extraction tool, proceed as follows:

KPSE: There are two lines on the clip sleeve which are vital to the removal process. The first index line is used for removing pin contacts while the second index line is for removing socket contacts.

Carefully place the tool tip over the contact to be extracted until the tool tip touches the insulator face. Carefully rotate the tool until the index line is slightly below the insulator face. Keep an even pressure against the tool body; push plunger forward with thumb and index finger, and push the contact out through the clip. Carefully remove extraction tool from connector. Pull wire by hand to complete the removal of the contact.



A

Circular

How to Order - Special Termination Connectors



KPT	03	-	18	-	32	P	W
KPT	04	-	18	-	32	P	W
KPT	05	-	18	-	32	P	W
KPSE	03	-	18	-	32	P	W
KPSE	04	-	18	-	32	P	W
KPSE	05	-	18	-	32	P	W

- PREFIX _____
- SHELL STYLE _____
- DASH (No Class required, less rear termination) _____
- SHELL SIZE _____
- CONTACT ARRANGEMENT _____
- CONTACT TYPE _____
- P - PIN
- S - Socket
- ALTERNATE INSERT POSITION _____

Contact ITT Cannon for additional Information

Solder Type KPT03/04/05 - Supplied less endball, ferrule and grommet.

KPT03



KPT04



KPT05



Crimp Type KPSE03/04/05 - Supplied less endball, ferrule.

KPSE03



KPSE04



KPSE05



Twist Pull Lanyard Release Coupler Plug

KPT06/KPSE06



KPT	6	A	22	-	55	P	W	16
KPSE	6	E	22	-	55	S	Z	16

- PREFIX _____
- SHELL STYLE _____
- SERVICE TYPE _____
- SHELL SIZE _____
- CONTACT ARRANGEMENT _____
- CONTACT TYPE _____
- POLARIZATION _____
- MODIFICATION CODE* _____

*Omit (0) of shell style indication when using this modification code.

16 = Overall length of connector including lanyard to be 6.0 (152.40) ± .125 (3.18) when measured over a 1.0 (25.40) ± .005 (0.13) diameter mandrel.





A

Circular

Cross Reference List KPT/MIL-C-26482, VG 95328

Part No. ITT Cannon	Part No. MIL-26482	Part No. VG 95328
KPT00B*_***		
KPT00E*_***	MS3110E*_***	
KPT00F*_***	MS3110F*_***	
KPT00G*_***		
KPT00J*_***	MS3110J*_***	
KPT00P*_***	MS3110P*_***	
KPT0E*_***DN		
KPT0E*_***DZ		
KPT01A*_***		
KPT01B*_***		
KPT01E*_***	MS3111E*_***	
KPT01F*_***	MS3111F*_***	
KPT01G*_***		
KPT01J*_***	MS3111J*_***	
KPT01P*_***	MS3111P*_***	
KPT1E*_***DN		
KPT06A*_***		
KPT06B*_***		
KPT06E*_***	MS3116E*_***	
KPT06F*_***	MS3116F*_***	
KPT06G*_***		
KPT1E*_***DZ		
KPT06J*_***	MS3116J*_***	
KPT06P*_***	MS3116P*_***	
KPT6A*_***88		
KPT6E*_***DN		
KPT6E*_***DZ		
KPT02E*_***	MS3112E*_***	H*_***VG 95328
KPT07A*_***		
KPT07E*_***	MS3114E*_***	
KPT07F*_***	MS3114F*_***	
KPT08E*_***		
KPT08F*_***		
KPT08P*_***		
KPT7E*_***DN		
KPTB*_***	MS3119E*_***	

Cross Reference List List Protective Caps

Part No. ITT Cannon	Part No. MIL-26482	Part No. VG 95328
KPT80	MS 3180	
KPT80...C	MS 3180...C	Z 2...VG 95328
KPT81	MS 3181	
KPT81...C	MS 3181...C	Z 1...VG 95328
KPT81...N	MS 3181...N	

Dimensions shown in inches (mm)
Specifications and dimensions subject to change



Cannon KPT/KPSE MIL-C-26482 Series I Connectors



A

Circular

Cross Reference List KPSE/MIL-C-26482, VG 95328

Part No. KPSE ITT Cannon	Part No. MIL-C-26482	Part No. VG 95328
KPSE00A*_*_*_*_*		
KPSE00B*_*_*_*_*		
KPSE00E*_*_*_*_*	MS3120E*_*_*_*_*	A*_*_*_*_*VG 95328
KPSE00F*_*_*_*_*	MS3120F*_*_*_*_*	B*_*_*_*_*VG 95328
KPSE0E*_*_*_*_*DZ		R*_*_*_*_*VG 95328
KPSE00J*_*_*_*_*		
KPSE00P*_*_*_*_*	MS3120P*_*_*_*_*	
KPSE0E*_*_*_*_*DN		
KPSE00G*_*_*_*_*		
KPSE01A*_*_*_*_*	25101RA*_*_*_*_*50	
KPSE01B*_*_*_*_*		
KPSE01E*_*_*_*_*	MS3121E*_*_*_*_*	
KPSE01F*_*_*_*_*	MS3121F*_*_*_*_*	
KPSE01G*_*_*_*_*		
KPSE01J*_*_*_*_*		
KPSE01P*_*_*_*_*	MS3121P*_*_*_*_*	
KPSE*_*_*_*_*DN		
KPSE02E*_*_*_*_*	MS3122E*_*_*_*_*	C*_*_*_*_*VG 95328
KPSE06A*_*_*_*_*		
KPSE06B*_*_*_*_*		
KPSE06E*_*_*_*_*	MS3126E*_*_*_*_*	
KPSE06F*_*_*_*_*	MS3126F*_*_*_*_*	K*_*_*_*_*VG 95328
KPSE06G*_*_*_*_*		
KPSE06J*_*_*_*_*		
KPSE06P*_*_*_*_*	MS3126P*_*_*_*_*	
KPSE6A*_*_*_*_*88		
KPSE6E*_*_*_*_*88		N*_*_*_*_*VG 95328
KPSE6E*_*_*_*_*DN		J*_*_*_*_*VG 95328
KPSE6E*_*_*_*_*DZ		M*_*_*_*_*VG 95328
KPSE07A*_*_*_*_*		
KPSE1E*_*_*_*_*DZ		
KPSE7E*_*_*_*_*DN		S*_*_*_*_*VG 95328
KPSE07E*_*_*_*_*	MS3124E*_*_*_*_*	D*_*_*_*_*VG 95328
KPSE07F*_*_*_*_*	MS3124F*_*_*_*_*	E*_*_*_*_*VG 95328
KPSE08E*_*_*_*_*		
KPSE08F*_*_*_*_*		
KPSE08P*_*_*_*_*		
KPSE7E*_*_*_*_*DZ		T*_*_*_*_*VG 95328



Dimensions shown in inches (mm)
Specifications and dimensions subject to change

www.ittcannon.com