

DC Brushless Fan Motor Drivers

5V Single-phase Full-wave Fan Motor Driver

BU69090NUX

General Description

The BU69090NUX is a 5V single-phase full-wave FAN motor driver with built in HALL element. It is part of the DC brushless FAN motor driver series. BU69090NUX is built in a compact package and provides Auto Gain Control (AGC) function, silent drive by soft switching, and low battery consumption via its standby function. BU69090NUX is best used for notebook PC cooling FANs.

Key Specifications

- Input Voltage Range: 1.8V to 5.5V
- Operating Temperature Range: -40°C to +85°C
- Output Voltage (High and Low Total): 0.16V(Typ) at 0.2A

Features

- Built in HALL Element
- AGC Function
- PWM Speed Control
- Soft Switching Drive (PWM Type)
- Low PWM Duty Start Assist Function
- Quick Start Function
- Stand-by Mode
- Lock Protection and Automatic Restart
- Compact Package
- Rotating Speed Pulse Signal (FG) Output

Applications

- For compact 5V FAN such as notebook PC cooling FAN

Package

VSON008X2030

W(Typ) x D(Typ) x H(Max)

2.00mm x 3.00mm x 0.60mm



Typical Application Circuit

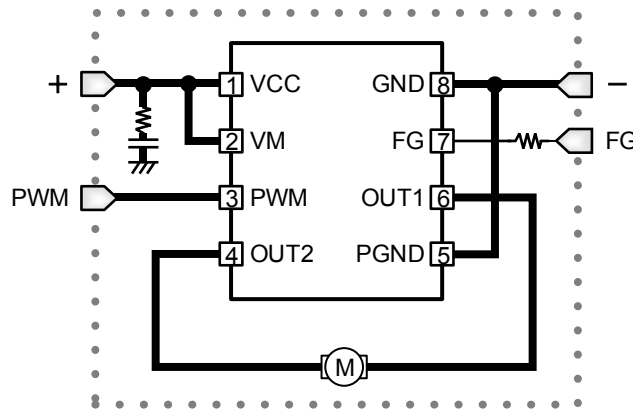

Figure 1. Application circuit

Pin Configuration

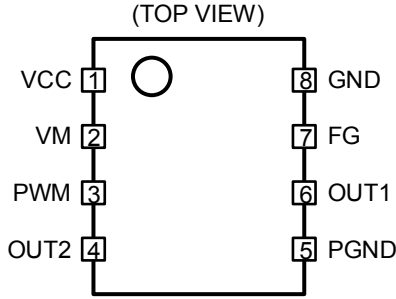

Figure 2. Pin Configuration

Pin Description

P/No.	P/Name	Function
1	VCC	Power supply 1
2	VM	Power supply 2
3	PWM	PWM signal input
4	OUT2	Motor output 2
5	PGND	Ground 2
6	OUT1	Motor output 1
7	FG	FG signal output
8	GND	Ground 1

Block Diagram

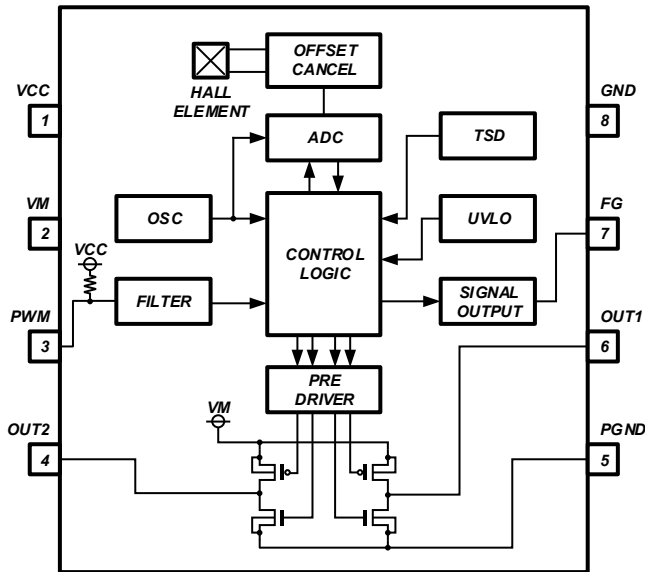
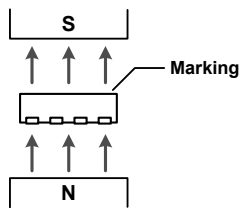

Figure 3. Block Diagram

I/O Truth Table

• Supply magnetic direction (positive)



• Output operation

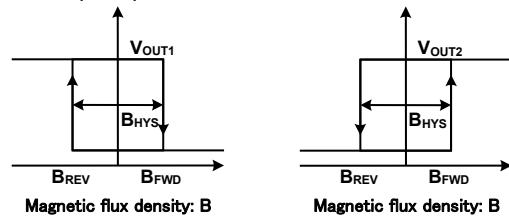

Figure 4. Output operation

Supply magnetic direction	PWM <i>(Note 1)</i>	OUT1	OUT2	FG
S	H(OPEN)	L	H	Hi-Z
N	H(OPEN)	H	L	L
S	L	Hi-Z	Hi-Z	Hi-Z
N	L	Hi-Z	Hi-Z	Hi-Z

H; High, L; Low, Hi-Z; High Impedance

FG output is open-drain type.

(Note1) When PWM terminal is L, IC state changes to stand-by mode. FG terminal is always H in stand-by mode

Absolute Maximum Ratings

Parameter	Symbol	Rating	Unit
Supply Voltage	V _{CC}	7	V
Operating Temperature Range	Topr	-40 to +85	°C
Storage Temperature Range	Tstg	-55 to +125	°C
Output Voltage	V _O	7	V
Output Current	I _O	0.8 ^(Note 1)	A
FG Signal Output Voltage	V _{FG}	7	V
FG Signal Output Current	I _{FG}	10	mA
Junction Temperature	T _J	125	°C

(Note 1) Do not exceed T_{Jmax}.

Caution: Operating the IC over the absolute maximum ratings may damage the IC. The damage can either be a short circuit between pins or an open circuit between pins and the internal circuitry. Therefore, it is important to consider circuit protection measures, such as adding a fuse, in case the IC is operated over the absolute maximum ratings.

Thermal Resistance ^(Note 1)

Parameter	Symbol	Thermal Resistance (Typ)		Unit
		1s ^(Note 3)	2s2p ^(Note 4)	
VSONX0082030				
Junction to Ambient	θ _{JA}	308.3	69.6	°C/W
Junction to Top Characterization Parameter ^(Note 2)	Ψ _{JT}	43	10	°C/W

(Note 1) Based on JESD51-2A(Still-Air)

(Note 2) The thermal characterization parameter to report the difference between junction temperature and the temperature at the top center of the outside surface of the component package.

(Note 3) Using a PCB board based on JESD51-3.

Layer Number of Measurement Board	Material	Board Size
Single	FR-4	114.3mm x 76.2mm x 1.57mm
Top		
Copper Pattern	Thickness	
Footprints and Traces	70μm	

(Note 4) Using a PCB board based on JESD51-5, 7.

Layer Number of Measurement Board	Material	Board Size	Thermal Via ^(Note 5)		
			Pitch	Diameter	
4 Layers	FR-4	114.3mm x 76.2mm x 1.6mm	1.20mm	Φ0.30mm	
Top		2 Internal Layers		Bottom	
Copper Pattern	Thickness	Copper Pattern	Thickness	Copper Pattern	Thickness
Footprints and Traces	70μm	74.2mm x 74.2mm	35μm	74.2mm x 74.2mm	70μm

(Note 5) This thermal via connects with the copper pattern of all layers..

Recommended Operating Conditions

Parameter	Symbol	Min	Typ	Max	Unit
Operating Supply Voltage Range	V_{CC}	1.8	5.0	5.5	V
Input Voltage Range (PWM)	V_{IN}	0	-	5.5	V
PWM Input Duty Range	D_{PWM}	0	-	100	%
PWM Input Frequency Range	f_{PWM}	5	25	50	kHz

Electrical Characteristics (Unless otherwise specified $V_{CC}=5V$ $T_a=25^{\circ}C$)

Parameter	Symbol	Min	Typ	Max	Unit	Conditions
Circuit Current 1	I_{CC1}	-	2	4	mA	PWM=OPEN
Circuit Current 2 (Stand-by mode)	I_{CC2}		35	50	μA	PWM=GND
Magnetic Switch-point for Forward Rotation	B_{FWD}	-	1.5	-	mT	
Magnetic Switch-point for Reverse Rotation	B_{REV}	-	-1.5	-	mT	
Magnetic Hysteresis	B_{HYS}	-	3.0	5.0	mT	
PWM Input H Level	V_{PWMH}	2.5	-	V_{CC}	V	
PWM Input L Level	V_{PWML}	0	-	0.7	V	
Output Voltage	V_O	-	0.16	0.24	V	$I_O=200mA$, High and Low Total
FG Low Voltage	V_{FGL}	-	-	0.4	V	$I_{FG}=5mA$
FG Leak Current	I_{FGL}	-	-	5	μA	$V_{FG}=7V$
Lock Detection ON Time	t_{ON}	0.35	0.50	0.65	s	
Lock Detection OFF Time	t_{OFF}	3.5	5.0	6.5	s	

Typical Performance Curves

(Reference data)

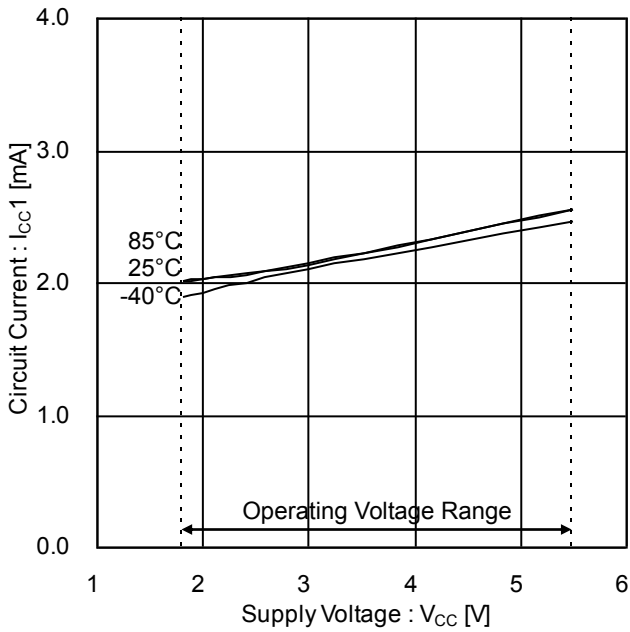

Figure 5. Circuit Current 1

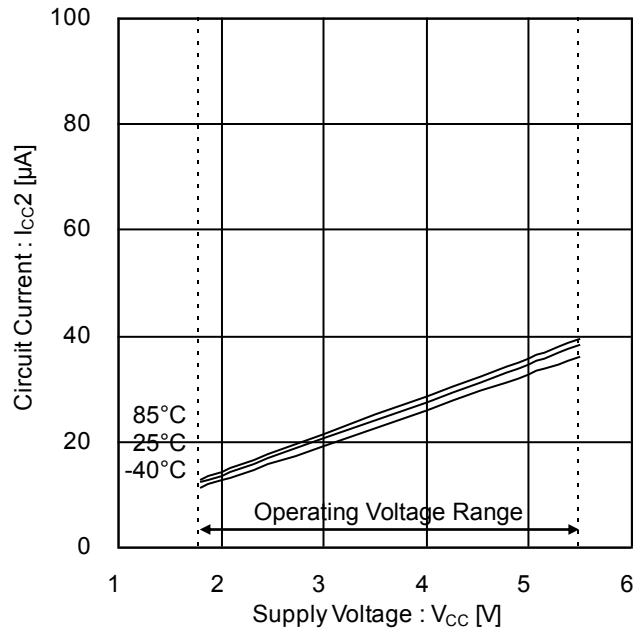

Figure 6. Circuit Current 2 (Stand-by mode)

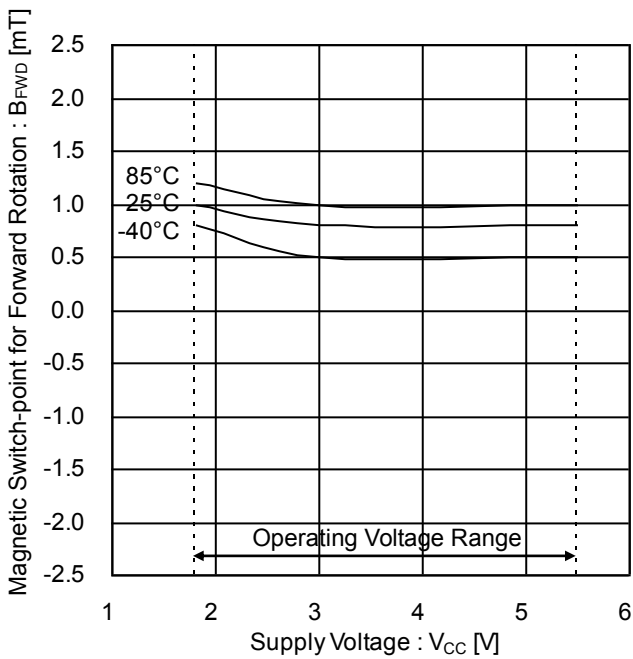

Figure 7. Magnetic Switch-point for Forward Rotation

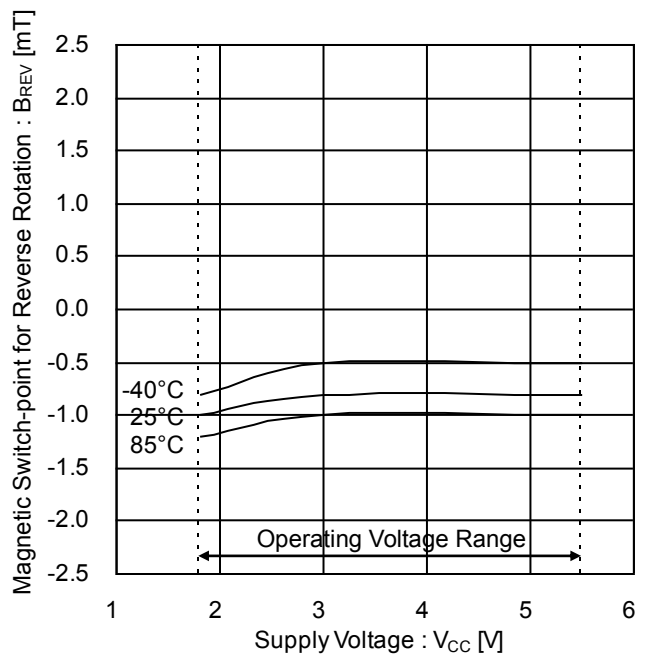

Figure 8. Magnetic Switch-point for Reverse Rotation

Typical Performance Curves - continued
(Reference data)

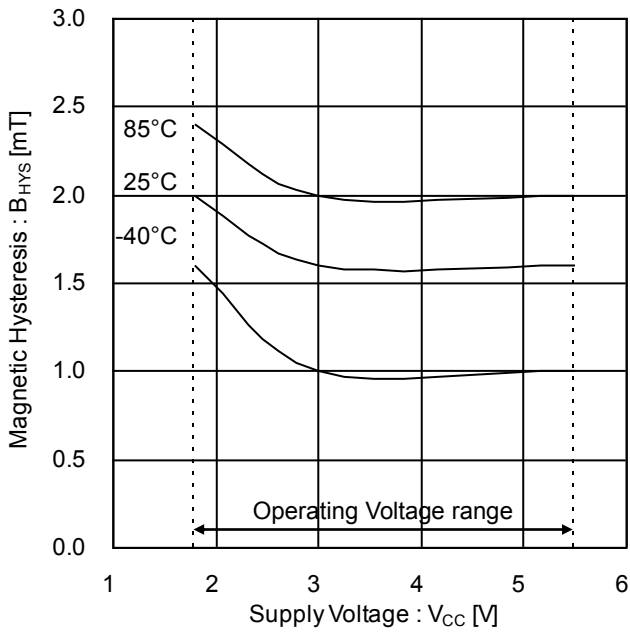

Figure 9. Magnetic hysteresis

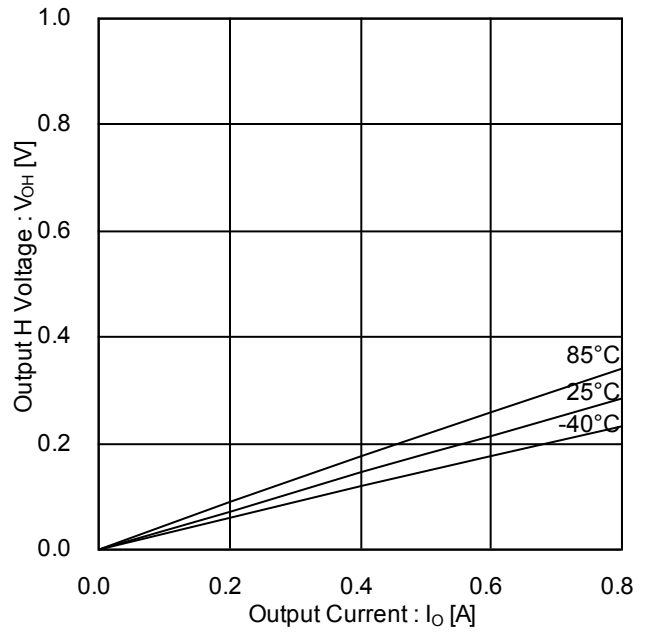

Figure 10. Output H Voltage
(Temperature Characteristics)

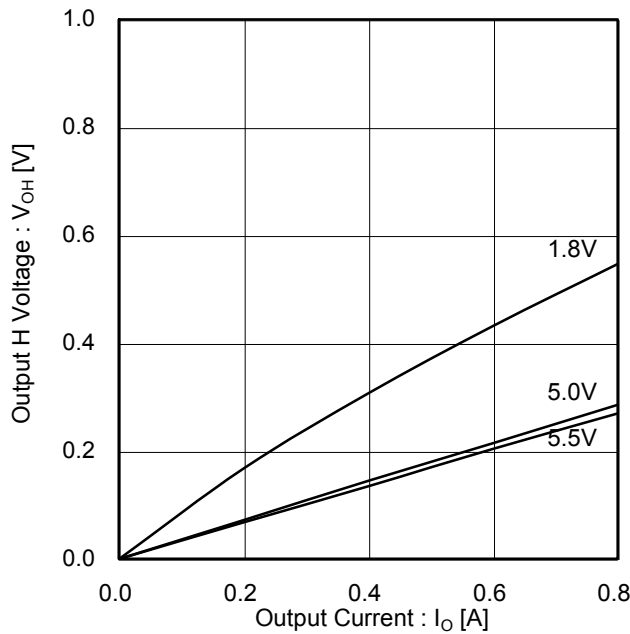

Figure 11. Output H Voltage
(Voltage Characteristics)

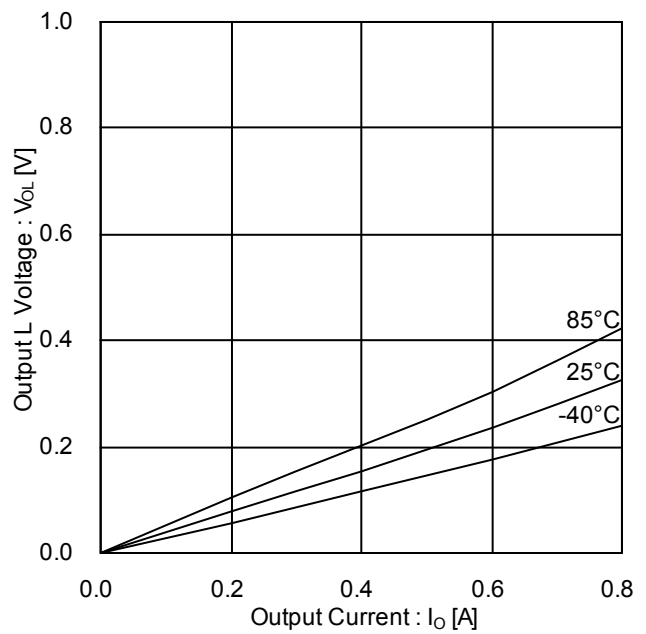

Figure 12. Output L Voltage
(Temperature Characteristics)

Typical Performance Curves - continued
(Reference data)

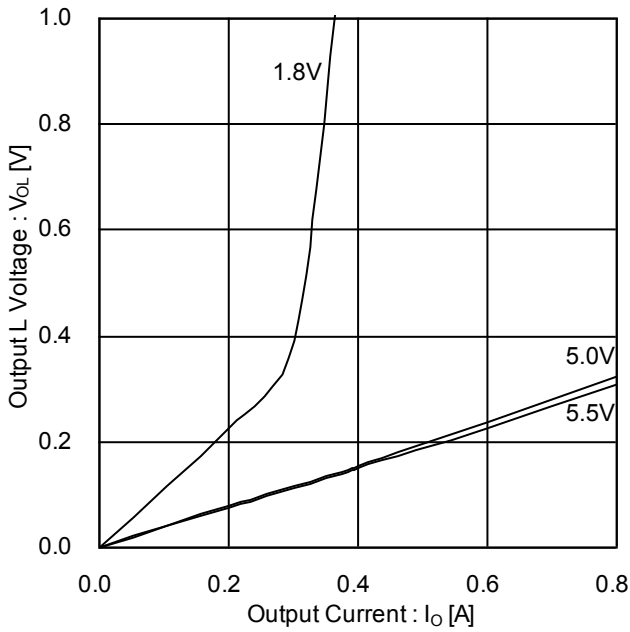

Figure 13. Output L Voltage (Voltage Characteristics)

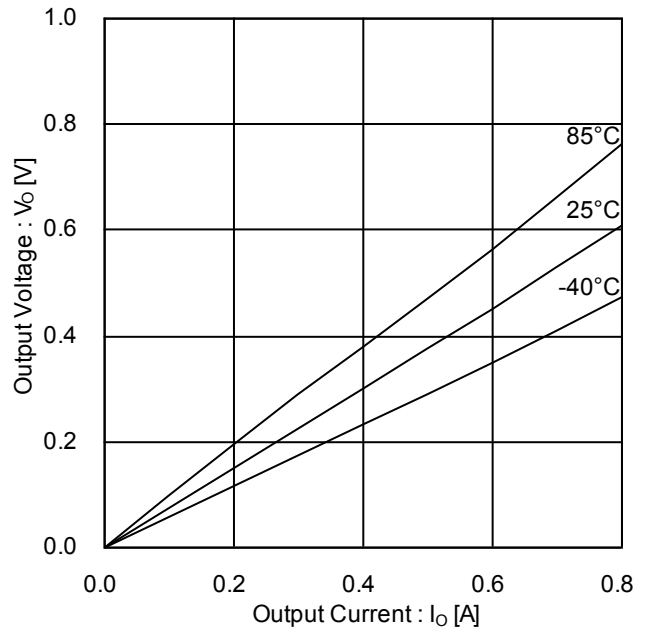

Figure 14. Output Voltage (High and Low Total) (Temperature Characteristics)

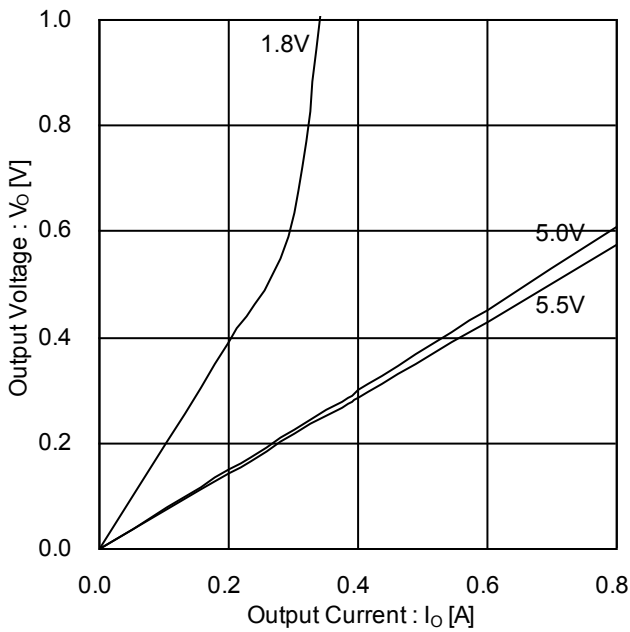

Figure 15. Output Voltage (High and Low Total) (Voltage Characteristics)

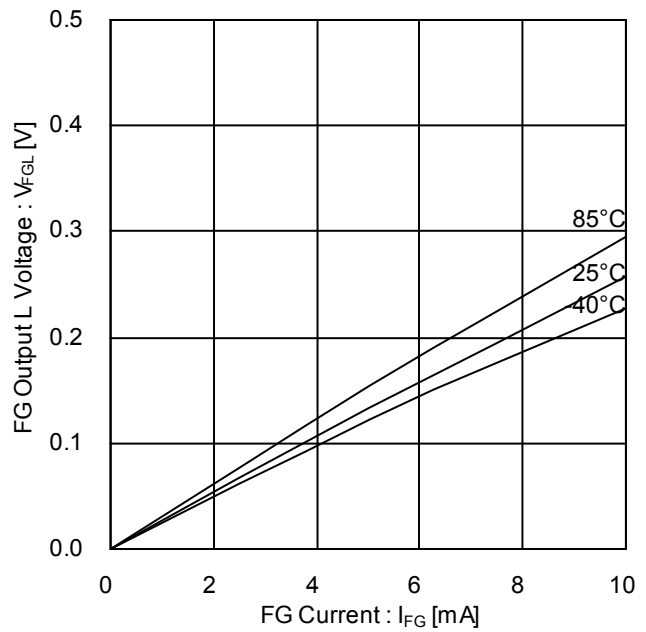

Figure 16. FG Output L Voltage (Temperature Characteristics)

Typical Performance Curves - continued

(Reference data)

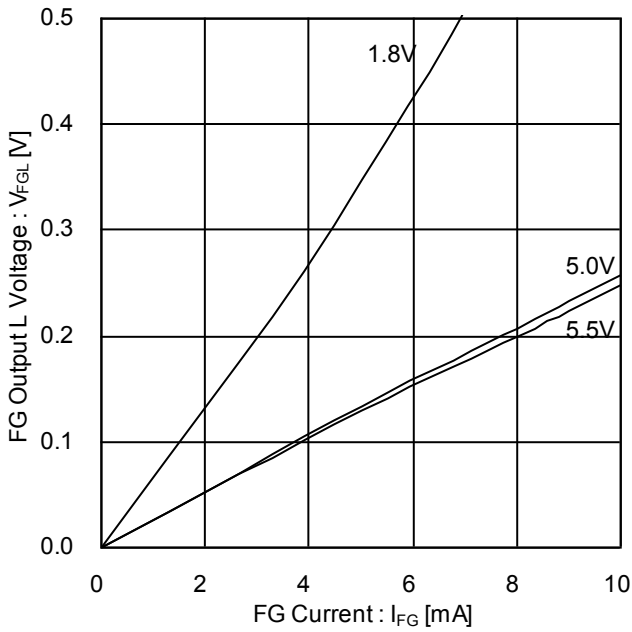

Figure 17. FG Output L Voltage (Voltage Characteristics)

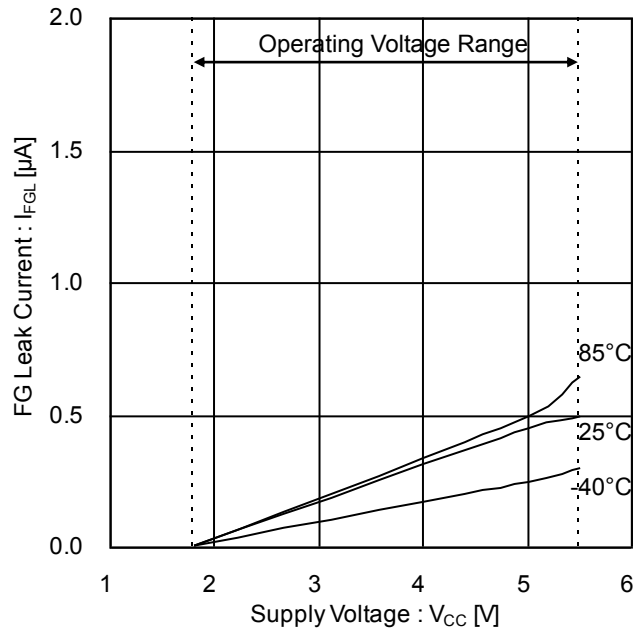

Figure 18. FG Output Leak Current

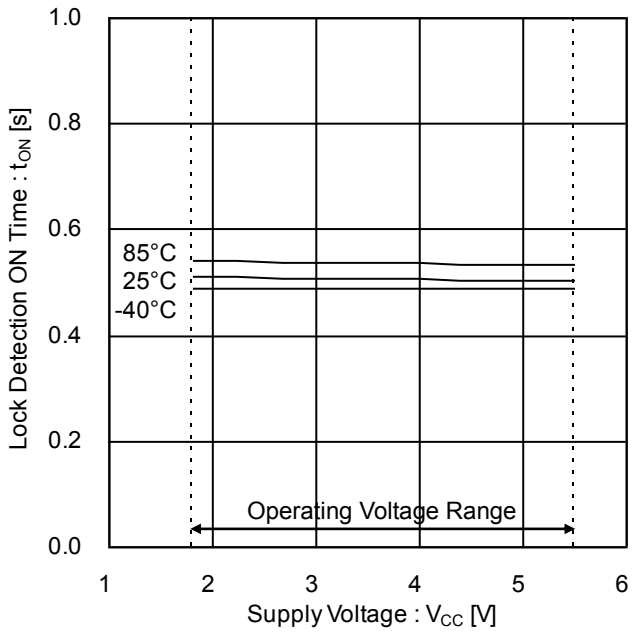

Figure 19. Lock Detection ON Time

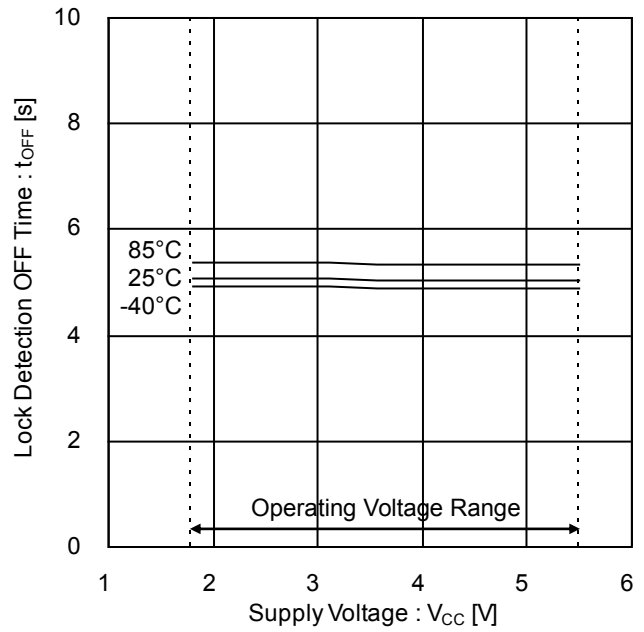

Figure 20. Lock Detection OFF Time

Application Example

Consider protection against voltage rise due to reverse connection of power supply and back electromotive force.
 Page 16.

VCC and VM should be shorted. Cannot use this IC in two power supply configuration.

Enables speed control by applying external PWM signal.
 Page 12.

Conventional FAN motor driver IC with HALL element requires adjustment of HALL bias resistor due to several factors that affect the HALL Amplitude. This IC automatically adjusts HALL amplitude through the use of a built in HALL element and unique AGC function.
 Page 10.

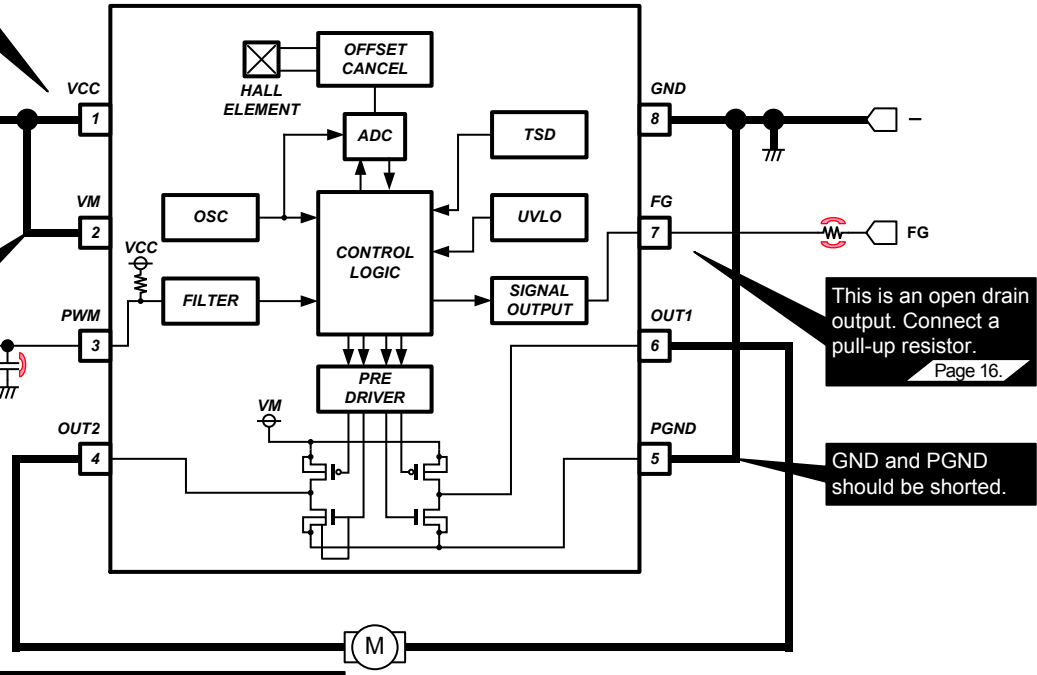

This is an open drain output. Connect a pull-up resistor.
 Page 16.

GND and PGND should be shorted.

Figure 21. Application Example

Substrate Design Note

- (a) IC power, Motor outputs, and Motor ground lines should be made as wide as possible.
- (b) IC ground line is common with the application ground except motor ground, and arranged near to (-) land.
- (c) The bypass capacitor and/or Zener diode are placed near to VCC pin.

Functional Descriptions

1. Auto Gain Control (AGC) Function

Conventional FAN motor driver IC with HALL element requires adjustment of HALL bias resistor for acoustic noise characteristic and motor rotation efficiency because the magnetic field strength and the magnetic field waveform are different in each motor. This IC automatically controls HALL amplitude generated by built in HALL element and motor magnet through the use of a unique AGC function. AGC function needs 15 ms to select the required HALL amp gain when turning on the power, and recovering from stand-by mode and lock protection.

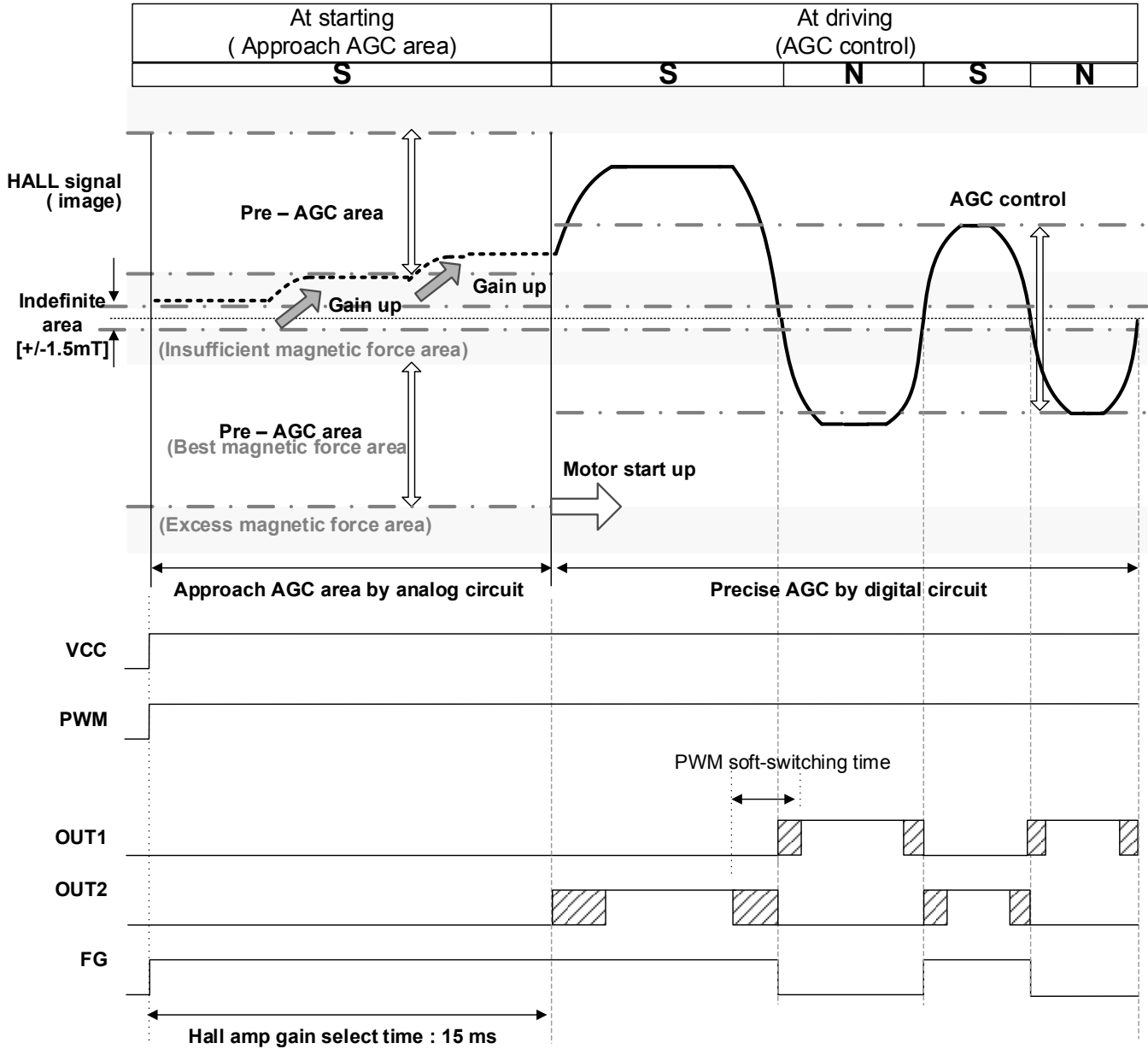

Figure 22. AGC Image of the Hall signal (In case of weak magnetic field)

After the startup, the Hall signal is increased by Hall amplifier gain. The increased Hall signal is set by the AGC around the Pre-AGC area, the weak magnetic field of the motor as in Figure 22. To selecting a gain requires about 15ms before it activates the motor.

2. Soft Switching Drive (PWM type)

Soft Switching Drive is operated using an output PWM pulse. The output PWM signal is generated by the slope of processed AGC HALL signal. First, the processed AGC HALL signal is converted to absolute waveform. Next, the absolute waveform and the triangular waveform internally generated by the IC are synthesized. The synthesized waveform determines the PWM soft switching duty and the ratio of time.

PWM soft switching time depends on motor speed. In case of a slower HALL signal, PWM soft switching time is long due to the obtuse angle of the processed AGC HALL signal (PWM soft switching time is about 2ms to 4ms.). In case of a faster HALL signal, PWM soft switching time is short due to the sharp slope of the AGC HALL signal (PWM soft switching time is about 200μs to 1ms.). And, the triangular wave oscillator inside the IC uses a PWM soft switching frequency of 50kHz (Typ). Hence, input PWM frequency is not equal to PWM soft switching frequency.

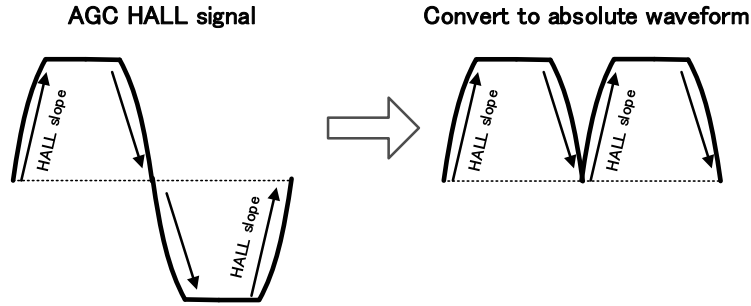

(a) The processed AGC HALL signal is converted to absolute waveform

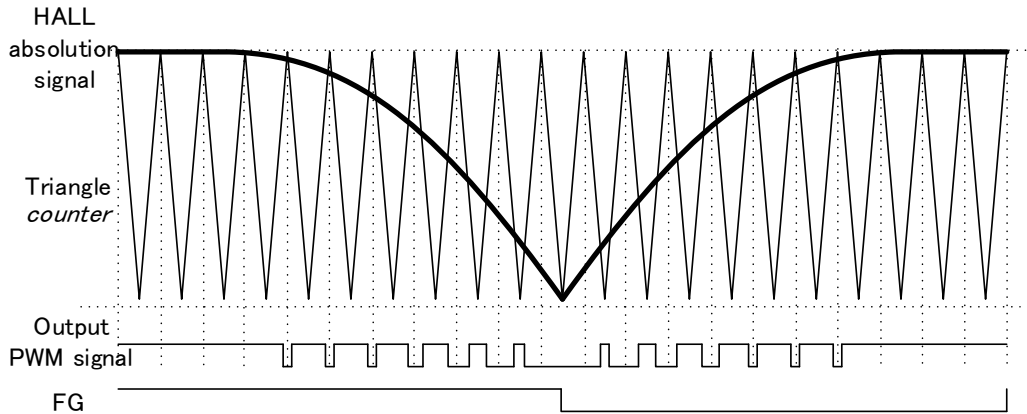

(b) Motor speed is slow

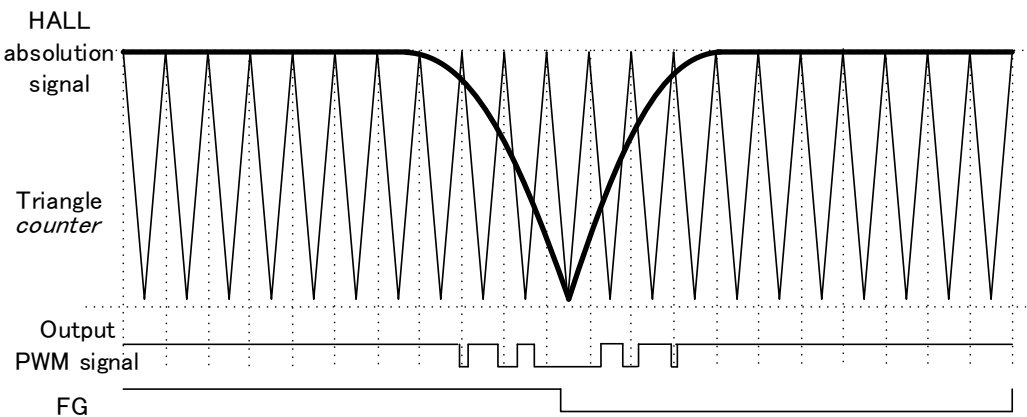

(c) Motor speed is fast

Figure 23. PWM soft switching signal synthesis

3. PWM Speed Control

Rotation speed of motor can be changed by controlling ON/OFF of the high output depending on the duty of the input signal to PWM terminal. When PWM terminal is open, H logic is applied. Output PWM frequency is 50 kHz (Typ). This IC is not direct PWM. Hence, input PWM frequency is not equal to output PWM frequency. Figure 24 shows the characteristic of input PWM duty and output PWM duty.

PWM terminal has a built in digital low pass filter (LPF). Output PWM duty has 3.5ms (Max) transitional time from the point of change in input PWM duty, this is caused by the LPF characteristic (reference is shown in Figure 25). Additionally, Input PWM uses frequencies between 5 kHz and 50 kHz.

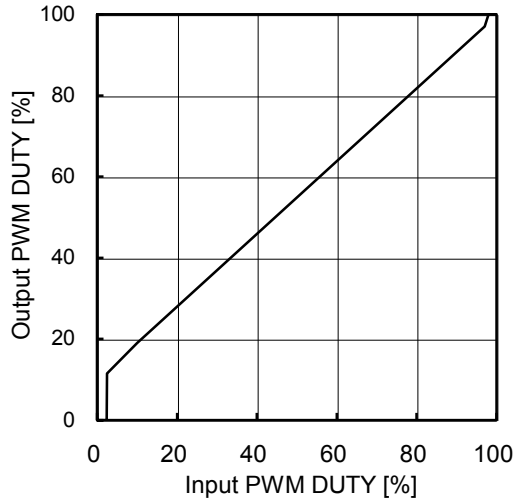

Figure 24. Characteristic of input PWM DUTY and output PWM DUTY

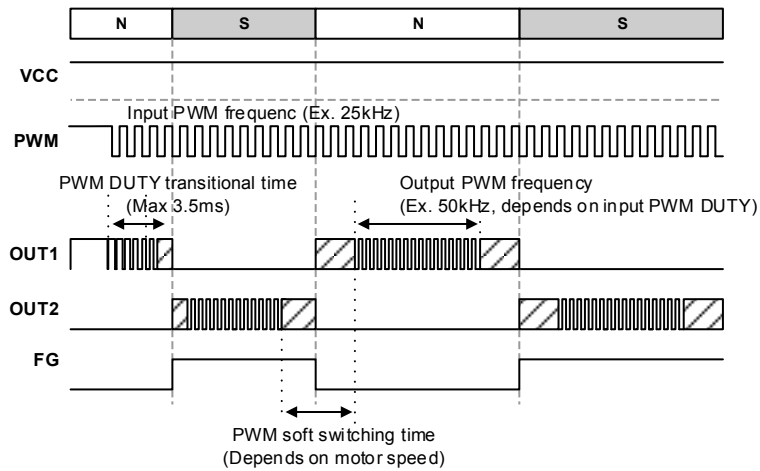

Figure 25. Timing chart of PWM control

4. Low PWM Duty Start Assist Function

During motor start up from stop condition, outputs are driven by a PWM signal of about PWM 50% duty for 3 times of changing magnetic direction. After the Low PWM Duty Start Assist function, output PWM duty changes corresponding to the input PWM duty. For cases of input PWM duty range of more than 50%, output PWM duty changes corresponding to same input PWM duty at all driving time. This function enables the IC to start the motor regardless of input PWM signal's duty.

When input PWM duty is 0%, the motor is held on stand-by mode. Additionally, the motor changes to idling mode for input PWM duty range of 0% to 2.5%. Idling mode only runs on circuit current 1 (I_{cc1}) in the Electrical Characteristics table. Idling mode turns all output terminals to open state.

e.g. PWM : 25kHz, DUTY20%

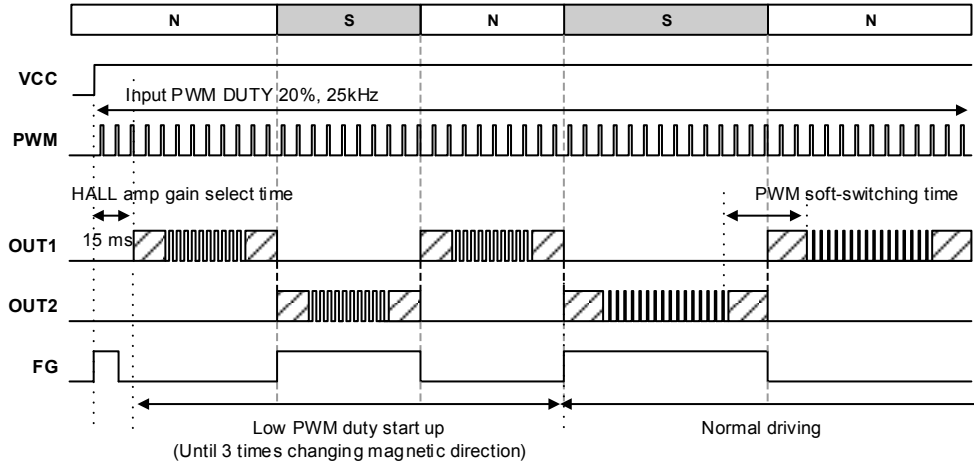

(a) Case A : Input PWM DUTY 2.5% to 50%

e.g. PWM : 25kHz, DUTY80%

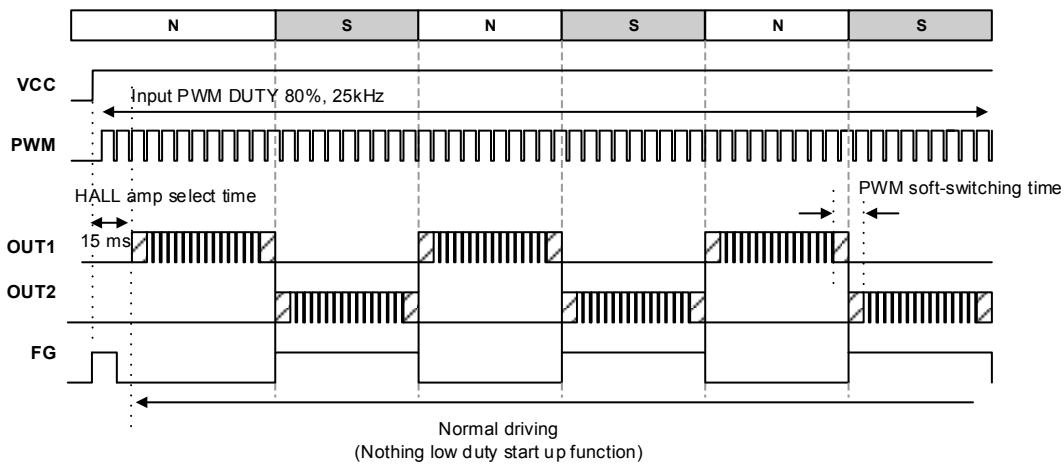

(b) Case B : Input PWM DUTY 50% to 100%

Figure 26. Low PWM Duty Start Assist Function

Table 1. Truth table of input PWM duty and each outputs terminals

Input PWM duty [%]	IC function (state)	OUT1, OUT2	FG
DUTY 0	OFF (Stand-by mode)	Hi-Z, Hi-Z	Hi-Z
DUTY 0 < 2.5	ON (Idle mode)	Hi-Z, Hi-Z	Hi-Z
Case A : DUTY 2.5 to 50	ON (Low duty start up driving)	H / L, L / H	Hi-Z / L
Case B : DUTY 50 to 100	ON (Normal driving)	H / L, L / H	Hi-Z / L

H; High, L; Low, Hi-Z; High Impedance
 FG output is open-drain type.

5. Quick Start Function

This series has an integrated Quick Start Function. When the PWM signal is input, this function can start up the motor at once regardless of the detection time of the lock protection function. (Consider HALL amp gain select time. Reference is shown in Figure 27.)

6. Stand-by Mode

Stand-by Mode turns off the circuit when the time of PWM=L has elapsed in order to reduce stand-by current. The circuit current consumption during stand-by mode is specified at the parameter "Circuit current 2" of the electrical characteristics. Figure 27 shows the timing diagram of stand-by mode and quick start function.

The 0% detection time before the IC changes to stand-by mode is variable depending on the input PWM duty. This is because of the built in LPF at the PWM terminal. As an example, Figure 28 shows the characteristic curve of 0% detection time and input PWM duty for a 25kHz input PWM frequency.

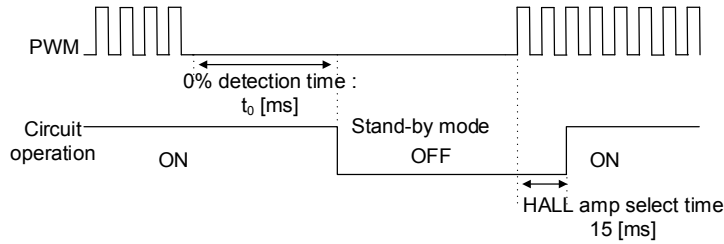

Figure 27. Stand-by Mode and Quick Start Function

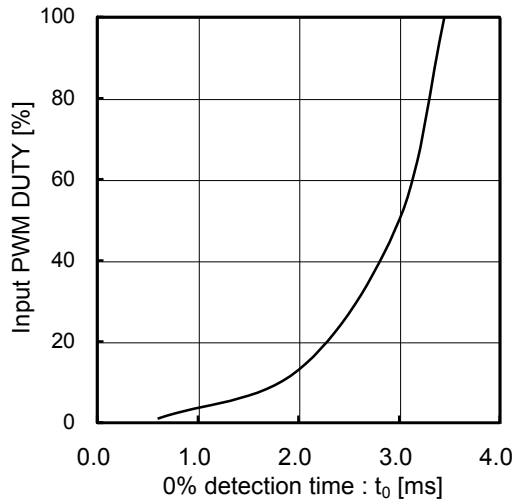

Figure 28. Characteristic curve of 0% detection time and input PWM duty at 25kHz

7. Lock Protection and Automatic Restart

Motor rotation is detected by HALL signal, while lock detection ON time (t_{ON}) and lock detection OFF time (t_{OFF}) are set by IC internal counter. External part (C or R) is not required. Timing chart is shown in Figure 29.

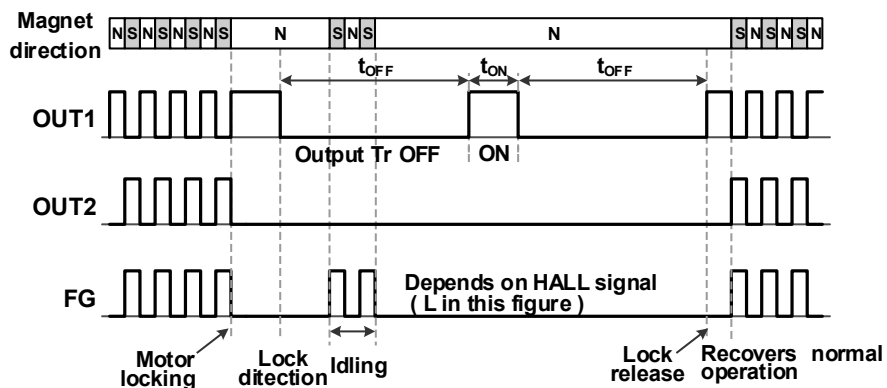

Figure 29. Lock protection timing chart

I/O Equivalence Circuit (Resistance Values are Typical)

1. VCC terminal,
GND, PGND terminals

2. OUT1, OUT2 terminals,
VM, GND, PGND terminals

3. PWM terminal

4. FG terminal

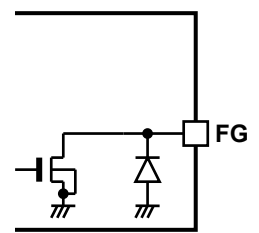
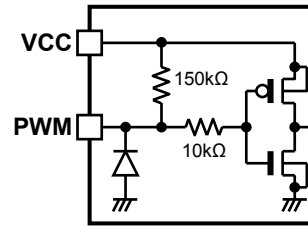
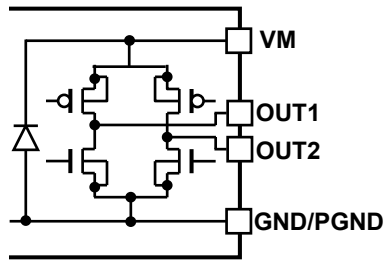
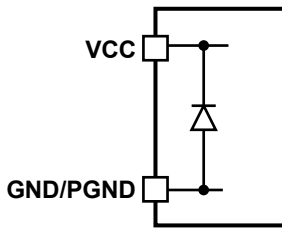

HALL position (Reference data)

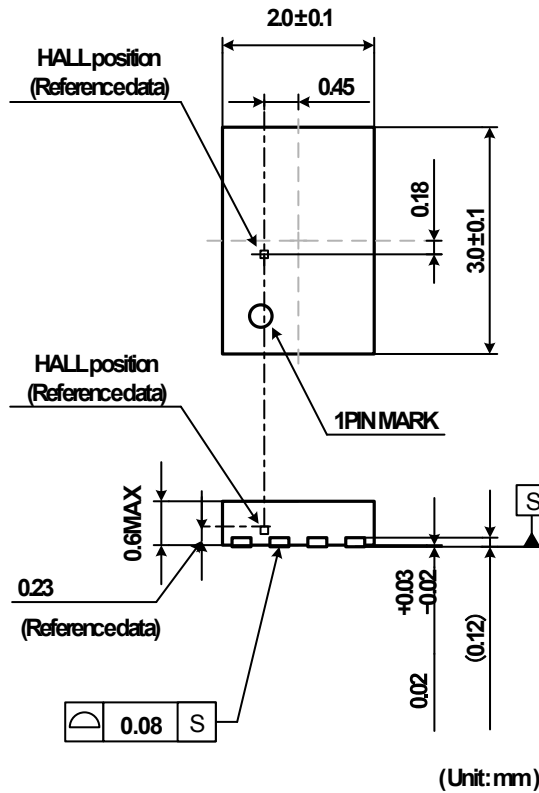

Safety Measure

1. Reverse Connection Protection Diode

Reverse connection of power results in IC destruction as shown in Figure 30. When reverse connection is possible, reverse connection protection diode must be added between power supply and V_{CC}.

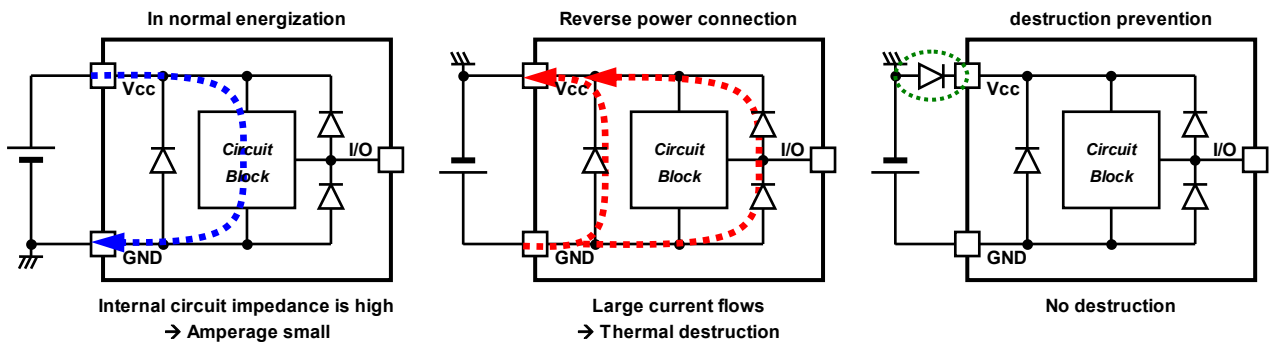

Figure 30. Flow of Current When Power is Connected Reversely

2. Protection against V_{CC} Voltage Rise by Back Electromotive Force

Back electromotive force (Back EMF) generates regenerative current to power supply. However, when reverse connection protection diode is connected, V_{CC} voltage rises because the diode prevents current flow to power supply.

When the absolute maximum rated voltage may be exceeded due to voltage rise by back electromotive force, place a (A) Capacitor or (B) Zener diode between V_{CC} and GND. If necessary, add both (C). (D) Capacitor and resistor can also be used to have better ESD surge protection.

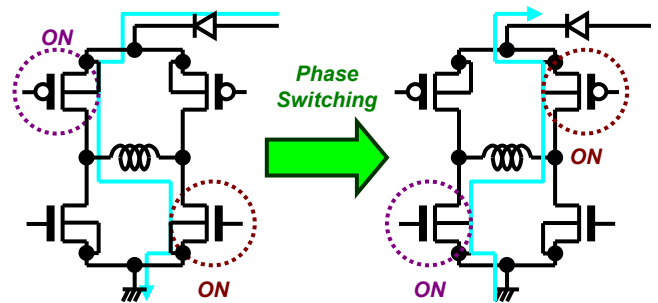

Figure 31. V_{CC} Voltage Rise by Back Electromotive

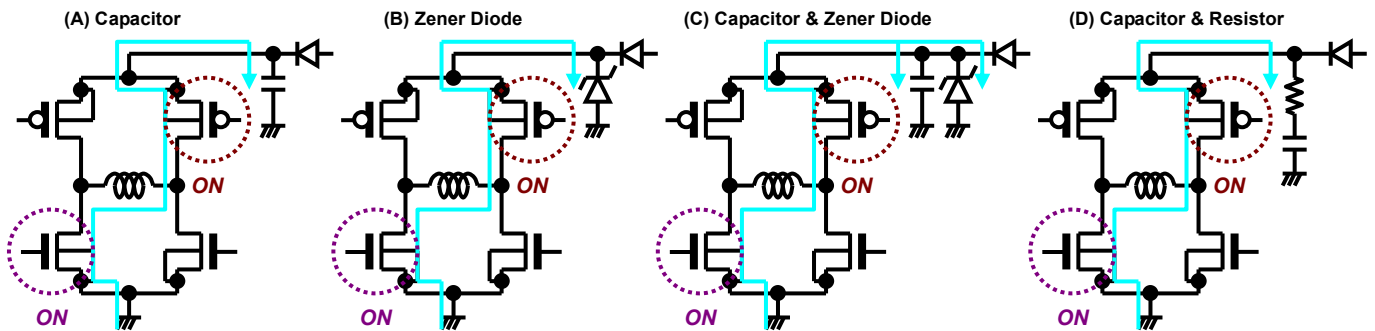

Figure 32. Measure against V_{CC} and Motor Driving Outputs Voltage

3. Problem of GND line PWM Switching

Do not perform PWM switching of GND line because GND terminal potential cannot be kept to a minimum.

4. Protection of Rotation Speed Pulse (FG) Open-Drain Output

FG output is an open drain and requires pull-up resistor. Adding resistor can protect the IC. Exceeding the absolute maximum rating, when FG terminal is directly connected to power supply, could damage the IC.

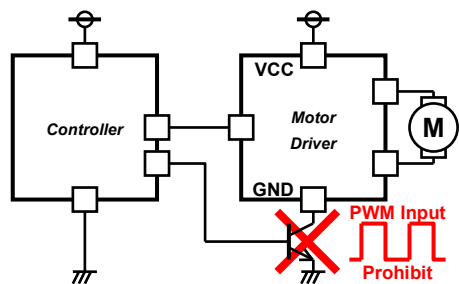

Figure 33. GND Line PWM Switching Prohibited

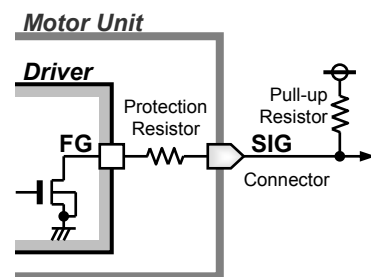

Figure 34. Protection of FG Terminal

Power Consumption

1. Current Pathway

The current pathways that relates to driver IC are the following, and shown in Figure 35.

- (1) Circuit Current (I_{CC})
- (2) Motor Current (I_M)
- (3) FG Output Sink Current (I_{FG})

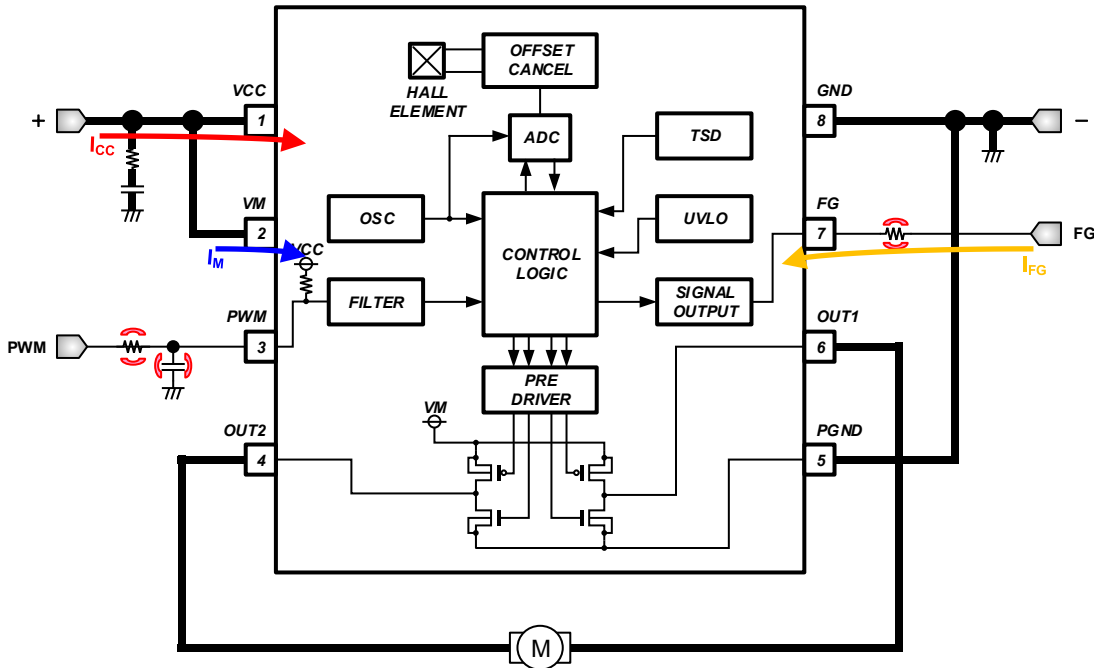

Figure 35. Current Pathway of IC

2. Calculation of Power Consumption

(1) Circuit Current (I_{CC})

$$P_{Wa}[W] = V_{CC}[V] \times I_{CC}[A] \text{ (} I_{CC} \text{ current doesn't include } I_M \text{)}$$

(ex.) $V_{CC} = 5.0[V]$, $I_{CC} = 2.0[mA]$

$$P_{Wa}[W] = 5.0[V] \times 2.0[mA] = 10.0 [mW]$$

(2) Motor Driving Current (I_M)

V_{OH} is the output saturation voltage of OUT1 or OUT2 high side, V_{OL} is the other low side voltage,

$$P_{Wb}[W] = (V_{OH}[V] + V_{OL}[V]) \times I_M[A]$$

(ex.) $V_{OH} = 0.08[V]$, $V_{OL} = 0.08[V]$, $I_M = 200[mA]$

$$P_{Wb}[W] = (0.08[V] + 0.08[V]) \times 200[mA] = 32.0[mW]$$

(3) FG Output Sink Current (I_{FG})

$$P_{Wc}[W] = V_{FG}[V] \times I_{FG}[A]$$

(ex.) $V_{FG} = 0.10[V]$, $I_{FG} = 5.0[mA]$

$$P_{Wc}[W] = 0.10[V] \times 5.0[mA] = 0.5[mW]$$

Total power consumption of driver IC becomes the following by the above (1) to (3).

$$P_{Wtti}[W] = P_{Wa}[W] + P_{Wb}[W] + P_{Wc}[W]$$

$$\text{(ex.) } P_{Wtti}[W] = 10.0[mW] + 32.0[mW] + 0.5[mW] = 42.5[mW]$$

Operational Notes

1. Reverse Connection of Power Supply

Connecting the power supply in reverse polarity can damage the IC. Take precautions against reverse polarity when connecting the power supply, such as mounting an external diode between the power supply and the IC's power supply pins.

2. Power Supply Lines

Design the PCB layout pattern to provide low impedance supply lines. Separate the ground and supply lines of the digital and analog blocks to prevent noise in the ground and supply lines of the digital block from affecting the analog block. Furthermore, connect a capacitor to ground at all power supply pins. Consider the effect of temperature and aging on the capacitance value when using electrolytic capacitors.

3. Ground Voltage

Ensure that no pins are at a voltage below that of the ground pin at any time, even during transient condition. However, pins that drive inductive loads (e.g. motor driver outputs, DC-DC converter outputs) may inevitably go below ground due to back EMF or electromotive force. In such cases, the user should make sure that such voltages going below ground will not cause the IC and the system to malfunction by examining carefully all relevant factors and conditions such as motor characteristics, supply voltage, operating frequency and PCB wiring to name a few.

4. Ground Wiring Pattern

When using both small-signal and large-current ground traces, the two ground traces should be routed separately but connected to a single ground at the reference point of the application board to avoid fluctuations in the small-signal ground caused by large currents. Also ensure that the ground traces of external components do not cause variations on the ground voltage. The ground lines must be as short and thick as possible to reduce line impedance.

5. Thermal Consideration

Should by any chance the maximum junction temperature rating be exceeded the rise in temperature of the chip may result in deterioration of the properties of the chip. In case of exceeding this absolute maximum rating, increase the board size and copper area to prevent exceeding the maximum junction temperature rating.

6. Recommended Operating Conditions

These conditions represent a range within which the expected characteristics of the IC can be approximately obtained. The electrical characteristics are guaranteed under the conditions of each parameter.

7. Inrush Current

When power is first supplied to the IC, it is possible that the internal logic may be unstable and inrush current may flow instantaneously due to the internal powering sequence and delays, especially if the IC has more than one power supply. Therefore, give special consideration to power coupling capacitance, power wiring, width of ground wiring, and routing of connections.

8. Operation Under Strong Electromagnetic Field

Operating the IC in the presence of a strong electromagnetic field may cause the IC to malfunction.

9. Testing on Application Boards

When testing the IC on an application board, connecting a capacitor directly to a low-impedance output pin may subject the IC to stress. Always discharge capacitors completely after each process or step. The IC's power supply should always be turned off completely before connecting or removing it from the test setup during the inspection process. To prevent damage from static discharge, ground the IC during assembly and use similar precautions during transport and storage.

10. Inter-pin Short and Mounting Errors

Ensure that the direction and position are correct when mounting the IC on the PCB. Incorrect mounting may result in damaging the IC. Avoid nearby pins being shorted to each other especially to ground, power supply and output pin. Inter-pin shorts could be due to many reasons such as metal particles, water droplets (in very humid environment) and unintentional solder bridge deposited in between pins during assembly to name a few.

11. Unused Input Pins

Input pins of an IC are often connected to the gate of a MOS transistor. The gate has extremely high impedance and extremely low capacitance. If left unconnected, the electric field from the outside can easily charge it. The small charge acquired in this way is enough to produce a significant effect on the conduction through the transistor and cause unexpected operation of the IC. So unless otherwise specified, unused input pins should be connected to the power supply or ground line.

Operational Notes – continued

12. Regarding the Input Pin of the IC

In the construction of this IC, P-N junctions are inevitably formed creating parasitic diodes or transistors. The operation of these parasitic elements can result in mutual interference among circuits, operational faults, or physical damage. Therefore, conditions which cause these parasitic elements to operate, such as applying a voltage to an input pin lower than the ground voltage should be avoided. Furthermore, do not apply a voltage to the input pins when no power supply voltage is applied to the IC. Even if the power supply voltage is applied, make sure that the input pins have voltages within the values specified in the electrical characteristics of this IC.

13. Ceramic Capacitor

When using a ceramic capacitor, determine the dielectric constant considering the change of capacitance with temperature and the decrease in nominal capacitance due to DC bias and others.

14. Area of Safe Operation (ASO)

Operate the IC such that the output voltage, output current, and power dissipation are all within the Area of Safe Operation (ASO).

15. Thermal Shutdown Circuit(TSD)

This IC has a built-in thermal shutdown circuit that prevents heat damage to the IC. Normal operation should always be within the IC's power dissipation rating. If however the rating is exceeded for a continued period, the junction temperature (Tj) will rise which will activate the TSD circuit that will turn OFF all output pins. When the Tj falls below the TSD threshold, the circuits are automatically restored to normal operation.

Note that the TSD circuit operates in a situation that exceeds the absolute maximum ratings and therefore, under no circumstances, should the TSD circuit be used in a set design or for any purpose other than protecting the IC from heat damage.

Ordering Information

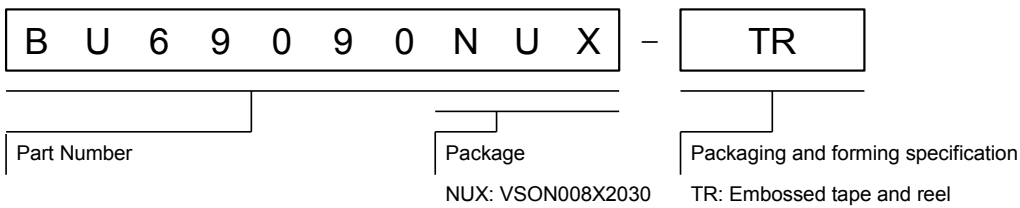

Marking Diagrams

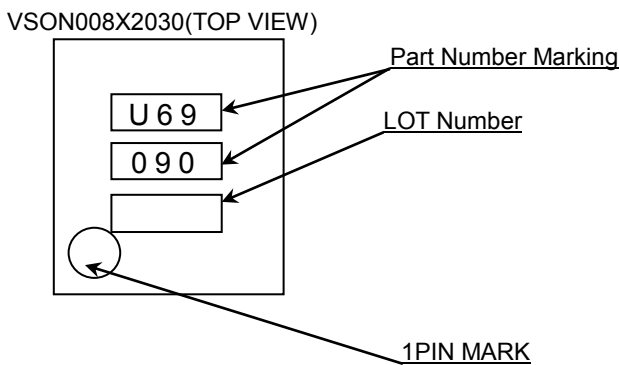

Physical Dimension Tape and Reel Information

Package Name	VSON008X2030
--------------	--------------

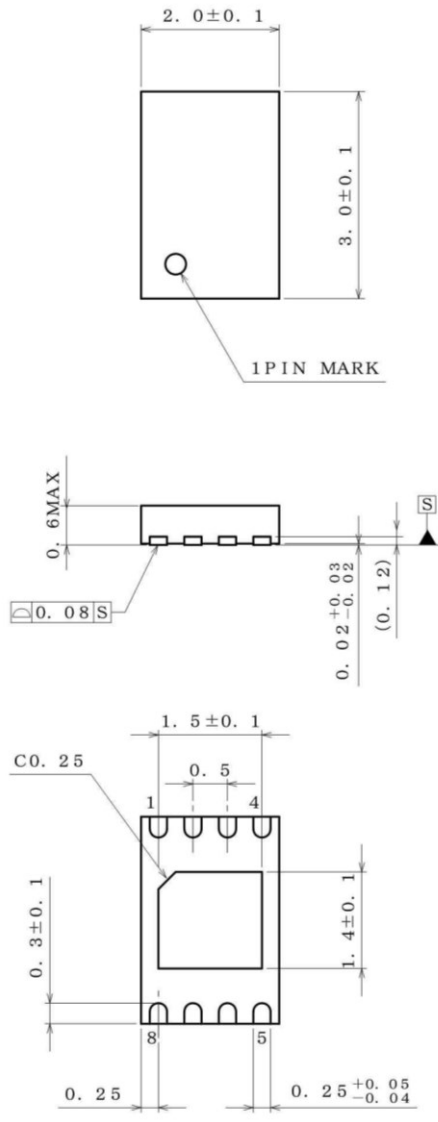

(UNIT : mm)
 PKG : VSON008X2030
 Drawing No. EX187-5001

<Tape and Reel information>

Tape	Embossed carrier tape
Quantity	4000pcs
Direction of feed	TR (The direction is the 1pin of product is at the upper right when you hold reel on the left hand and you pull out the tape on the right hand)

Revision History

Date	Revision	Changes
06.Dec.2016	001	New Release

Notice

Precaution on using ROHM Products

- Our Products are designed and manufactured for application in ordinary electronic equipments (such as AV equipment, OA equipment, telecommunication equipment, home electronic appliances, amusement equipment, etc.). If you intend to use our Products in devices requiring extremely high reliability (such as medical equipment ^(Note 1), transport equipment, traffic equipment, aircraft/spacecraft, nuclear power controllers, fuel controllers, car equipment including car accessories, safety devices, etc.) and whose malfunction or failure may cause loss of human life, bodily injury or serious damage to property ("Specific Applications"), please consult with the ROHM sales representative in advance. Unless otherwise agreed in writing by ROHM in advance, ROHM shall not be in any way responsible or liable for any damages, expenses or losses incurred by you or third parties arising from the use of any ROHM's Products for Specific Applications.

(Note1) Medical Equipment Classification of the Specific Applications

JAPAN	USA	EU	CHINA
CLASS III	CLASS III	CLASS II b	CLASS III
CLASS IV		CLASS III	

- ROHM designs and manufactures its Products subject to strict quality control system. However, semiconductor products can fail or malfunction at a certain rate. Please be sure to implement, at your own responsibilities, adequate safety measures including but not limited to fail-safe design against the physical injury, damage to any property, which a failure or malfunction of our Products may cause. The following are examples of safety measures:
 - Installation of protection circuits or other protective devices to improve system safety
 - Installation of redundant circuits to reduce the impact of single or multiple circuit failure
- Our Products are designed and manufactured for use under standard conditions and not under any special or extraordinary environments or conditions, as exemplified below. Accordingly, ROHM shall not be in any way responsible or liable for any damages, expenses or losses arising from the use of any ROHM's Products under any special or extraordinary environments or conditions. If you intend to use our Products under any special or extraordinary environments or conditions (as exemplified below), your independent verification and confirmation of product performance, reliability, etc. prior to use, must be necessary:
 - Use of our Products in any types of liquid, including water, oils, chemicals, and organic solvents
 - Use of our Products outdoors or in places where the Products are exposed to direct sunlight or dust
 - Use of our Products in places where the Products are exposed to sea wind or corrosive gases, including Cl₂, H₂S, NH₃, SO₂, and NO₂
 - Use of our Products in places where the Products are exposed to static electricity or electromagnetic waves
 - Use of our Products in proximity to heat-producing components, plastic cords, or other flammable items
 - Sealing or coating our Products with resin or other coating materials
 - Use of our Products without cleaning residue of flux (even if you use no-clean type fluxes, cleaning residue of flux is recommended); or Washing our Products by using water or water-soluble cleaning agents for cleaning residue after soldering
 - Use of the Products in places subject to dew condensation
- The Products are not subject to radiation-proof design.
- Please verify and confirm characteristics of the final or mounted products in using the Products.
- In particular, if a transient load (a large amount of load applied in a short period of time, such as pulse. is applied, confirmation of performance characteristics after on-board mounting is strongly recommended. Avoid applying power exceeding normal rated power; exceeding the power rating under steady-state loading condition may negatively affect product performance and reliability.
- De-rate Power Dissipation depending on ambient temperature. When used in sealed area, confirm that it is the use in the range that does not exceed the maximum junction temperature.
- Confirm that operation temperature is within the specified range described in the product specification.
- ROHM shall not be in any way responsible or liable for failure induced under deviant condition from what is defined in this document.

Precaution for Mounting / Circuit board design

- When a highly active halogenous (chlorine, bromine, etc.) flux is used, the residue of flux may negatively affect product performance and reliability.
- In principle, the reflow soldering method must be used on a surface-mount products, the flow soldering method must be used on a through hole mount products. If the flow soldering method is preferred on a surface-mount products, please consult with the ROHM representative in advance.

For details, please refer to ROHM Mounting specification

Precautions Regarding Application Examples and External Circuits

1. If change is made to the constant of an external circuit, please allow a sufficient margin considering variations of the characteristics of the Products and external components, including transient characteristics, as well as static characteristics.
2. You agree that application notes, reference designs, and associated data and information contained in this document are presented only as guidance for Products use. Therefore, in case you use such information, you are solely responsible for it and you must exercise your own independent verification and judgment in the use of such information contained in this document. ROHM shall not be in any way responsible or liable for any damages, expenses or losses incurred by you or third parties arising from the use of such information.

Precaution for Electrostatic

This Product is electrostatic sensitive product, which may be damaged due to electrostatic discharge. Please take proper caution in your manufacturing process and storage so that voltage exceeding the Products maximum rating will not be applied to Products. Please take special care under dry condition (e.g. Grounding of human body / equipment / solder iron, isolation from charged objects, setting of Ionizer, friction prevention and temperature / humidity control).

Precaution for Storage / Transportation

1. Product performance and soldered connections may deteriorate if the Products are stored in the places where:
 - [a] the Products are exposed to sea winds or corrosive gases, including Cl₂, H₂S, NH₃, SO₂, and NO₂
 - [b] the temperature or humidity exceeds those recommended by ROHM
 - [c] the Products are exposed to direct sunshine or condensation
 - [d] the Products are exposed to high Electrostatic
2. Even under ROHM recommended storage condition, solderability of products out of recommended storage time period may be degraded. It is strongly recommended to confirm solderability before using Products of which storage time is exceeding the recommended storage time period.
3. Store / transport cartons in the correct direction, which is indicated on a carton with a symbol. Otherwise bent leads may occur due to excessive stress applied when dropping of a carton.
4. Use Products within the specified time after opening a humidity barrier bag. Baking is required before using Products of which storage time is exceeding the recommended storage time period.

Precaution for Product Label

A two-dimensional barcode printed on ROHM Products label is for ROHM's internal use only.

Precaution for Disposition

When disposing Products please dispose them properly using an authorized industry waste company.

Precaution for Foreign Exchange and Foreign Trade act

Since concerned goods might be fallen under listed items of export control prescribed by Foreign exchange and Foreign trade act, please consult with ROHM in case of export.

Precaution Regarding Intellectual Property Rights

1. All information and data including but not limited to application example contained in this document is for reference only. ROHM does not warrant that foregoing information or data will not infringe any intellectual property rights or any other rights of any third party regarding such information or data.
2. ROHM shall not have any obligations where the claims, actions or demands arising from the combination of the Products with other articles such as components, circuits, systems or external equipment (including software).
3. No license, expressly or implied, is granted hereby under any intellectual property rights or other rights of ROHM or any third parties with respect to the Products or the information contained in this document. Provided, however, that ROHM will not assert its intellectual property rights or other rights against you or your customers to the extent necessary to manufacture or sell products containing the Products, subject to the terms and conditions herein.

Other Precaution

1. This document may not be reprinted or reproduced, in whole or in part, without prior written consent of ROHM.
2. The Products may not be disassembled, converted, modified, reproduced or otherwise changed without prior written consent of ROHM.
3. In no event shall you use in any way whatsoever the Products and the related technical information contained in the Products or this document for any military purposes, including but not limited to, the development of mass-destruction weapons.
4. The proper names of companies or products described in this document are trademarks or registered trademarks of ROHM, its affiliated companies or third parties.

General Precaution

1. Before you use our Products, you are requested to carefully read this document and fully understand its contents. ROHM shall not be in any way responsible or liable for failure, malfunction or accident arising from the use of any ROHM's Products against warning, caution or note contained in this document.
2. All information contained in this document is current as of the issuing date and subject to change without any prior notice. Before purchasing or using ROHM's Products, please confirm the latest information with a ROHM sales representative.
3. The information contained in this document is provided on an "as is" basis and ROHM does not warrant that all information contained in this document is accurate and/or error-free. ROHM shall not be in any way responsible or liable for any damages, expenses or losses incurred by you or third parties resulting from inaccuracy or errors of or concerning such information.