

PE-505 Pure Embedded 10/100 5 Port Industrial Ethernet Switch

1 Overview

The perfect fit for any stable, future-proof system, even where space is limited

- Stability of design guaranteed compatibility until at least 2034 (min. 10 years)
- Compact form – smaller than a standard business card (55x55x10mm)
- Seamless integration with design software - logical placements and fixed distances
- 3D CAD files and PCB footprints
- Board-to-board and board-to-cable connection
- LEDs visible in all orientations – option to route through fibre

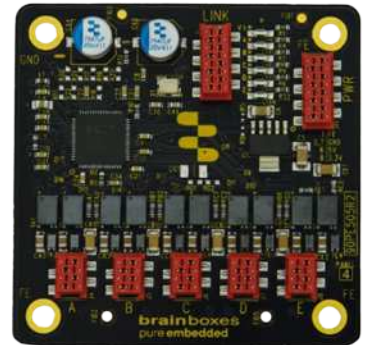

1.1 Functionality and Features

- 5 port 10/100Mbps switch (10BASE-T/100BASE-TX)
- 3.3 or 5 VDC Input
- Reverse Polarity Protected
- Transient Voltage Protected
- 1500V magnetic isolation between ports
- EMC testing information¹
- IEEE802.3az Energy Efficient Ethernet
- Auto MDI/MDIX
- Low power consumption
- Power and link indicators for all ports visible from all angles
- Board-to-board and wire-to-board compatible
- TE MicroMatch compatible connectors (Compatible with board-to-board and wire-to-board connections)
- Non-blocking layer 2 operation
- Extremely compact 55x55mm board size
- Full 2D and 3D CAD files available

Pure Embedded Tool Kit (resources include: schematic, DWF file, PCB footprint and 3D download)

Table 1, General Information

Voltage Input	3.3V or 5V DC
Maximum Power Consumption ²	1.3W @ 3.3V 2.5W @ 5V
Standard Compliance	IEEE 802.3az FCC Class A EN 55033 A
Operating Temperature	-40°C to +85°C / -40°F to +185°F
Storage Temperature	-40°C to +85°C / -40°F to +185°F
Size	55x55x10mm / 2.17x2.17x0.39in
Weight	40g / 0.09lbs

¹ For more detail check Manual Section 11

² For further detail check Manual Section 12

1.2 Connectors

The Board contains five 4-way female TE MicroMatch style connectors for Ethernet and two 8-way female TE MicroMatch style connectors for link and power.

Table 2, Male Header Compatibility

Number of Ways	Type	Manufacturer	Part Number
4-way	SMD	Wurth	690 357 280 476
		TE	338728-4
	THT	Wurth	690 357 100 472
		TE	215464-4
	Board to Wire	Wurth	690 157 000 472
			TE
338095-4			
8-way	SMD	Wurth	690 357 280 476
		TE	338728-8
	THT	Wurth	690 357 100 872
		TE	215464-8
	Board to Wire	Wurth	690 157 000 872
			TE
		338095-8	

Table 3, Connector Wiring Guide

Connector/PIN	1	2	3	4	5	6	7	8
Port A-E (RJ45 Pin)	RXD – Orange (Pin 6)	RXD + Orange/ White (Pin 3)	TXD – Green (Pin 2)	TXD + Green/ White (Pin 1)	N/A	N/A	N/A	N/A
LINK	Port A	Port B	Port C	Port D	Port E	LED Power	GND	Self-Test
PWR	FE	-	-	-	GND	VIN _{5V}	GND	VIN _{3.3V}

2 Ordering

Table 4, Ordering Information

Product Code	Description
PE-405	Pure Embedded 10/100 5 Port Industrial Ethernet Eval Kit
PE-505	Pure Embedded 10/100 5 Port Industrial Ethernet Switch
PE-205	Pure Embedded Dual Output Industrial Power Supply
PE-515	Pure Embedded 1G 5 Port Industrial Ethernet Switch
PE-415	Pure Embedded 1G 5 Port Industrial Ethernet Evaluation Kit

3 Changelog

Table 5, Changelog

Date	Revision	Author	Notes
03/2023	0.1	BH	Initial Release
07/2023	1.0	HR/LW	First Publication
08/2023	1.1	HR	Resources link added

Please check <https://www.brainboxes.com/product/pure-embedded/pe-505> for the most recent datasheet revision



4 Table of Contents

1	Overview	1
1.1	Functionality and Features	1
1.2	Connectors	2
2	Ordering	2
3	Changelog	2
4	Table of Contents	3
5	List of Tables	4
6	List of Figures	4
7	Product Variants	4
8	PE-405 Embedded Eval Kit	5
9	Design Guide	6
9.1	Connectors and pinouts	6
9.1.1	Ethernet Header (4 Pin)	6
9.1.2	Link LED Header (8 Pin)	7
9.1.3	Mounting Holes	7
9.2	2D Drawing	7
9.3	3D Step File	8
9.4	Recommended Footprint	8
9.5	Routing	9
10	Troubleshooting	10
10.1	Device Markings	10
10.2	Power Supply Verification	10
10.3	Self-Test Procedure	11
10.3.1	90PE505R2	11
11	EMC Report	12
11.1	Conducted Emissions	12
11.1.1	Emissions at 3.3V	12
11.1.2	Emissions at 5V	13
11.1.3	Emissions at 110V	14
11.1.4	Emissions at 230V	15
11.2	Radiated Emissions	16
11.2.1	Radiated Emissions (EN Limit)	16
11.2.2	Radiated Emissions (FCC Limit)	17
12	Operating Conditions	18
12.1	Absolute Maximum Ratings	18
12.2	Electrical Characteristics	18
13	Stability of design guarantee	19

5 List of Tables

Table 1, General Information.....	1
Table 2, Header Compatibility	2
Table 3, Connector Wiring Guide.....	2
Table 4, Ordering Information	2
Table 5, Changelog.....	2
Table 6, Absolute Maximum Ratings	18
Table 7, Typical Electrical Characteristics	18

6 List of Figures

Figure 1, 4 Pin Connector for 10/100 Ethernet (Red Wire Indicates Pin 1)	6
Figure 2, 8 Pin Power and LED Connector (Red Wire Indicates Pin 1)	7
Figure 3, External LED Wiring.....	7
Figure 4, 2D Drawing of PE205 Connector Locations.....	8
Figure 5, 3D Step File	8
Figure 4, PE-405 Evaluation Board Routing	9
Figure 5, Device Markings Outline	10
Figure 8, Power Header Debugging	10
Figure 9, Self Test Procedure	11

7 Product Variants

Product Code	Description
PE-405	Pure Embedded 10/100 5 Port Industrial Ethernet Eval Kit https://www.brainboxes.com/product/pure-embedded/pe-405
PE-505	Pure Embedded 10/100 5 Port Industrial Ethernet Switch https://www.brainboxes.com/product/pure-embedded/pe-505
PE-205	Pure Embedded Dual Output Industrial Power Supply https://www.brainboxes.com/product/pure-embedded/pe-205
PE-515	Pure Embedded 1G 5 Port Industrial Ethernet Switch https://www.brainboxes.com/product/pure-embedded/pe-515
PE-415	Pure Embedded 1G 5 Port Industrial Ethernet Evaluation Kit https://www.brainboxes.com/product/pure-embedded/pe-415

There are currently no alternative variants available for this product.

8 PE-405 Embedded Eval Kit

The [PE-405](#) allows for further testing and debugging within a prototype system before any commitment to custom fixtures or designs is made.

A reference design schematic of the eval kit is available to download from brainboxes website and include in your system.

- Quick easy access to all PE-505 functionality
- Simplifies integration into test systems

The mating board breaks out all ports and functionality to RJ45 or usable headers.

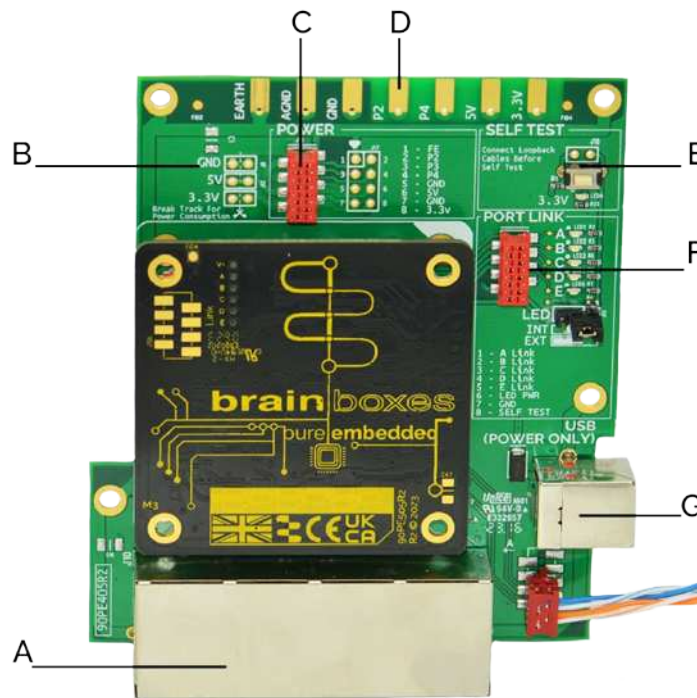

A <- 4xRJ45 and 1x MicroMatch Compatible 4 pin header

B <- Power Consumption Monitoring

C <- Power Header

D <- Croc clip Power points

E <- Self Test Button

F <- Link Header - 2 jumper selectable options:

1. Onboard LEDS
2. External LEDS (through header)

G <- USB Power

Allows easy access to all features of the PE-505 for evaluation and testing

Notes on Power consumption monitoring

3 tracks for monitoring power on 3.3V, 5V and GND power rails (Not compatible with USB supply)

the indicated tracks can be cut to allow monitoring of power consumption

9 Design Guide

9.1 Connectors and pinouts

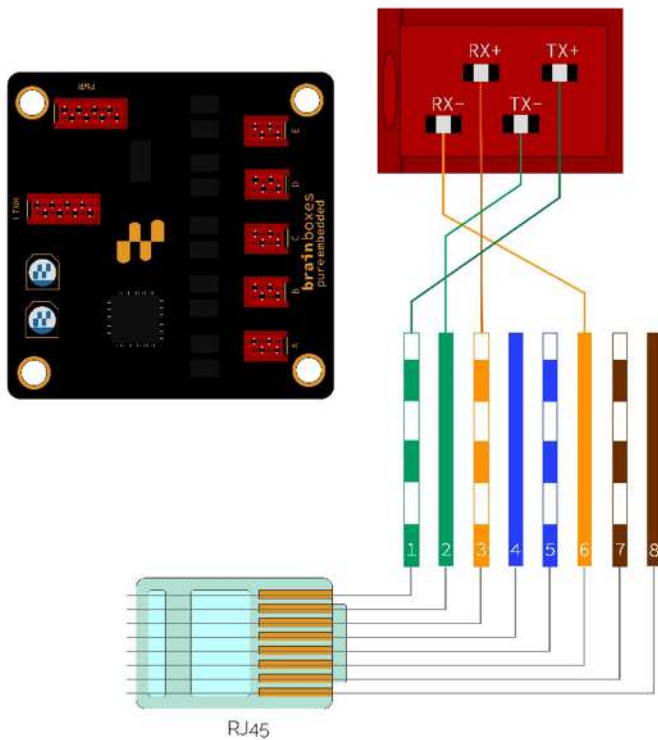

RJ45 Pin	100Base-T	1000Base-T
1	TX+	B+
2	TX-	B-
3	RX+	A+
4	n/c	C+
5	n/c	C-
6	RX-	A-
7	n/c	D+
8	n/c	D-

9.1.1 Ethernet Header (4 Pin)

As the PE-505 supports Auto MDI/MDIX the wiring of the RX and TX pins are reversible. Section 0 above details the recommended Pin configuration for the ethernet ports. Coloured Cat5 cable can be wired as shown. For Longer distances (>1.5m) using shielded cable is optimal. Shielding can be attached to the Functional Earth mounting points on the bottom corners of the board

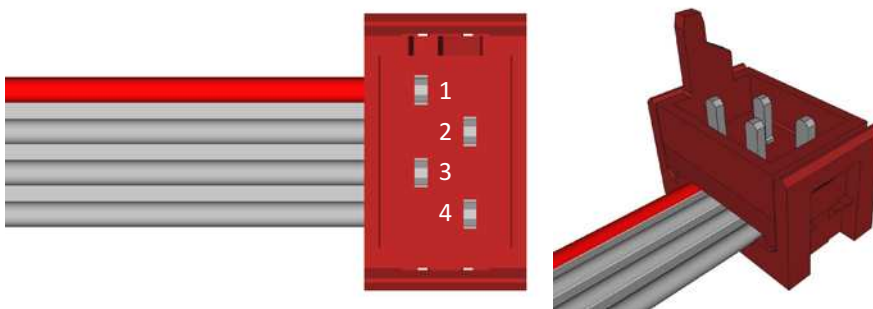

Figure 1, 4 Pin Connector for 10/100 Ethernet (Red Wire Indicates Pin 1)

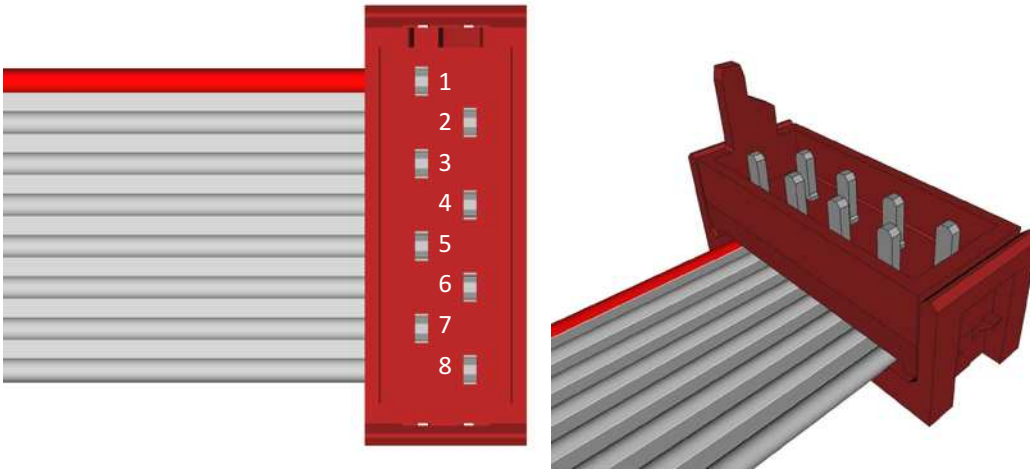

Figure 2, 8 Pin Power and LED Connector (Red Wire Indicates Pin 1)

9.1.2 Link LED Header (8 Pin)

Each port has a Link Indicator LED and a Link Indicator Output. The output current must be limited through a resistor. The resistor must be selected to limit the maximum draw to 20mA @ 3.3V. The LEDs must be powered from the LED Power Pin. The LEDs function in an active LOW configuration and should be connected as shown below in Figure 3. The Power draw of any supplementary LEDs is in addition to the specified power on the datasheet. Should it be impractical to implement an Electronic based Link LED forwarding. There are holes of $\varnothing 1\text{mm}$ under each of the indication LEDs suitable for housing optical fibres or light pipes of a length less than 50cm.

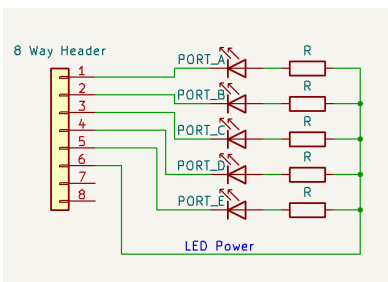

Figure 3, External LED Wiring

9.1.3 Mounting Holes

The 4 x M3 mounting holes are Connected to Functional Earth (FE) or Ground (GND) and labelled accordingly. (See Section 10.1

Figure 7) If the device does not share a common ground with the rest of the system it is recommended to use a nonconductive standoff or isolated mounting point.

9.2 2D Drawing

Scale drawings available to download on the Brainboxes website

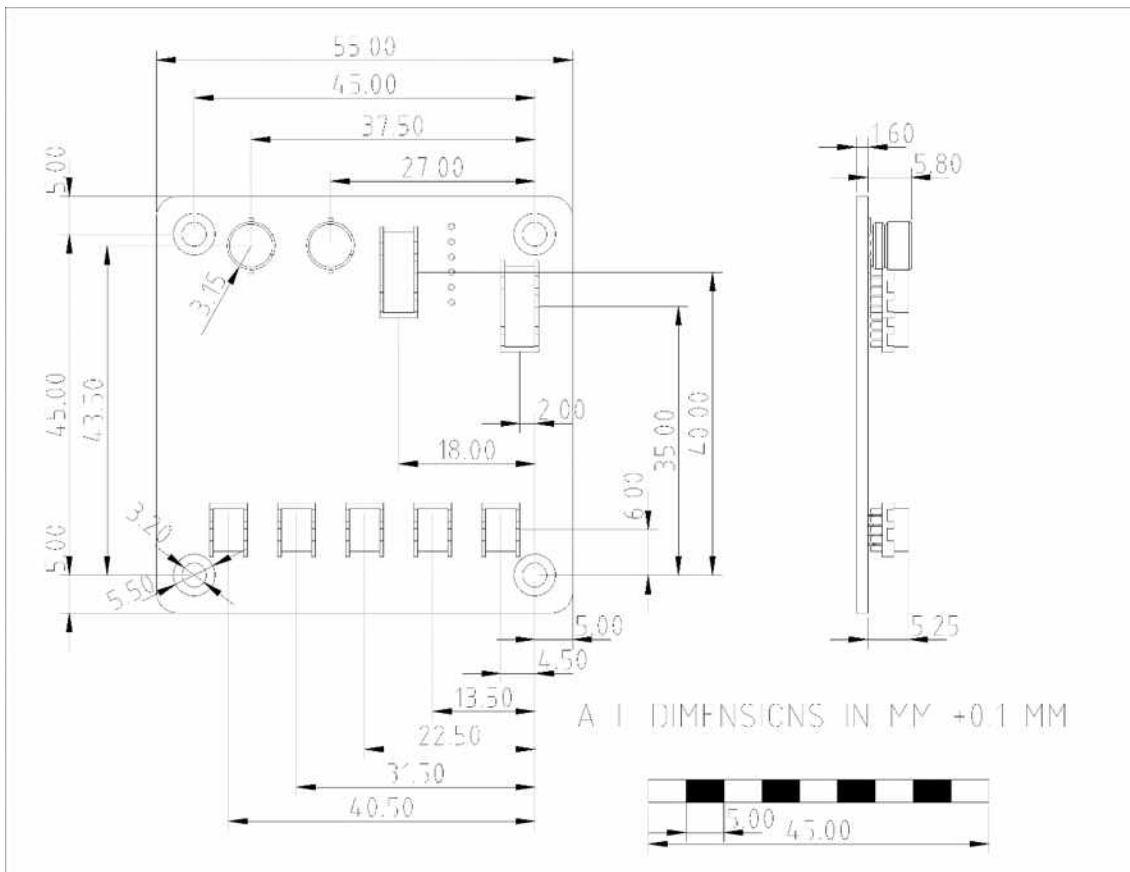

Figure 4, 2D Drawing of PE205 Connector Locations 1:1 Scale at A4

9.3 3D Step File

The full 3D model can be downloaded from the Brainboxes website

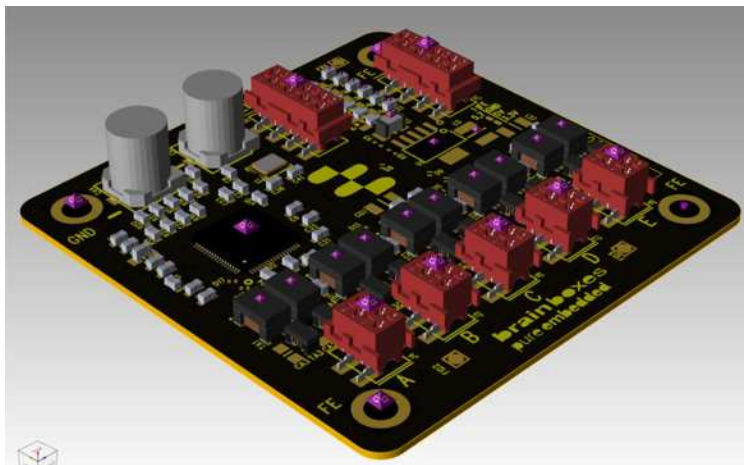

Figure 5, 3D Step File

9.4 Recommended Footprint

The mating LED Header and Port Header are not essential and can be excluded if not required. For applications where the module is frequently inserted and removed, we recommend using through hole mating connectors. Avoid placing components within the 55x55 square occupied by the PE-505. The device should be given 12mm of clearance from the mating surface.

Recommended footprint downloaded from the Brainboxes website:

An array of 4 way headers with coordinates of (4.5,6),(13.5,6),(22.5,6),(31.5,6),(40.5,6)

2 x 8 way headers with the center locations (2,35.5),(18,40)

4 x M3 mounting holes at (0,0), (45,0), (0,45) and (45,45)(GND)

Either Through Hole or SMT headers can be used as per the part numbers detailed in Section 0

9.5 Routing

When designing custom boards for the PE-505 it is important to take into consideration routing the device to connectors across a board.

Routing Recommendations:

- Keep Pairs at Uniform distance
- Keep Pairs at as close length as possible.
- Place a GND plane between different pairs
- Ensure Pairs do not cross plane boundaries
- For more information we recommend reading:
 1. Microchip AN2054 (Ethernet Differential Pairs)
 2. Texas Instruments SNLA387 (Ethernet PHY PCB Design Layout Checklist)

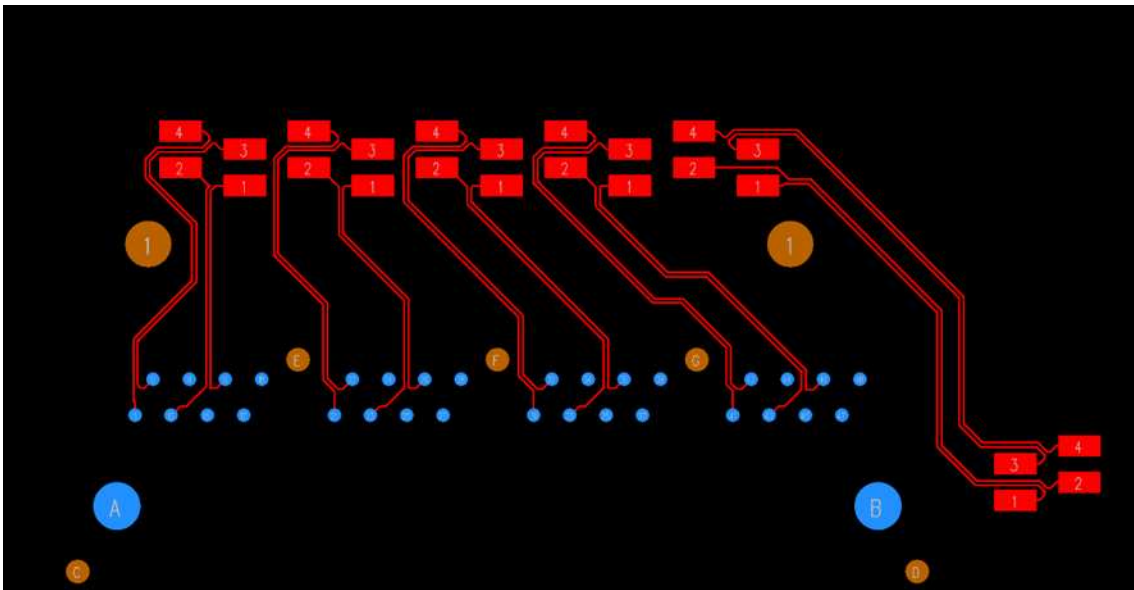

Figure 6, PE-405 Evaluation Board Routing

10 Troubleshooting

10.1 Device Markings

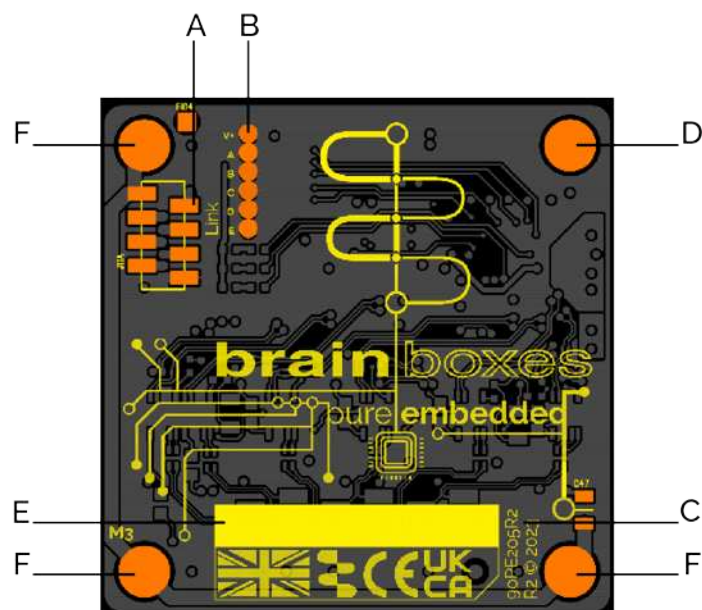

Figure 7, Device Markings Outline

Markings on the rear of this device are subject to change. This will not affect the functionality of the device.

A <- Debug Header (See 10.2 below)

B <- LED Status Indicators

C <- 90PE505R2 <- PCB Revision and release year.

D <- GND Mounting Hole

E <- Product variant, Serial Number and Date of Manufacture

F <- FE Mounting Holes

10.2 Power Supply Verification

There are several Pads on the reverse of the board, these can be used to diagnose issues with power delivery. The Voltage on pads V_{in} and $V_{3.3}$ must be within tolerances defined in Table 7.

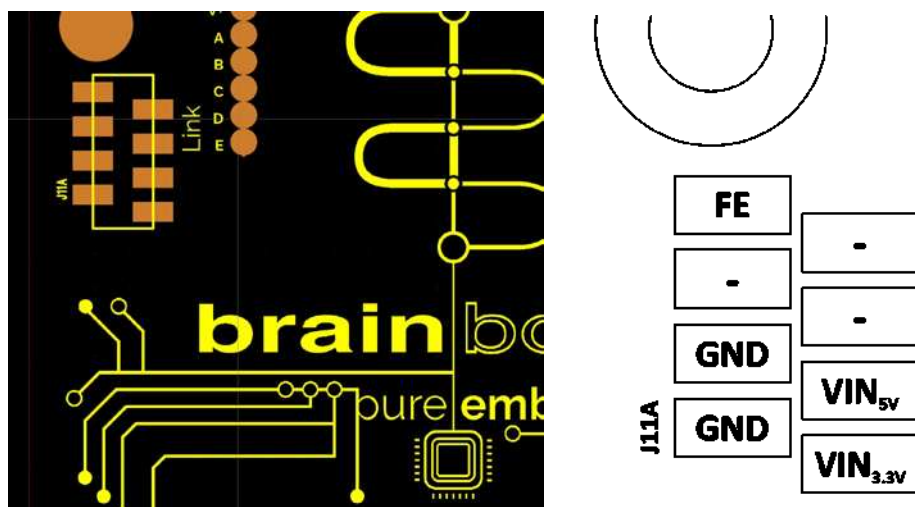

Figure 8, Power Header Debugging

10.3 Self-Test Procedure

Check Section 10.1 above to determine device revision. If your revision is not included here check the Brainboxes website for the Updated datasheet.

10.3.1 90PE505R2

The PE-505 Implements a self-test facility to test each port is operating correctly. Each should be connected to a self-loopback. We recommend using a PE-405 Eval Kit for this purpose.

Procedure

1. Connect Pin 1 to Pin 3 and Pin 2 to Pin 4 for each of the 5 Ports (RX+ to TX+ and RX- to TX-)
2. Connect a push Button between Pin 6 and Pin 8 of the LINK status connector
3. Power the device on
4. Press the test button
5. Wait 5 seconds and press the test button again
6. Ports which pass the Loopback test should Light their link LED

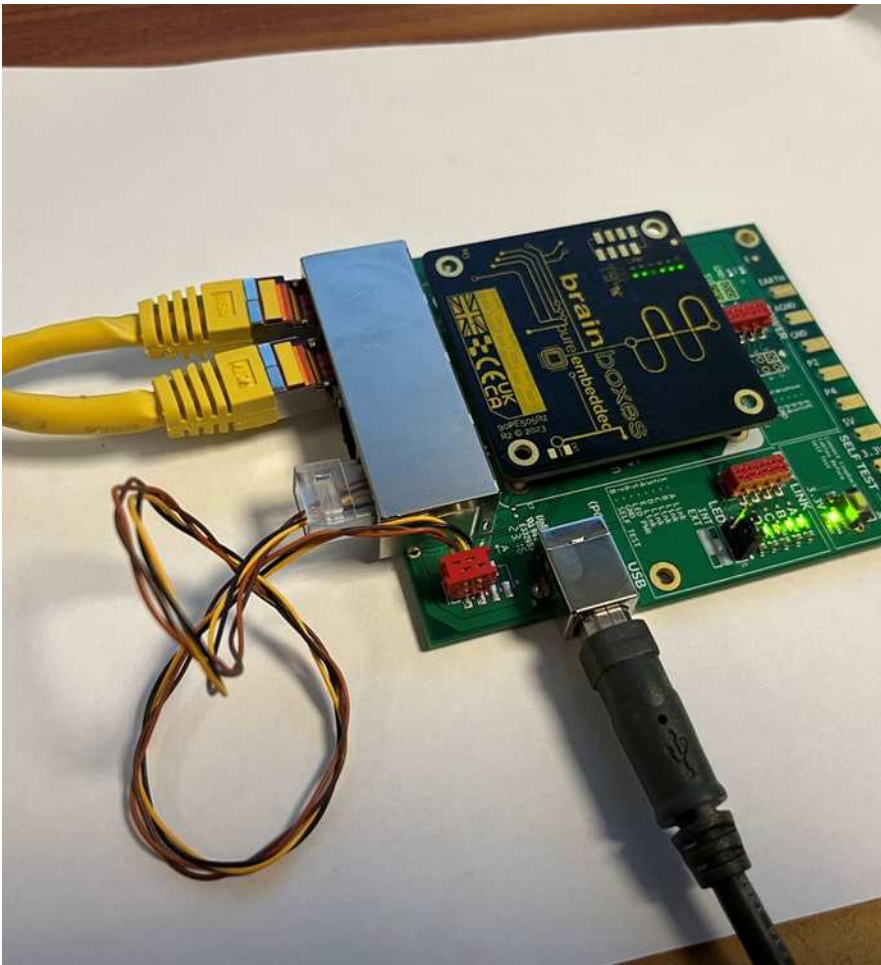

Figure 9, Self-Test Procedure

11 EMC Report

The device has been tested in a fully stressed typical application with the PE405 Eval Kit. The device has been proven to meet and exceed both FCC Part 15 and EN55032 emissions standards at minimum of class A.

11.1 Conducted Emissions

The Device Exceeds Class B emission standards for both the FCC and EN conducted emissions by a satisfactory margin. The test results below show the

11.1.1 Emissions at 3.3V

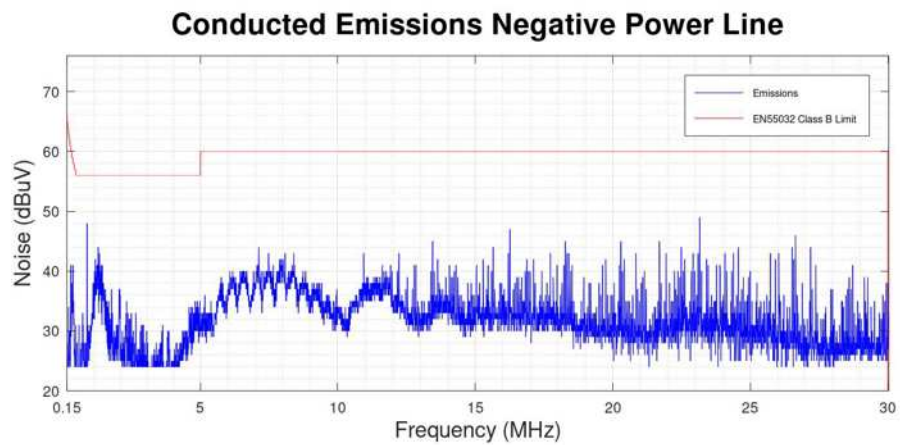
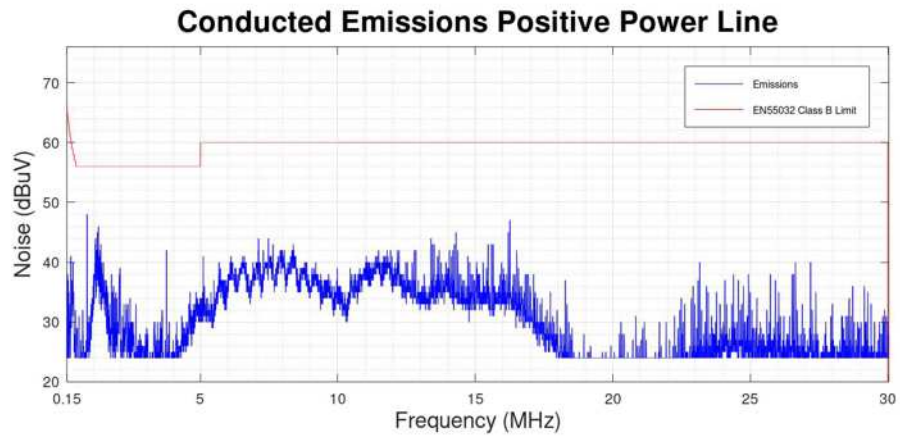

11.1.2 Emissions at 5V

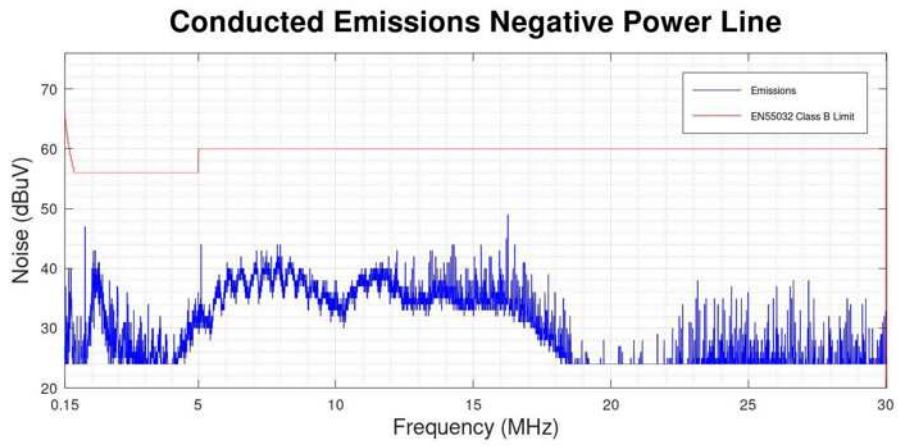
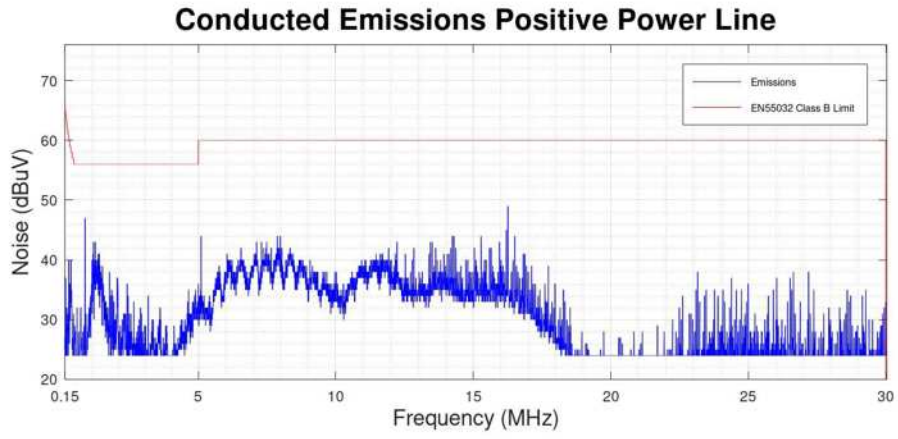

11.1.3 Emissions at 110V

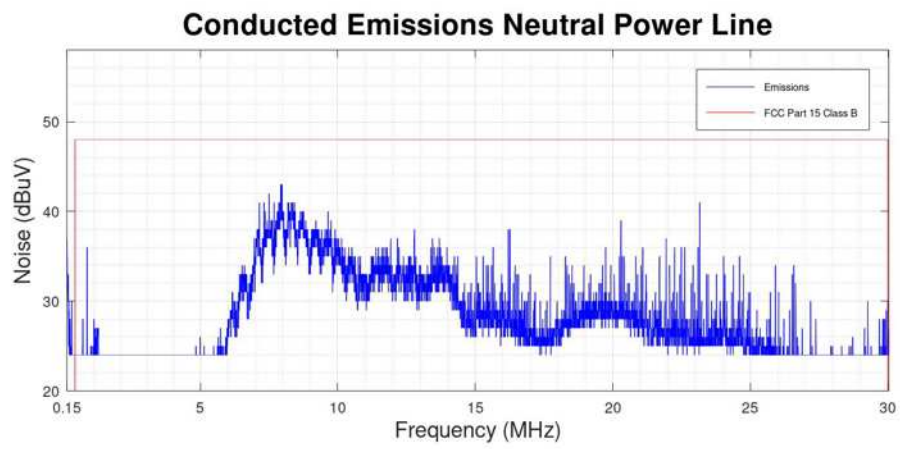
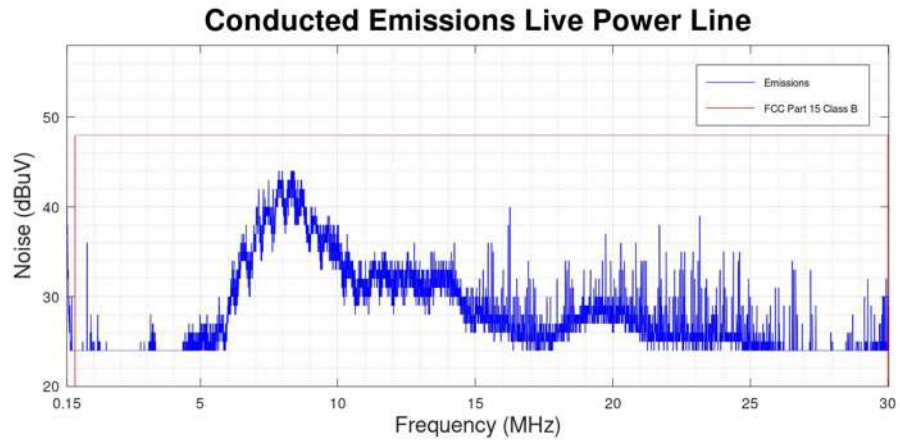

11.1.4 Emissions at 230V

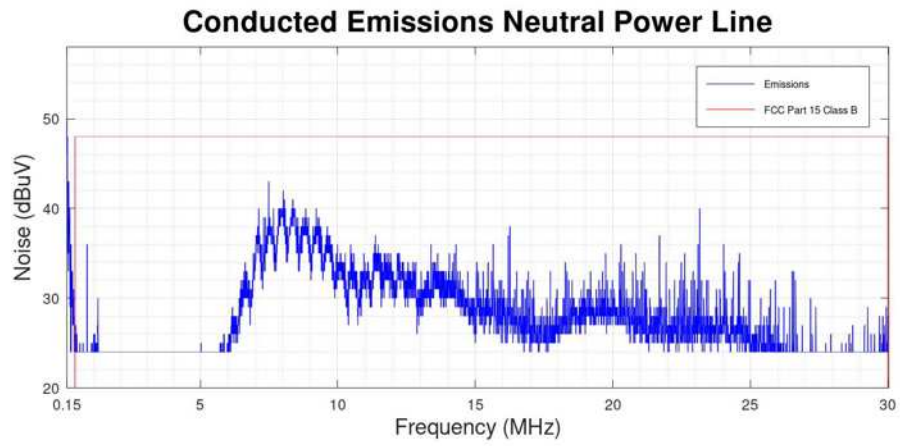
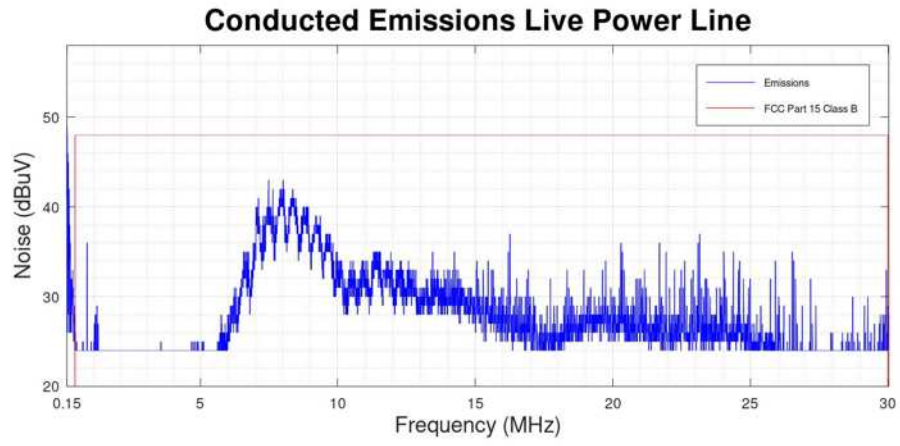

11.2 Radiated Emissions

The device Comfortably meets the Class A Emission standards for both FCC and EN radiated emissions.

11.2.1 Radiated Emissions (EN Limit)

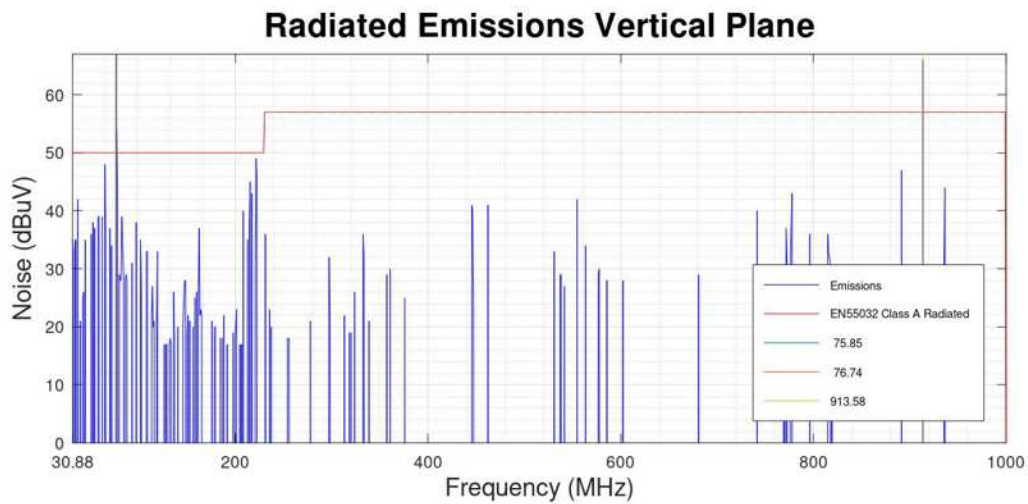
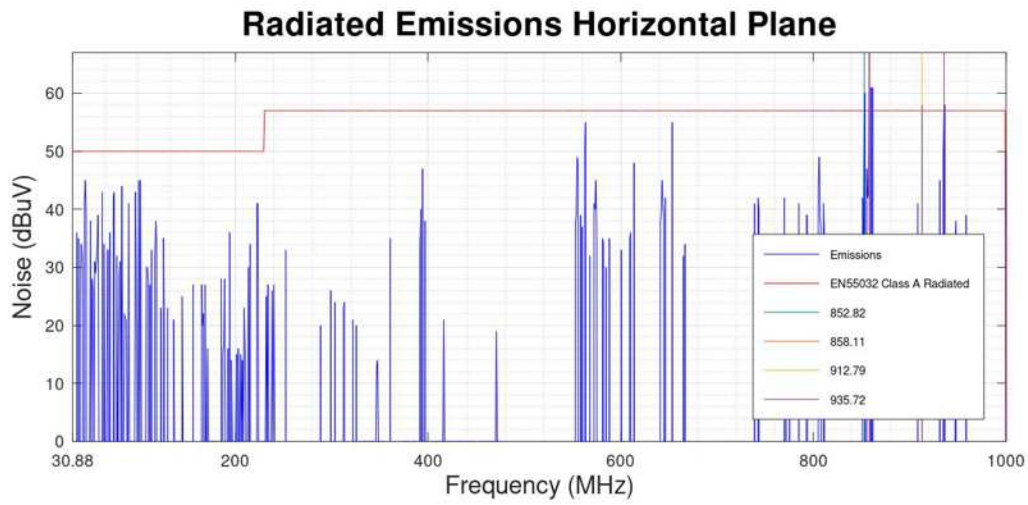

11.2.2 Radiated Emissions (FCC Limit)

Radiated Emissions Horizontal Plane

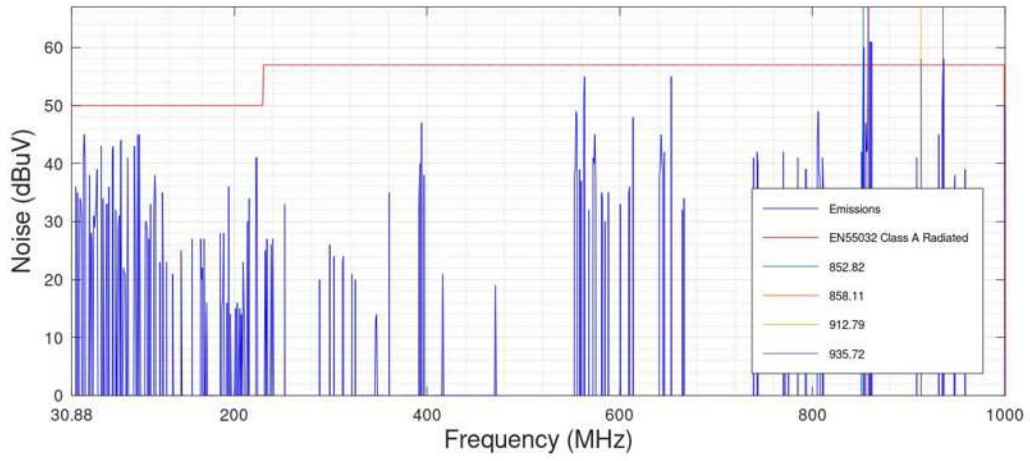

Radiated Emissions Vertical Plane

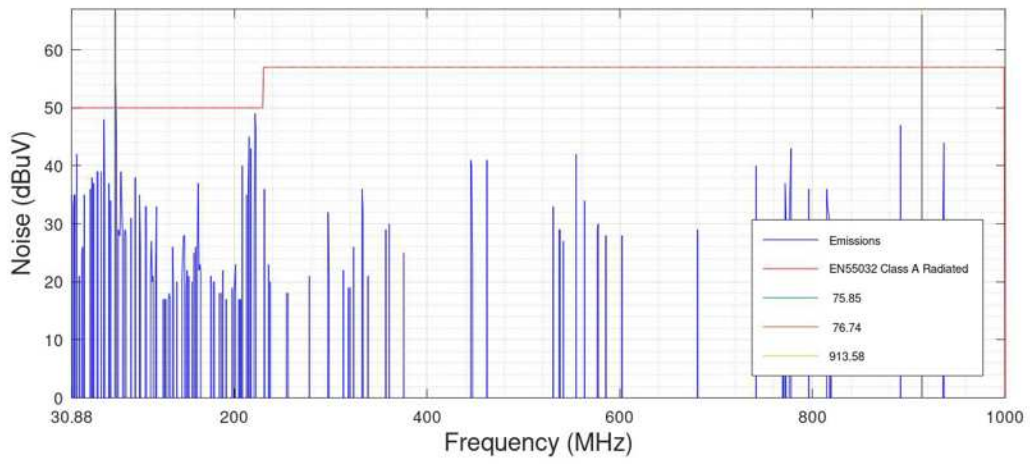

12 Operating Conditions

12.1 Absolute Maximum Ratings

Stresses exceeding absolute maximum ratings may cause permanent damage. Functional performance and device reliability are not guaranteed under these conditions. All voltages are specified with respect to GND.

Table 6, Absolute Maximum Ratings

Parameter	Max	Unit	Notes
Direct Supply Voltage	3.63	V	
Supply Voltage	7.5	V	
Ambient Operating Temperature	- 40 to 85	°C	

12.2 Electrical Characteristics

Table 7, Typical Electrical Characteristics

Parameter	Symbol	Min	Typical	Max	Unit	Notes
Supply Voltage		3.15	3.3	3.45	V	
3.3V Direct Supply Power Consumption ³	P _{100MF}		1.3		W	All port link 100Mbps Fully active
	P _{10MF}		1.2			All port link 10Mbps Fully active
	P _{IDLE}		0.3			All port unlink
Supply Voltage		4.5	5	6	V	
5V Supply Power Consumption ⁴	P _{100MF}	1.7		2.3	W	All port link 100Mbps Fully active
	P _{10MF}	1.6		2.2		All port link 10Mbps Fully active
	P _{IDLE}	0.35		0.5		All port unlink
LED Output Low	LED On	0		0.345	V	
LED Output High	LED Off	2.52		3.45	V	
Startup time	T _{startup}			100ms		

³ Specified Power Consumption Excludes load attached to the LINK LED header

⁴ Specified Power Consumption Excludes load attached to the LINK LED header

13 Stability of design guarantee

Brainboxes has a Product Change Control Policy here: <https://www.brainboxes.com/regulatory-declarations>