



DECLARACIÓN DE PRESTACIONES



no 0002 – ES

1. Código de identificación única del producto tipo: **fischer SXRL 14**

2. Usos previstos:

producto	Uso/s previsto/s
Anclajes de plástico para el uso en hormigón y mampostería	para aplicación en sistemas, tales como fachadas, para la fijación o anclaje de elementos que contribuyan a la estabilidad de los sistemas, Véase el apéndice, especialmente los anexos B 1 - B 4

3. Fabricante: **fischerwerke GmbH & Co. KG, Klaus-Fischer-Straße 1, 72178 Waldachtal, Germany**

4. Representante autorizado: --

5. Sistemas de evaluación y verificación de la constancia de las prestaciones (EVCP): **2+**

6a. Norma armonizada: ---

Organismos notificados: ---

6b. Documento de evaluación europeo: **ETAG 020; 2012-03**

Evaluación técnica europea: **ETA-14/0297; 2014-09-05**

Organismo de evaluación técnica: **DIBt**

Organismos notificados: **1343 – MPA Darmstadt**

7. Prestaciones declaradas:

protección contra incendios (BWR 2)

indicación esencial	Prestaciones
Reacción al fuego	el anclaje cumple con las exigencias de la clase A1.
resistencia al fuego	Ver anexo, especialmente anexo C 1

seguridad y accesibilidad en la aplicación (BWR 4)

indicación esencial	Prestaciones
valores característicos para solicitaciones a tracción y a cortante	Ver anexo, especialmente anexo C 1 – C 4
momentos flectores característicos	Ver anexo, especialmente anexo C 1
desplazamientos bajo solicitaciones a tracción y a cortante	Ver anexo, especialmente anexo C 1 + C 4
distancias entre anclajes y dimensiones de la base de anclaje	Ver anexo, especialmente anexo B 2 – B 3

8. Documentación técnica adecuada o documentación técnica específica: ---

Las prestaciones del producto identificado anteriormente son conformes con el conjunto de prestaciones declaradas. La presente declaración de prestaciones se emite, de conformidad con el Reglamento (UE) no 305/2011, bajo la sola responsabilidad del fabricante arriba identificado.

Firmado por y en nombre del fabricante por:

Andreas Bucher, Dipl.-Ing.

Wolfgang Hengesbach, Dipl.-Ing., Dipl.-Wirtsch.-Ing.

Tumlingen, 2015-02-03

- Este DoP ha sido redactado en varios idiomas. En caso de disputa acerca de la interpretación siempre prevalecerá la versión en inglés.

- el anexo contiene información voluntaria y complementaria en inglés, que va más allá de las exigencias legales.

Specific Part

Technical description of the product

- 1** The fischer frame fixing SXRL 14 is a plastic anchor consisting of a plastic sleeve made of polyamide and an accompanying specific screw of galvanised steel with an additional Duplex-coating or of stainless steel
- The plastic sleeve is expanded by screwing in the specific screw which presses the sleeve against the wall of the drilled hole.
- The product description is given in Annex A.

2 **Specification of the intended use in accordance with the applicable European Assessment Document**

The performances given in Section 3 are only valid if the anchor is used in compliance with the specifications and conditions given in Annex B.

The verifications and assessment methods on which this European Technical Assessment is based lead to the assumption of a working life of the anchors of at least 50 years. The indications given on the working life cannot be interpreted as a guarantee given by the producer, but are to be regarded only as a means for choosing the right products in relation to the expected economically reasonable working life of the works.

3 **Performance of the product and references to the methods used for its assessment**

3.1 **Mechanical resistance and stability (BWR 1)**

The essential characteristics regarding mechanical resistance and stability are included under the Basic Works Requirement Safety in use.

3.2 **Safety in case of fire (BWR 2)**

Essential characteristic	Performance
Reaction to fire	Anchorage satisfy requirements for Class A 1
Resistance to fire	See Annex C 1

3.3 **Hygiene, health and the environment (BWR 3)**

Not applicable

3.4 **Safety and accessibility (BWR 4)**

Essential characteristic	Performance
Characteristic resistance for tension and shear loads	See Annex C 1 – C 4
Characteristic resistance for bending moments	See Annex C 1
Displacements under shear and tension loads	See Annex C 1 + C 4
Anchor distances and dimensions of members	See Annex B 2 – B 3

3.5 Protection against noise (BWR 5)

Not applicable

3.6 Energy economy and heat retention (BWR 6)

Not applicable

3.7 Sustainable use of natural resources (BWR 7)

The sustainable use of natural resources was not investigated.

3.8 General aspects

The verification of durability is part of testing the essential characteristics. Durability is only ensured if the specifications of intended use according to Annex B are taken into account.

4 Assessment and verification of constancy of performance (AVCP) system applied, with reference to its legal base

According to Decision 97/463/EC of the Commission of 27 June 1997 (Official Journal of the European Communities L 198 of 25.07.1997, p. 31–32) the system of assessment and verification of constancy of performance (AVCP) (see Annex V and Article 65 Paragraph 2 to Regulation (EU) No 305/2011) given in the following table applies.

Product	Intended use	Level or class	System
Plastic anchors for use in concrete and masonry	For use in systems, such as façade systems, for fixing or supporting elements which contribute to the stability of the systems	—	2+

SXRL 14

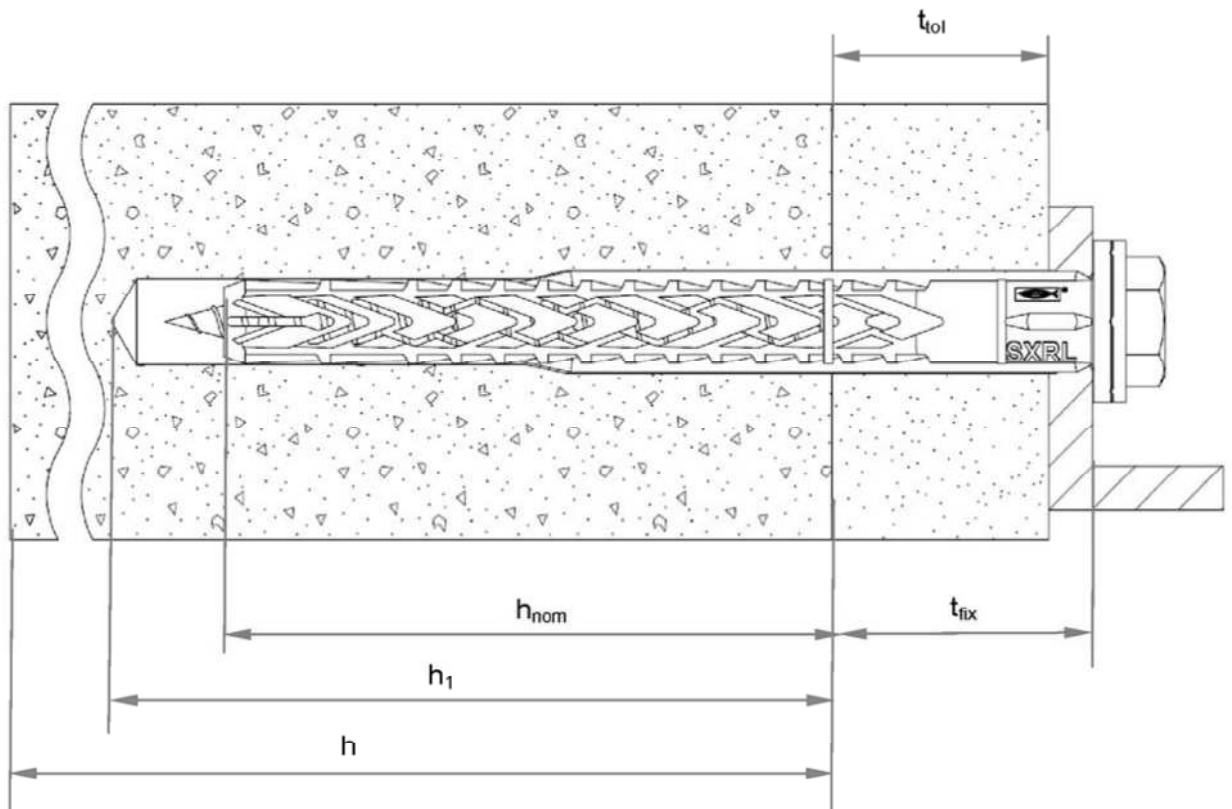

Legend

- h_{nom} = Overall plastic anchor embedment depth in the base material
- h_1 = Depth of drilled hole to deepest point
- h = Thickness of member
- t_{tol} = Thickness of equalizing layer or non-load bearing coating
- t_{fix} = Thickness of fixture + t_{tol}

SXRL 14	Annex A 1
Product description Installed anchor	

Anchor sleeves – flat collar version for FUS screw of SXRL

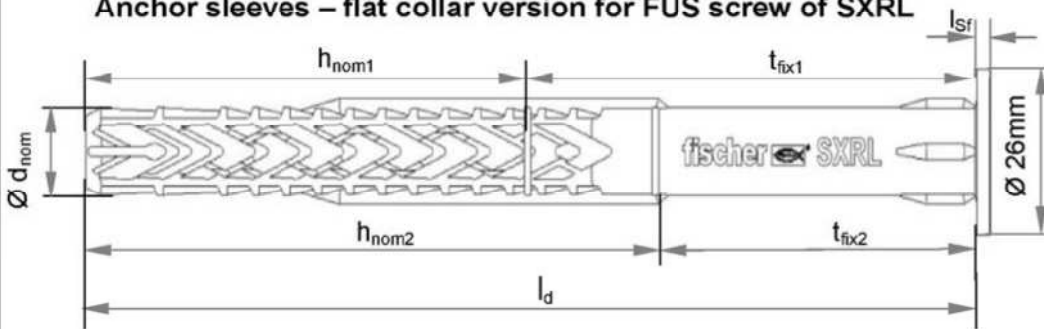

Countersunk version for SK screw also available

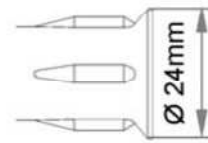

Special screw SK

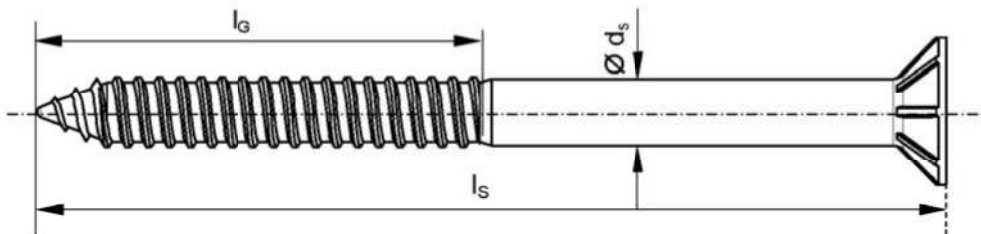

Head of screws: 1),2)

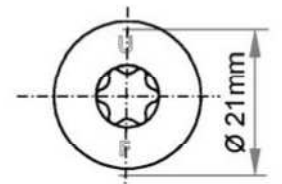

Special screw FUS

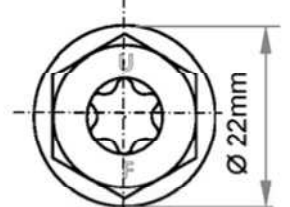
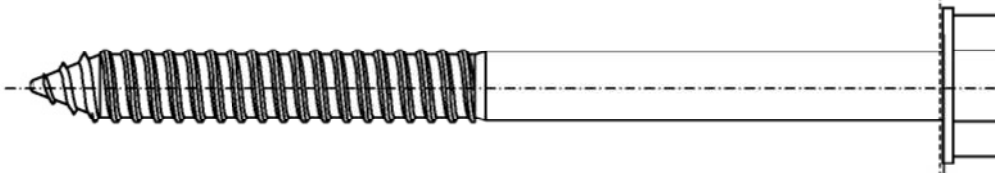

Special screw F

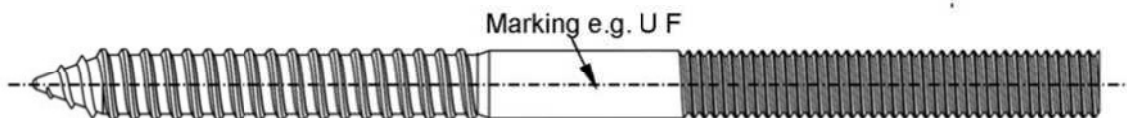
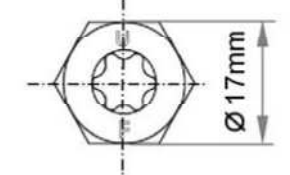
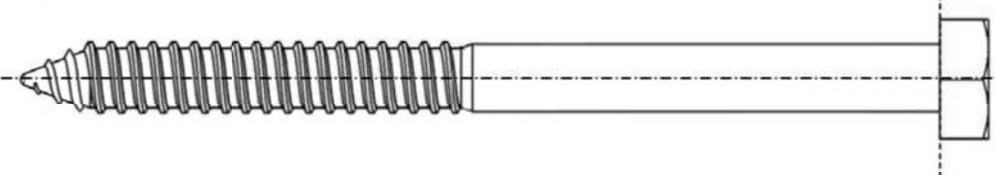

- 1) Additional marking for the special screw, stainless steel version: „A4“.
- 2) Internal driving feature for Torx bit is optional for hexagonal head

SXRL 14

Product description
Anchor types / specific screw

Annex A 2

Table A3.1: Dimensions

Anchor type	Anchor sleeve						Special screw		
	h_{nom1} [mm]	h_{nom2} [mm] ¹⁾	$\varnothing d_{nom}$ [mm]	t_{fix} [mm]	l_d [mm]	l_{sf} ²⁾ [mm]	$\varnothing d_s$ [mm]	l_G [mm]	l_s [mm]
SXRL 14	70	90	14	≥ 1	71-600	3,1	9,6	63	≥ 81 ¹⁾

1) To insure that the screw penetrates the anchor sleeve, l_s must be $l_d + l_{sf}$ ²⁾ + 10 mm

2) Only valid for flat collar version

Table A3.2: Materials

Name	Material
Anchor sleeve	Polyamide, PA6, colour grey
Special screw	<ul style="list-style-type: none"> - Steel gvz A2G or A2F acc. to EN ISO 4042:2001-01 <li style="text-align: center;">or - Steel gvz A2G or A2F acc. to EN ISO 4042:2001-01 + Duplex-coating type Delta-Seal in three layers (total layer thickness $\geq 6 \mu\text{m}$) <li style="text-align: center;">or - Stainless steel acc. to EN 10 088-3:2012, e.g. 1.4401, 1.4571, 1.4578, 1.4362, ...

SXRL 14

Product description
Dimensions and Materials

Annex A 3

Specifications of intended use

Anchorage subject to:

- Static and quasi-static loads.
- Multiple fixing of non-structural applications

Base materials:

- Reinforced or unreinforced normal weight concrete with strength classes \geq C12/15 (use category a), according to EN 206-1:2000.
- Solid brick masonry (use category b), according to Annex C2.
Note: The characteristic resistance is also valid for larger brick sizes and higher compressive strength of the masonry unit.
- Hollow brick masonry (use category c), according to Annex C3.
- Autoclaved aerated concrete (use category d), according to Annex C4.
- Mortar strength class of the masonry \geq M2,5 according to EN 998-2:2010.
- For other base materials of the use categories a, b, c and d the characteristic resistance of the anchor may be determined by job site tests according to ETAG 020, Annex B, Edition March 2012.

Temperature Range:

- c: - 20° C to 50° C (max. short term temperature + 50° C and max long term temperature + 30° C)
- b: - 20° C to 80° C (max. short term temperature + 80° C and max long term temperature + 50° C)

Use conditions (Environmental conditions):

- Structures subject to dry internal conditions (zinc coated steel, stainless steel).
- The specific screw made of galvanised steel or galvanised steel with an additional Duplex-coating may also be used in structures subject to external atmospheric exposure, if the area of the head of the screw is protected against moisture and driving rain after mounting of the fixing unit in this way, that intrusion of moisture into the anchor shaft is prevented. Therefore there shall be an external cladding or a ventilated rainscreen mounted in front of the head of the screw and the head of the screw itself shall be coated with a soft plastic, permanently elastic bitumen-oil-combination coating (e. g. undercoating or body cavity protection for cars).
- Structures subject to external atmospheric exposure (including industrial and marine environment) and to permanently damp internal condition, if no particular aggressive conditions exist (stainless steel).
Note: Particular aggressive conditions are e.g. permanent, alternating immersion in seawater or the splash zone of seawater, chloride atmosphere of indoor swimming pools or atmosphere with extreme chemical pollution (e.g. in desulphurization plants or road tunnels where de-icing materials are used).

Design:

- The anchorages are to be designed in accordance with the ETAG 020, Annex C under the responsibility of an engineer experienced in anchorages and masonry work.
- Verifiable calculation notes and drawings shall be prepared taking account of the loads to be anchored, the nature and strength of the base materials and the dimensions of the anchorage members as well as of the relevant tolerances. The position of the anchor is indicated on the design drawings.
- Fasteners are only to be used for multiple use for non-structural application, according to ETAG 020, Edition March 2012.

Installation:

- Hole drilling by the drill modes according to Annex C1 – C4 for use category b, c and d.
- Anchor installation carried out by appropriately qualified personnel and under the supervision of the person responsible for technical matters of the site.
- Installation temperature from -5°C to + 40°C
- Exposure to UV due to solar radiation of the anchor not protected \leq 6 weeks

SXRL 14	Annex B 1
Intended Use Specifications	

Table B2.1: Installation instructions

Anchor type		SXRL 14
Drill hole diameter	$d_0 =$ [mm]	14
Cutting diameter of drill bit	$d_{cut} \leq$ [mm]	14,45
Depth of drill hole to deepest point ¹⁾	$h_{1,1} \geq$ [mm]	85
Depth of drill hole to deepest point ¹⁾	$h_{1,2} \geq$ [mm]	105
Overall plastic anchor embedment depth in the base material ^{1) 2)}	$h_{nom1} \geq$ [mm]	70
Overall plastic anchor embedment depth in the base material ^{1) 2)}	$h_{nom2} \geq$ [mm]	90
Diameter of clearance hole in the fixture	$d_f \leq$ [mm]	15,40

¹⁾ See Annex 1

²⁾ If the embedment depth is higher than h_{nom} given in Table B2.1 (only for hollow and perforated masonry), job site tests have to be carried out according to ETAG 020, Annex B.

Table B2.2: Minimum thickness of member, edge distance and spacing in concrete

Anchor type SXRL 14		Minimum thickness of member h_{min} [mm]	Characteristic edge distance $c_{cr,N}$ [mm]	Characteristic spacing a [mm]	Minimum edge distances and spacing ³⁾ [mm]
Reinforced Concrete	\geq C16/20	110	100	120	$s_{min} = 60$ for $c \geq 100$ $c_{min} = 60$ for $s \geq 125$
	C 12/15	110	140	135	$s_{min} = 85$ for $c \geq 140$ $c_{min} = 85$ for $s \geq 175$
Unreinforced Concrete	\geq C16/20	110	100	120	$c_{min} = 100$ and $s_{min} = 80$
	C 12/15	110	140	135	$c_{min} = 140$ and $s_{min} = 110$

³⁾ Intermediate values by linear interpolation

Fixing points with a spacing $\leq a$ are considered as a group with a max. characteristic resistance $N_{Rk,p}$ acc. to Table C1.3. For a spacing $> a$ the anchors are always considered as single anchors, each with a characteristic resistance $N_{Rk,p}$ acc. to Table C1.3.

Scheme of distance and spacing in concrete

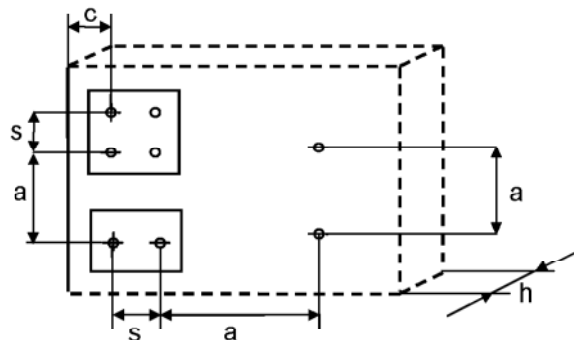

SXRL 14

Intended Use

Installation parameters, edge distances and spacing's for use in concrete

Annex B 2

Table B3.1: Minimum distances and dimensions in masonry

Anchor type			SXRL 14
Minimum thickness of member	h_{min}	[mm]	115
Single anchor			
Minimum spacing	a_{min}	[mm]	250
Minimum edge distance	c_{min}	[mm]	100
Anchor Group			
Minimum spacing perpendicular to free edge	$s_{1,min}$	[mm]	100
Minimum spacing parallel to free edge	$s_{2,min}$	[mm]	100
Minimum edge distance	c_{min}	[mm]	100

Table B3.2: Minimum distances and dimensions in AAC

Anchor type SXRL 14			AAC $f_b \geq 2 \text{ N/mm}^2$		AAC $f_b \geq 4 \text{ N/mm}^2$	
Nominal embedment depth	h_{nom}	[mm]	70	90	70	90
Single anchor						
Minimum thickness of member	h_{min}	[mm]	175	175	300	300
Minimum spacing	a_{min}	[mm]	250	250	250	250
Minimum edge distance	c_{min}	[mm]	80	80	100	120
Anchor Group						
Minimum thickness of member	h_{min}	[mm]	240	300	300	300
Minimum spacing perpendicular to free edge	$s_{1,min}$	[mm]	80	80	80	100
Minimum spacing parallel to free edge	$s_{2,min}$	[mm]	80	100	80	125
Minimum edge distance	$c_{1,min}$	[mm]	120	120	120	150
Minimum edge distance perpendicular to c_1	$c_{2,min}$	[mm]	150	150	150	150

Scheme of distance and spacing in masonry and AAC

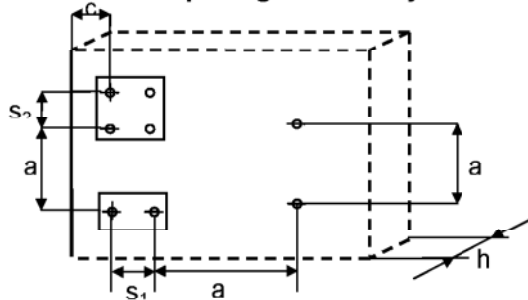

SXRL 14

Intended Use

Installation parameters, edge distances and spacing's for use in masonry and AAC

Annex B 3

Installation instructions (the following pictures show fixing through timber)

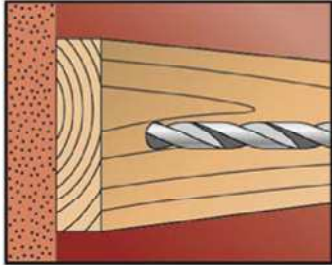

1. Drill the bore hole \varnothing 14 mm using the drill method described in the corresponding annex.

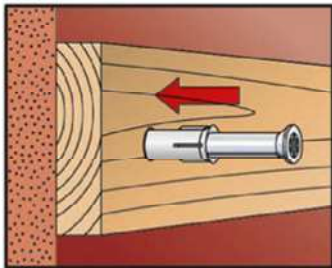

2. Insert assembly group of anchor (screw and plug) using a hammer until the plastic sleeve is flush with surface of fixture.

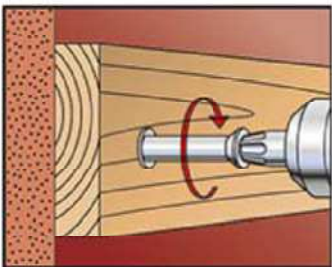

3. The screw is screwed-in until the head of the screw touches the sleeve.

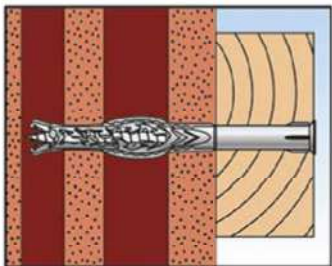

4. Correctly installed anchor in hollow masonry.

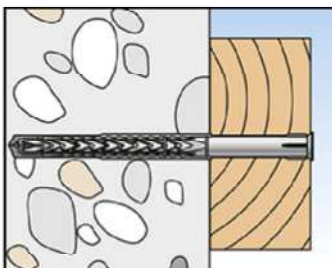

5. Correctly installed anchor in concrete.

SXRL 14

Intended use
Installation instructions

Annex B 4

Table C1.1: Characteristic bending resistance of the screw

Anchor type		SXRL 14			
		Galvanised steel		Stainless steel	
Material		Galvanised steel		Stainless steel	
Overall plastic anchor embedment depth in the base material		h_{nom1} 70mm	h_{nom2} 90mm	h_{nom1} 70mm	h_{nom2} 90mm
Characteristic bending resistance	$M_{Rk,s}$ [Nm]	48,7	62,5	47,0	60,5
Partial safety factor	γ_{Ms} ¹⁾	1,25		1,29	

¹⁾ In absence of other national regulations

Table C1.2: Characteristic resistance of the screw

Failure of expansion element (special screw)		SXRL 14	
		Galvanized steel	Stainless steel
Characteristic tension resistance	$N_{Rk,s}$ [kN]	43,4	42,0
Partial safety factor for $N_{Rk,s}$	γ_{Ms} ¹⁾	1,50	1,55
Characteristic shear resistance	$V_{Rk,s}$ [kN]	21,7	21,0
Partial safety factor for $V_{Rk,s}$	γ_{Ms} ¹⁾	1,25	1,29

¹⁾ In absence of other national regulations

Table C1.3: Characteristic resistance for use in concrete

Pull-out failure (plastic sleeve)		SXRL 14
Temperature range		50/80 °C 30/50 °C
Concrete \geq C12/15		
Characteristic resistance	$N_{Rk,p}$ ²⁾ [kN]	8,5
Partial safety factor	γ_{Mc} ¹⁾	1,8

¹⁾ In absence of other national regulations

²⁾ Hammer drilling

Table C1.4: Displacements under tension und shear loading in concrete and masonry

Anchor type	Tension or shear load F [kN]	Displacements under tension load ^{3), 4)}		Displacements under shear load ^{3), 4)}	
		δ_{NO} [mm]	$\delta_{N\infty}$ [mm]	δ_{VO} [mm]	$\delta_{V\infty}$ [mm]
SXRL 14	3,40	0,39	0,63	2,79	4,19

³⁾ Valid for all ranges of temperatures

⁴⁾ Intermediate values by linear interpolation

Tabelle C1.5: Characteristic values under fire exposure in concrete C20/25 to C50/60 in any load direction, no permanent centric tension load and without lever arm

Fire resistance class	F_{Rk}
R 90	$\leq 0,8$ kN

SXRL 14

Performances
Characteristic resistance,
Displacements under tension and shear loading in concrete and masonry

Annex C 1

Table C2.1: SXRL 14 characteristic resistance F_{RK} in [kN] in solid masonry (use category "b")

Base material [Supplier]	Min. DF or min. size (L x W x H) [mm]	Minimum compressive strength f_b [N/mm ²] bulk density $\geq \rho$ [kg/dm ³]	Drilling method ¹⁾	Characteristic resistance SXRL 14 F_{RK} [kN]	
				$h_{nom1} \geq 70\text{mm}$	
				50/80 °C	30/50 °C
Clay brick, Mz e.g. acc. to DIN 105-100:2012-01, EN 771-1:2011,Mz e.g. Ebersdobler Mz	NF (240x115x71)	20/1,8	H	4,0 / 6,0 ²⁾	4,0 / 7,0 ²⁾
		10/1,8		3,0 / 4,5 ²⁾	3,0 / 5,0 ²⁾
Calcium silicate solid brick KS e.g. acc. to DIN V 106:2005-10, EN 771-2:2011 e.g. Wemding KSV	NF (240x115x71)	20/1,8	H	4,5 / 5,0 ²⁾	4,5 / 6,0 ²⁾
		10/1,8		3,0 / 3,5 ²⁾	3,0 / 4,0 ²⁾
	12 DF (495x175x240)	12/1,8	H	4,0 / 11,0 ²⁾	4,0 / 11,5 ²⁾
		10/1,8		3,5 / 9,0 ²⁾	3,5 / 9,5 ²⁾
		8/1,8		2,5 / 7,5 ²⁾	2,5 / 7,5 ²⁾
		6/1,8		2,0 / 5,5 ²⁾	2,0 / 5,5 ²⁾
		4/1,8		1,2 / 3,5 ²⁾	1,2 / 3,5 ²⁾
Lightweight solid brick,V, e.g. acc. to DIN V 18152-100:2005-10 EN 771-3:2011, e.g. KLB VL	(250x240x245)	10/1,6	H	3,5 / 6,0 ²⁾	3,5 / 7,0 ²⁾
		8/1,6		3,0 / 5,0 ²⁾	3,0 / 6,0 ²⁾
		6/1,6		2,0 / 3,5 ²⁾	2,0 / 4,5 ²⁾
		4/1,6		1,5 / 2,5 ²⁾	1,5 / 3,0 ²⁾
	2DF (240x115x113)	2/1,2		0,9	1,2
Partial safety factor			γ_{Ms} ³⁾	2,5	

1) H = Hammer drilling, R = Rotary drilling

2) Only for edge distance $c \geq 200$ mm; intermediate values by linear interpolation

3) In absence of other national regulations

SXRL 14

Performances

Characteristic resistance for use in solid masonry

Annex C 2

Table C3.1: SXRL 14 characteristic resistance F_{Rk} in [kN] in hollow masonry (use category "c")

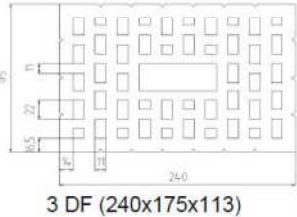
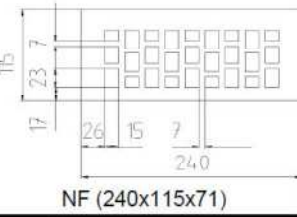
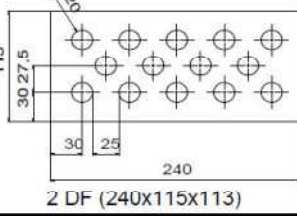
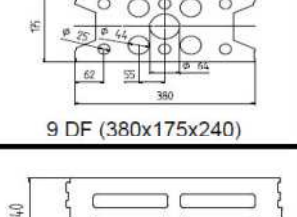
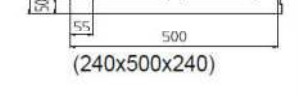
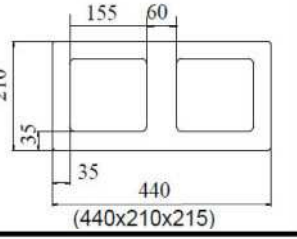
Base material [Supplier]	Geometry and min. DF or min. size (L x W x H) [mm]	Min. compressive strength f_b [N/mm ²] / bulk density $\geq \rho$ [kg/dm ³]	Drilling method ¹⁾	Characteristic resistance F_{Rk} SXRL 14 [kN]			
				h_{nom1} 70mm*		h_{nom2} 90mm*	
				50/80 °C	30/50 °C	50/80 °C	30/50 °C
Vertically perforated clay bricks e.g. acc. to DIN 105-100:2012-01, EN 771-1:2011, Schlagmann HLz	 3 DF (240x175x113)	12/1,0	R	2,0		2,5	
		10/1,0		2,0		2,0	
		8/1,0		1,5		1,5	
		6/1,0		1,2		1,2	
Vertically perforated clay bricks e.g. acc. to DIN 105-100:2012-01, EN 771-1:2011, Wienerberger HLz	 NF (240x115x71)	48/1,6	R	4,5	5,0	4,5	5,0
		28/1,6		2,5	3,0	2,5	3,0
		20/1,6		1,5	2,0	1,5	2,0
Hollow calcium silicate brick KSL, acc. to DIN V 106:2005-10, EN 771-2:2011 e.g. KS Wemding KSL	 2 DF (240x115x113)	12/1,4	H	1,5	2,0	2,5	
		10/1,4		1,5		2,0	
		8/1,4		1,2		1,5	
		6/1,4		0,9		1,2	
Hollow calcium silicate brick acc. to DIN V 106:2005-10, EN 771-2:2011 e.g. Xella KS	 9 DF (380x175x240)	20/1,4	H	3,5	4,0	1,5	2,0
		10/1,4		1,5	2,0	0,75	0,9
Hollow brick leightweight concrete, e.g. acc. to DIN V 18153-100: 2005-10, EN 771-3:2011, e.g. KLB, Hbl	 (240x500x240)	2/0,7	R	1,2	1,5	0,75	
Hollow brick leightweight concrete, e.g. acc. to DIN V 18153-100: 2005-10, EN 771-3:2011, e.g. Masonry Roadstone	 (440x210x215)	10/1,2	R	3,0		-	
		8/1,2		2,5		-	
		6/1,2		2,0		-	
		4/1,2		1,2		-	
		2/1,2		0,6		-	
Partial safety factor			γ_{Ms} ³⁾	2,5			

Foot prints see Annex C2 * Intermediate values by linear interpolation

SXRL 14

Performances

Characteristic resistance for use in hollow or perforated masonry

Annex C 3

Table C4.1: Characteristic resistance F_{RK} in [kN] in autoclaved aerated concrete (AAC) (use category "d")

Base material	Minimum compressive strength $f_b \geq$ [N/mm ²]	Characteristic resistance F_{RK} SXRL 14		
		Drilling method	Temp. range "b" and "c" 50/80 °C	
			h_{nom1} 70mm	h_{nom2} 90mm
Autoclaved aerated concrete blocks, e.g. AAC acc. to DIN V 4165-100:2005-10, EN 771-4:2011	6	Hammer drilling	4,0	5,0
	4		2,5	3,0
	3		1,5	2,0
	2		0,9	1,2

Table C4.2: Displacements under tension and shear loading in autoclaved aerated concrete (AAC)

Anchor type	Tension or shear load F [kN]	Displacements under tension load ²⁾		Displacements under shear load ²⁾	
		δ_{N0} [mm]	$\delta_{N\infty}$ [mm]	δ_{V0} [mm]	$\delta_{V\infty}$ [mm]
$h_{nom} = 70/90\text{mm}$ $f_b \geq 2 \text{ N/mm}^2$	0,32/0,43	0,19/0,25	0,38/0,50	0,64/0,86	0,96/1,29
$h_{nom} = 70/90\text{mm}$ $f_b \geq 3 \text{ N/mm}^2$	0,60/0,77	0,23/0,31	0,45/0,63	1,19/1,54	1,79/2,31
$h_{nom} = 70/90\text{mm}$ $f_b \geq 4 \text{ N/mm}^2$	0,88/1,11	0,26/0,38	0,53/0,76	1,75/2,22	2,62/3,33
$h_{nom} = 70/90\text{mm}$ $f_b \geq 6 \text{ N/mm}^2$	1,43/1,79	0,34/0,51	0,68/1,02	2,86/3,58	4,29/5,37

¹⁾ Valid for all ranges of temperatures

²⁾ Intermediate values by linear interpolation

SXRL 14

Performances

Characteristic resistance and displacements for use in autoclaved aerated concrete

Annex C 4