

# HAKKO

Quality Tools For The Electronics Industry

Europe version

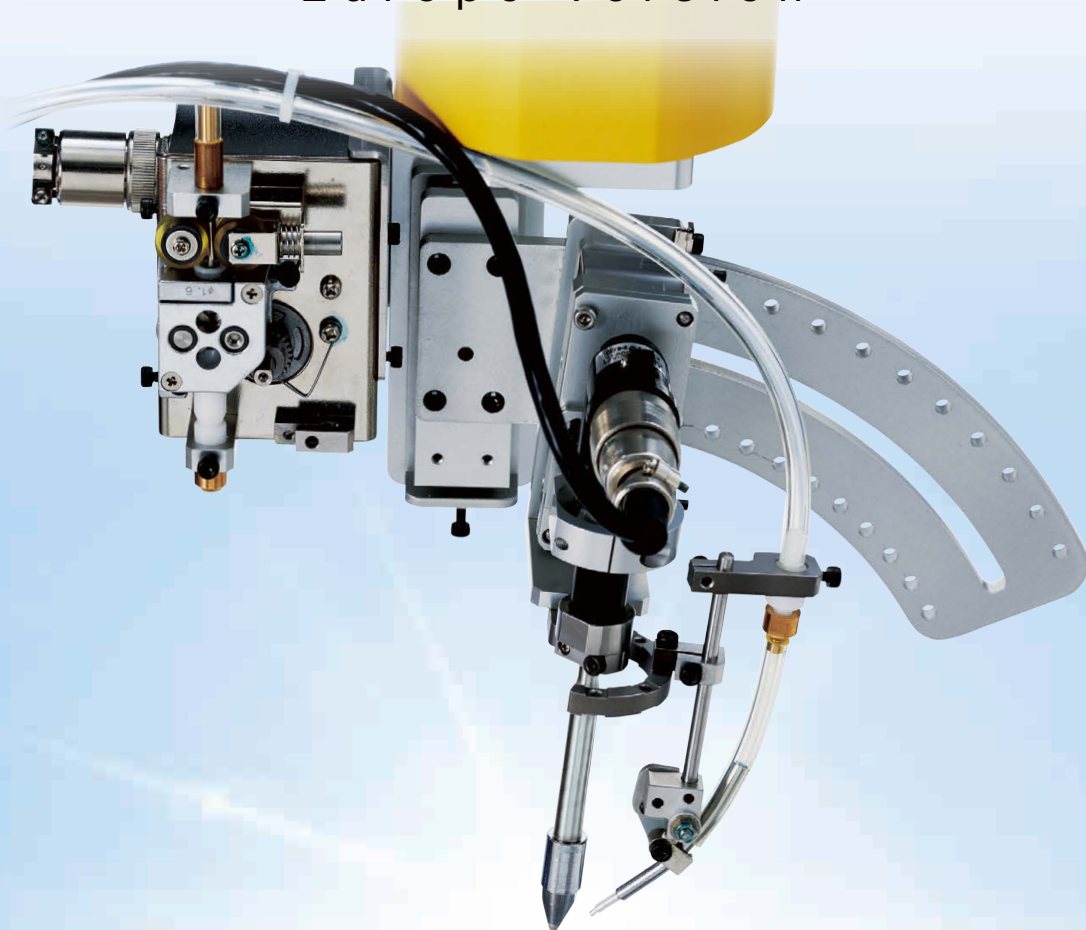

*Challenge Toward Innovation*



# HAKKO GIO



## HAKKO brand is much loved in more than 50 countries worldwide.

HAKKO has grown into a global brand. Our soldering irons and related equipment are hard at work in more than 50 countries. We have local branches and sales representatives around the world, and continue to expand our global network.



<https://www.hakko.com>

**HAKKO** is registered in countries and regions including the following.  
Japan, USA, South Korea, Singapore, China, the member of CTM.

# Global Network

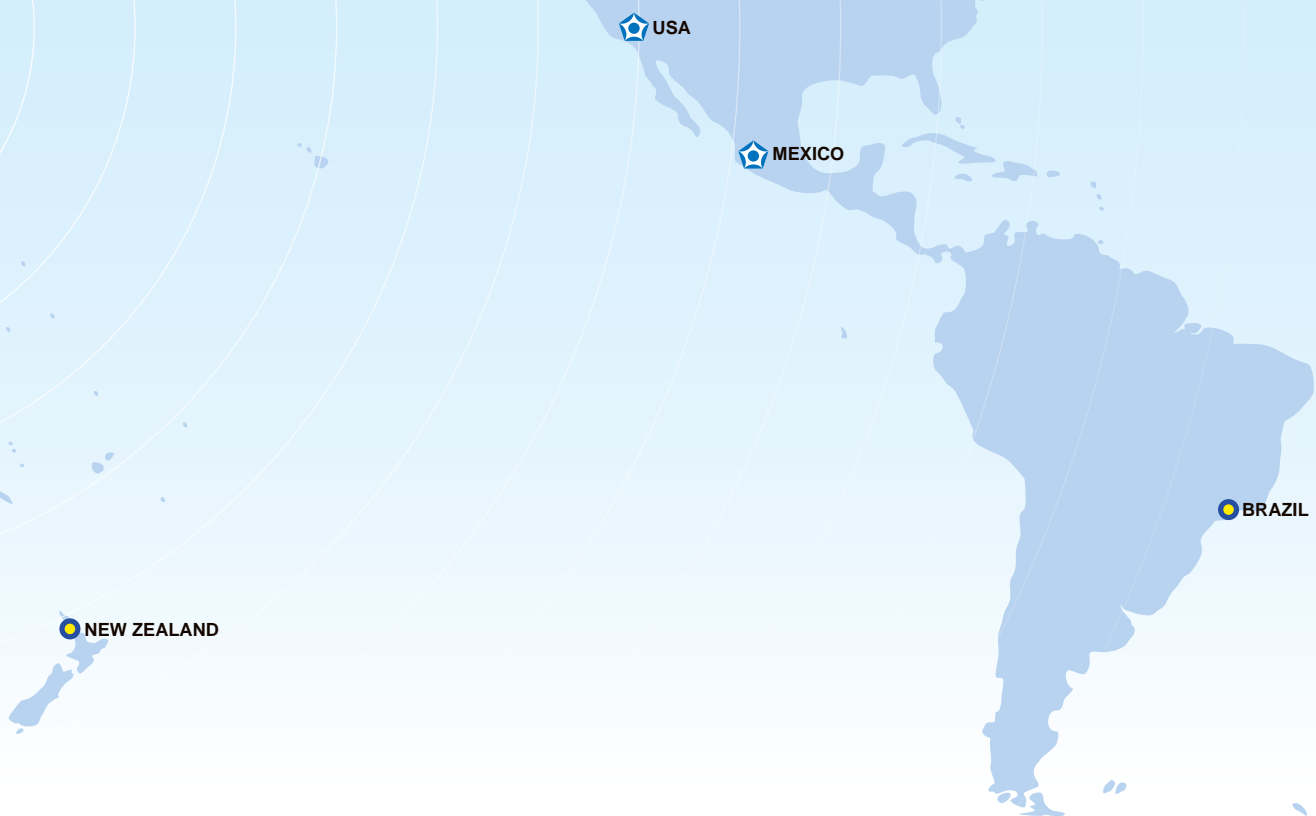

As of Mar. 2021

## 《《《《 WORLDWIDE NETWORK 》》》》

For more details on HAKKO affiliates and distributors, visit the official HAKKO website at [www.hakko.com](http://www.hakko.com)

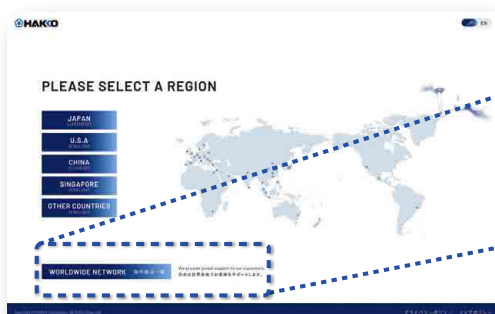

Best suited for soldering P.W.B. with high heat capacity and high heat dissipation property  
Make the impossible possible with Super Power of 300 W Heater

Heavy Duty Soldering Station

# FX-801 ESD SAFE » P.28

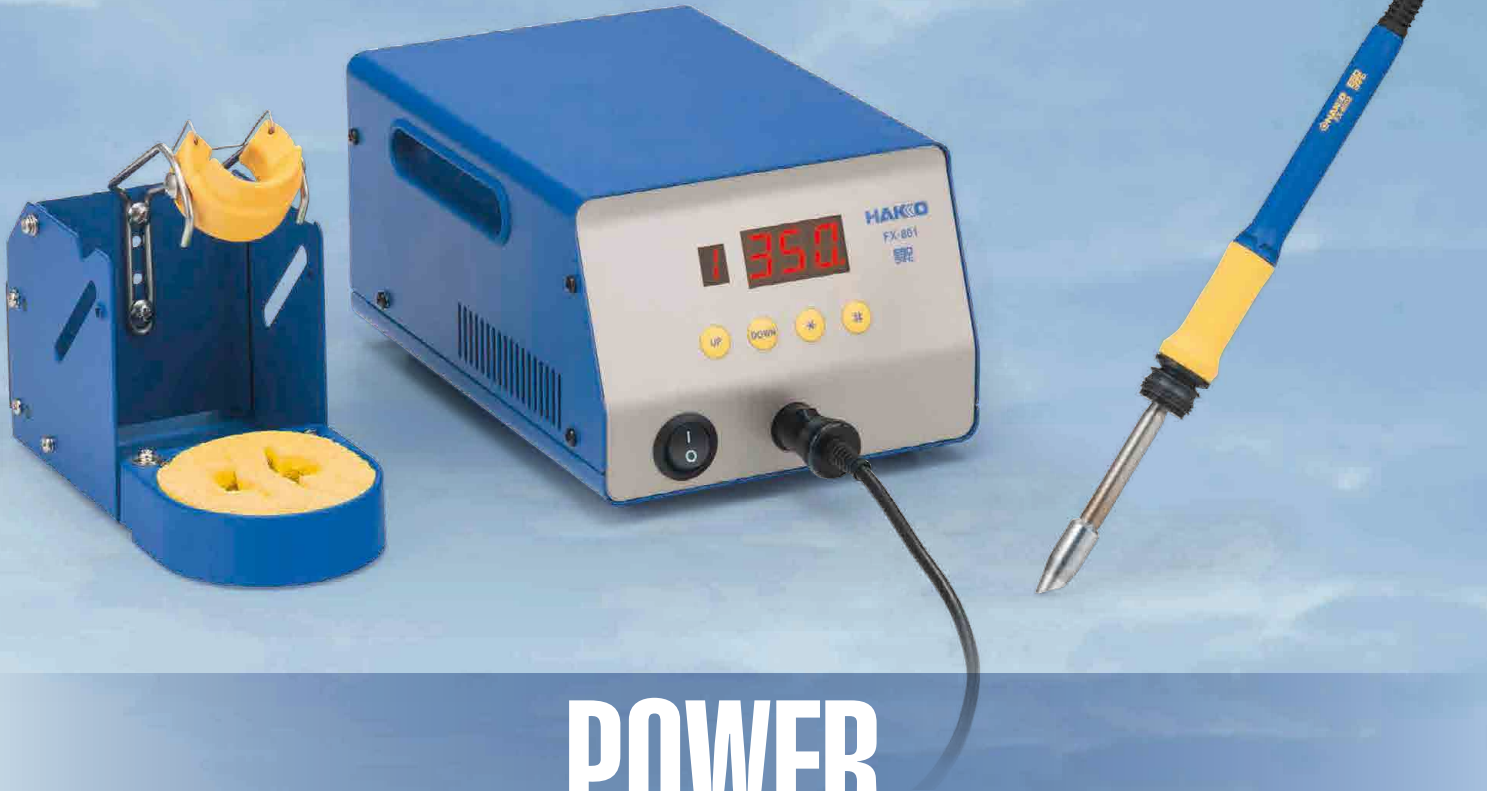

# POWER SOLDERING™

300 W heavy duty desoldering tool with built-in vacuum pump  
Secure desoldering with valve function

Heavy Duty Desoldering Tool

# FR-400 ESD SAFE » P.70



Ideal for Micro Soldering applications under a microscope

Micro Soldering Iron

# FM-2032 ESD SAFE

Connectable to the stations below

FX-951 FM-203 FM-206

P.16

P.20

P.20



Micro Soldering Iron

# FX-1002 ESD SAFE >> P.15



# MICRO SOLDERING

# WIRE HARNESS ASSEMBLY

Thermal wire stripper that ensures clean-cut removal of wire insulation

Thermal Wire Stripper

# FT-802 ESD SAFE >> P.92

Stepless control on temperature and airflow for optimal settings

Heating Gun

# FV-310 >> P.98



Temperature control knob

Airflow control knob



# Quality Tools for the



HAKKO is certified under ISO 9001 (JIS Q 9001),  
the international standard for quality management systems.  
We are also certified under ISO 14001 (JIS Q 14001)  
and are actively involved in preserving the global environment.

See the official HAKKO website for all necessary information regarding HAKKO products and services.

## • HAKKO WEBSITE

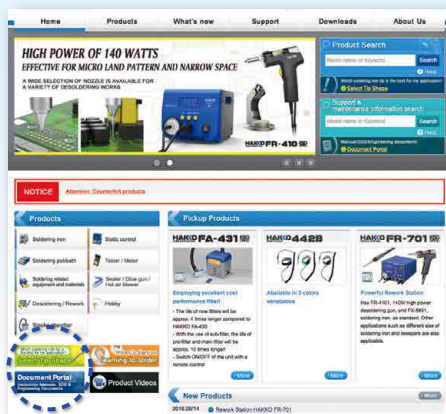

## • SELECT TIP SHAPE

Search for the appropriate tip for your work by following the guidelines.



[https://www.hakko.com/english/tip\\_selection/](https://www.hakko.com/english/tip_selection/)

## • DOCUMENT PORTAL

Download instruction manuals, SDSs, and technical documents from the HAKKO Document Portal.

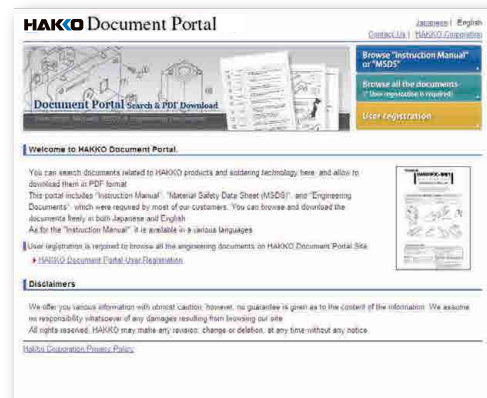

<https://doc.hakko.com/?l=en>

# Electronics Industry



## FN-1010 ESD SAFE

IoT Capable Soldering Station

Page 10



## FG-101B

Soldering Iron Tester with Auto-measurement Function

Page 56



## 373 ESD SAFE

Self Feeder and the New Tube Unit

Page 48



## FT-720 ESD SAFE

Tip Cleaner

Page 58



## FG-465

Footwear Tester

Page 87



## FG-470

Wrist Strap Tester

Page 86



# Index

## Soldering Iron

### IoT Capable Type

**FN-1010**  
100 W



P.10

### Station Type & Accessories

**FX-100**  
IH



P.14

**FX-1002**  
Micro Soldering Iron



P.15

**FX-951**  
70 W



P.16

**FX-950**  
70 W



P.16

**FM-2032**  
Micro Soldering Iron (48 W)



P.17

**FM-203**  
2-Port Type



P.20

**FM-206**  
3-Port Type



P.20

**FM-2027**  
Soldering Iron (70 W)



P.21

**FM-2032**  
Micro Soldering Iron (48 W)



P.21

**FM-2022**  
SMD Hot Tweezers (140 W)



P.21

**FM-2023**  
Mini SMD Hot Tweezers (140 W)



P.21

**FM-2024**  
Desoldering Tool (70 W)



P.21

**FM-2029**  
Hot Air Pencil (140 W)



P.21

**FM-2030**  
Heavy Duty Soldering Iron (140 W)



P.21

**FX-801**  
300 W



P.28

**FX-838**  
150 W



P.30

**FX-888D**  
65 W



P.32

**FX-889**  
2-Port Type



P.32

**FX-8801**  
Soldering Iron M type (65 W)



P.35

**FX-8803**  
Soldering Gun (65 W)



P.35

**FX-8804**  
SMD Hot Tweezers (65 W)



P.35

**FX-8805**  
Soldering Iron L type (65 W)



P.35

### N<sub>2</sub> System

**FX-780**  
N<sub>2</sub> Generator



P.38

**FX-781**  
N<sub>2</sub> Generator



P.38

**FX-791**  
N<sub>2</sub> Flowmeter



P.38

**FN-1102**  
N<sub>2</sub> Soldering Iron (95 W)



P.39

**FX-8003**  
N<sub>2</sub> Soldering Iron (260 W)



P.39

**FX-8302**  
N<sub>2</sub> Soldering Iron (150 W)



P.39

**FM-2031**  
N<sub>2</sub> Soldering Iron (140 W)



P.39

**FM-2032**  
N<sub>2</sub> Micro Soldering Iron (48 W)



P.39

**FM-2026**  
N<sub>2</sub> Soldering Iron (70 W)



P.39

**FX-8802**  
N<sub>2</sub> Soldering Iron (65 W)



P.39

### Ceramic Heater Type

**DASH**



P.44

**FX-901**  
Battery-Powered Soldering Iron



P.45

### Flux Pen & Reel Stand

**FS-210**



P.46

**611**

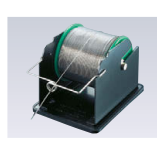

P.46

## Solder Feeder

### Solder Feed System

**373**  
Self Feeder



P.48

**375**  
V-Groove Maker



P.47

## Thermometer & Soldering Tester

### Thermometer

**FG-100B**



P.52

**FG-102**



P.54

### Soldering Tester

**FG-101B**



P.56

## Tip Cleaner

### Tip Cleaner

**FT-720**



P.58

**FT-710**



P.58

### Maintenance Kit

**FT-700 & FS-100**



P.61

## Fume Extractor

### Air-Purifying Type

**FA-430**  
HEPA Filter



P.62

**FA-431**  
Cost Performance Filter



P.63

### Desktop Type

**FA-400**



P.65



## Soldering Pot

### Soldering Pot

**FX-301B**  
High Performance Type



P.66

**FX-300**  
High Performance Type



P.66

**96**



P.67

## Desoldering & Rework

### Desoldering Tool

**FR-400**  
300 W



P.70

**FR-410**  
140 W



P.70

**FM-204**  
70 W



P.73

**FR-301**  
Portable Type



P.68

**SPPON**



P.74

### Desoldering Wire WICK

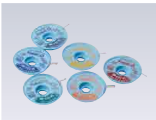

P.74

### Hot-Air SMD Rework Station

**FR-810B**



P.76

**FR-811**



P.76

### Preheater

**FR-830**  
Hot Air Type



P.75

## Rework Station

### Repair System

**FR-701**  
2-Port Type



P.84

### Rework System

**FR-702**  
4-Port Type



P.85

### Wrist Strap

**442B**

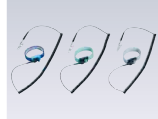

P.86

### Wrist Strap Tester

**FG-470**



P.86

### Footwear Tester

**FG-465**

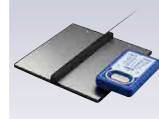

P.87

## Static Control

## Vacuum Pick-Up Tool

### Vacuum Pick-Up Tool

**393**  
Dropper Type



P.90

**394**  
Battery-Powered Type



P.90

## Tool for Lead & Wire

### Thermal Wire Stripper

**FT-802**  
Thermal Wire Stripper

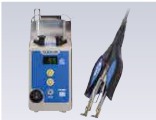

P.92

### Lead Forming Tool

**153 & 154**  
Lead Cutter And Former



P.94

**155**  
Lead Cutter



P.94

**DIPLINER**  
Lead Straightener

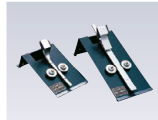

P.95

### Hand Tool

**HAND TOOLS**



P.96

**106**  
Cutting Tool



P.97

## Heating Gun





### Heating Gun

**FV-310**



P.98

# HAKKO Soldering Iron Lineup

		FN-1010	FX-100	FX-951	FX-950	FM-203	
							
Types		IoT Capable	IH	High Performance			
Specifications	Power consumption	100 W	25 W (85 W)	75 W	75 W	140 W	
	Power consumption of Handpiece	95 W	—	70 W	70 W	70 W × 2 port	
	Temperature Range	50 to 450°C	350°C/400°C/450°C	200 to 450°C	200 to 450°C	200 to 500°C	
	Soldering Tip	T36 series	T31 series	T15 series	T15 series	T15 series	
Applicable Standard	Lead Free Suggestible	●	●	●	●	●	
	ESD Safe	●	●	●	●	●	
	RoHS Suggestible	●	●	●	●	●	
Accessories	Micro Soldering Iron connectable		●	●		●	
	N <sub>2</sub> Micro Soldering Iron connectable			●		●	
	N <sub>2</sub> Soldering Iron connectable	●		●	●	●	
	N <sub>2</sub> Heavy Duty Soldering Iron connectable					●	
	Self Feeder connectable	●	●	●	●	●	
	SMD Hot Tweezers connectable					●	
	Desoldering Iron connectable					●	
	Hot Air Handpiece connectable						
Function	Auto Shutoff Function: When a set time passed, the function stops to supply power to the heating element.						
		●	●	●		●	
	Auto Sleep Function: When a set time passed, the tip temperature decreases to a set lower temperature.						
		●	●	●	● Option	●	
	Lock Function: Lockable by password, control card or lock key.						
		Password	Password	Control card	Lock key	Control card	
	Lower Temperature Error Alert: When the temperature drops below a set limit, an error is displayed and the buzzer sounds.						
		●		●		●	
	Offset Temperature Function: Temperature offsettable by analog, digital or adjustment mode.						
	Digital		Digital	Manual	Digital		
Preset Temperature Function: The function allows to input several frequently-used temperatures and recall with one push of a button.							
	●						



## FN-1010 ESD SAFE

IoT Capable Soldering Station **Digital**

Tip not included

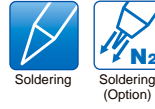

- Enables human error-free temperature control and traceability of manual soldering process

### Optional Tips for FN-1101

Unit: mm

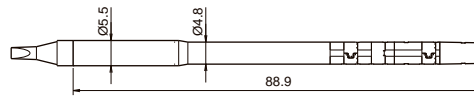

<b>T36-B Shape-0.2B</b> 	<b>T36-B2 Shape-0.5B</b> 	<b>T36-BL Shape-BL</b> 	<b>T36-BC1 Shape-1BC</b> 	<b>T36-BC2 Shape-2BC</b> 	<b>T36-BC3 Shape-3BC</b> 
<b>T36-C1 Shape-1C</b> 	<b>T36-C4 Shape-4C</b> 	<b>T36-D08 Shape-0.8D</b> 	<b>T36-D16 Shape-1.6D</b> 	<b>T36-D24 Shape-2.4D</b> 	<b>T36-DL32 Shape-3.2DL</b> 
<b>T36-D52 Shape-5.2D</b> 	<b>T36-I Shape-I</b> 	<b>T36-ILS Shape-ILS</b> 	<b>T36-J02 Shape-0.2J</b> 	<b>T36-JS02 Shape-0.2JS</b> 	<b>T36-K Shape-K</b> 

## Features

“Process control” and “Traceability” can be established through daily manual soldering operation.



### Information to be collected by T36 series tip

The following information can be collected by memory chip in T36 series tip and saved in a computer through a soldering station.

- Tip shape
- Serial number
- Number of loads
- Total time of power supplied
- Load Sensitivity
- Type of solder alloy (Lead-Free / Lead)
- Count alarm



Optimization of soldering conditions is now possible based on a variety of information in daily soldering process collected by FN-1010.

### Connectable with N<sub>2</sub> soldering iron

To improve solder wettability and spreadability

## FN-1102 氮

### N<sub>2</sub> Soldering Iron

Tip not included

Please see the optional tips on P.40.



For further details, see the N<sub>2</sub> system (P.38 & P.39).

### Packing List

FN-1010	Station, Handpiece (FN-1101), Tip cleaner (FT-401, with cleaning wire), Power cord, Iron holder, Instruction manual
FN-1102	Handpiece, Instruction manual

### Specifications

Model No.	FN-1010
Power consumption	100 W
Temperature range	50 to 450°C
Temperature stability	±3°C at idle temperature

#### Station

Output voltage	AC 21 V
Dimensions	104 (W) × 138 (H) × 152 (D) mm
Weight	1.9 kg

#### Soldering Iron

Power consumption	95 W (21 V)
Tip to ground resistance	<2 Ω
Tip to ground potential	<2 mV
Heating element	Composite heater
Cord length	1.2 m
Total length*	180 mm (with 2.4D tip)
Weight*	32 g (with 2.4D tip)

\* Without cord

Model No.	FN-1102
Power consumption	95 W (21 V)
Tip to ground resistance	<2 Ω
Tip to ground potential	<2 mV
Heating element	Composite heater
Cord length	1.2 m
Total length*	180 mm (with 2.4D tip)
Weight*	50 g (with 2.4D tip and nozzle assembly A)

\* Without cord and tube

## More Features

Automatic calibration/off-set can be completed once measurement result is sent through infrared.



Human error-free “tip temperature calibration” and “off-set” can be established through daily manual soldering process. Results of measurement/calibration/off-set can be recorded automatically.

Eliminate human error in manual recording of measurement result by using FG-100B

Human errors in manual recording process and time for recording can be eliminated by sending measurement result from FG-100B to FN-1010.



For further information of FG-100B, see P. 52.

## Visualize energy supplied during soldering

It is now possible to visualize invisible energy supplied from T36 series tip during soldering. And that makes it possible to control factors of soldering, which were impossible before.



Start Time	Time	Sensor Temp	Load Energy
	141.05	350	0
	141.225	349	2
	141.4	346	5
	141.575	344	9
	141.75	340	15
	141.925	340	23
	142.1	339	33
	142.275	337	42
	142.45	334	47
	142.625	331	48
	142.8	330	47
	142.975	339	53
	143.15	344	55
	143.325	343	54
	143.5	343	0

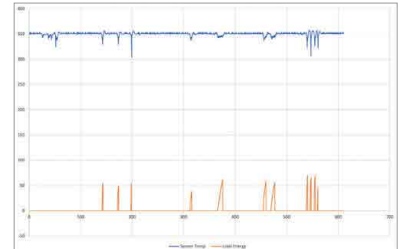

## Real-time work status on the LCD screen

Set temperature Tip shape

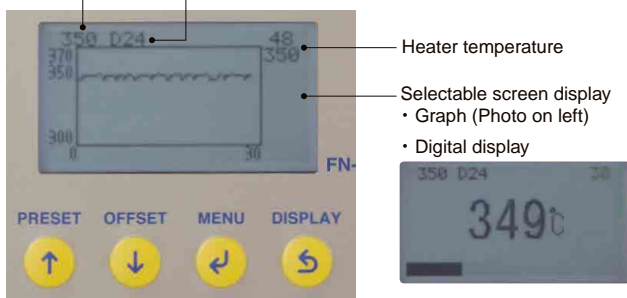

## Notification of alarm with sound and vibration

Alarm can be notified with vibration in a noisy environment.

## Free fall detection function

Built-in motion sensor detects free fall and cuts the power. It can prevent burning floor, a fire and other accident with the heat.



## Improved button operation

Quick access to “Preset temperatures” and “Off-set mode” with one push.

It takes few button operation to access to most frequently used functions.

### Tip cleaner with solder ball preventive design

Solder ball during tip cleaning can be reduced by 99% with devised cleaner designs such as smaller aperture, and set angle as well as position.

\* In-house comparison





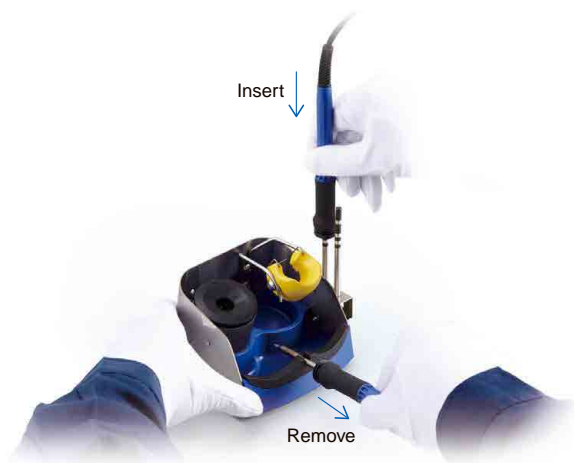

### Tip replacement without heat resistant pad



### Option for IoT communication

Please choose the options according to the numbers of units and the connection port of PC and server.

Type	Specifications and Part No.	Connectable numbers	Compatibility with PC	Sequence control	Example of connection
Interface Card for FN-1010	 USB type with cable No. B5210	One unit per one PC	○	✗	
	 RS232C type with cable No. B5211	One unit per one PC	△*	○	
	 LAN type No. B5212	Multiple units per one PC	○	✗	

\* RS232C cannot be connected with some PCs. Please check.

## FX-100 ESD SAFE



IH Soldering Station **Digital**

Tip not included



- Provides the heat to the tip effectively by an 'Induction heater'
- Unique "Power assist" feature that assists the thermal recovery performance of the soldering iron tip
- No calibration is required.
- Wide variety of tips available
- Meets or exceeds IPC J-STD-001 and ANSI ESD S20.20.

### Optional Tips for FX-1001

Unit: mm

T31-XX BC1 "01" for 450°C (A: 71.5) "02" for 400°C (A: 68.5) "03" for 350°C (A: 68.5)				
T31-01BC1 Shape-1BC T31-02BC1 T31-03BC1 	T31-01BC28 Shape-2.8BC T31-02BC28 T31-03BC28 	T31-01BL Shape-BL T31-02BL T31-03BL 	T31-01D08 Shape-0.8D T31-02D08 T31-03D08 	T31-01D16 Shape-1.6D T31-02D16 T31-03D16 
T31-01D24 Shape-2.4D T31-02D24 T31-03D24 	T31-01D52 Shape-5.2D T31-02D52 T31-03D52 	T31-01I Shape-I T31-02I T31-03I 	T31-01IL Shape-IL T31-02IL T31-03IL 	T31-01J02 Shape-0.2RSB T31-02J02 T31-03J02 
T31-01JL02 Shape-0.2RLB T31-02JL02 T31-03JL02 	T31-01JS02 Shape-0.2RSSB T31-02JS02 T31-03JS02 	T31-01KU Shape-KU T31-02KU T31-03KU 	T31-01SBL Shape-SBL T31-02SBL T31-03SBL 	T31-01WD08 Shape-0.8WD T31-02WD08 T31-03WD08 

### Optional Tips for FX-1002

Unit: mm

T35-XX D06 "02" for 400°C (A: 64) "03" for 350°C (A: 64)				
T35-02D06 Shape-0.6D T35-03D06 	T35-02D1 Shape-1D T35-03D1 	T35-02I Shape-I T35-03I 	T35-02J Shape-J T35-03J 	T35-02KU Shape-KU T35-03KU 



## Features

### IH (induction heater) for excellent thermal efficiency. Ideal for the most challenging soldering jobs.

FX-100 features IH (induction heater) that continuously powers the soldering iron and maintains the set temperature by automatically detecting even minute drops in temperature, plus HAKKO's proprietary "Power Assist" function.

FX-100 achieves powerful thermal recovery even with fine-shaped tips.

It provides excellent thermal responsiveness that conventional IH and sensor feedback systems cannot offer.

### Boost function

To increase tip temperature by 5 to 10°C (depends on tip shape) for better working efficiency.



### Interactive method by LCD display with 3 buttons

#### PROFILE

```
PROFILE 1
S:HAKKO-1
U:ID-123
S:0.6 LEAD FREE
```

Station ID, user name and solder type can be registered.

#### TIP LOAD

```
TIP LOADS
APPROX.
000025 points
<RESET> <OK>
```

The soldering count is displayed.

#### TIP TIME

```
TIP TIME
0023 hours
<RESET> <OK>
```

The cumulative running time on the iron tip is displayed.

#### TIP TYPE and NORMAL MODE/BOOST MODE

```
<01>
N
■■■■■■
```

Visible tip type (01/02/03) and normal mode (N)/boost mode (B) on display

### Connectable with micro soldering iron

For micro soldering applications under a microscope

## FX-1002 錫

### Micro Soldering Iron

Tip not included



### Packing List

<b>FX-100</b>	Station, Handpiece (FX-1001), Heat resistant pad, Power cord, Sleeve (green), Sleeve (gray), Cleaning wire, Iron holder, Instruction manual
<b>FX-1002 (Conversion kit)</b>	Handpiece, Sleeve (green), Heat resistant pad, Iron holder, Instruction manual

## Specifications

Model No.	FX-100
Power consumption	28 W (85 W)
Temperature range	T31-01 Series: 450°C, T31-02 Series: 400°C T31-03 Series: 350°C
Temperature stability	±1.1°C

### Station

Output power	50 W
Output frequency	13.56 MHz
Dimensions	127 (W) × 150 (H) × 167 (D) mm
Weight	3 kg

### Soldering Iron

Tip to ground resistance	<2 Ω
Tip to ground potential	<2 mV
Heating element	IH (Induction heating)
Cord length	1.3 m
Total length*	190 mm with T31-02D24 or T31-03D24 tip 193 mm with T31-01D24 tip
Weight*	31 g (with T31-02D24 tip)

\* Without cord

Model No.	FX-1002
Temperature range	T35-02 Series: 400°C, T35-03 Series: 350°C
Tip to ground resistance	<2 Ω
Tip to ground potential	<2 mV
Heating element	IH (Induction heating)
Cord length	1.3 m
Total length*	166 mm (with T35-02D1 tip)
Weight*	21 g (with T35-02D1 tip)

\* Without cord

## FX-951 ESD SAFE

High Performance Soldering Station **Digital**

Tip not included

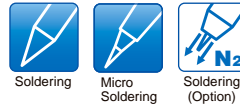

- Compact high-power thermally-controlled soldering iron
- Informs you of errors by a warning buzzer or display

## FX-950 ESD SAFE

High Performance Soldering Station **Analog**

Tip not included

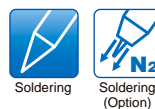

- Analog type high-power thermally-controlled soldering iron
- “Lock key” can lock the temperature setting.
- Informs you of various errors by a lamp

## Features

### Thermal recovery graph (comparison of HAKKO products)

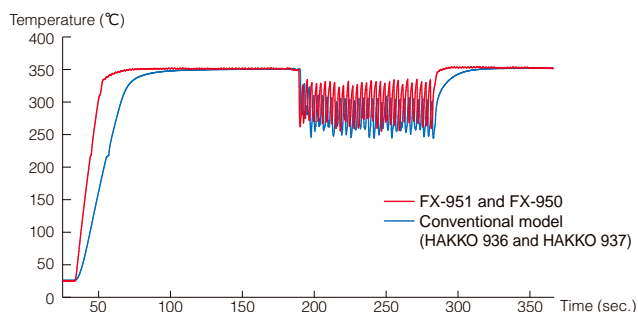

### Test criteria

Measurement method	A thermocouple is mounted on the tip and the tip temperature is measured when soldering $\varnothing 1.6$ mm $\times$ 5 mm solder to paper phenol copper board once every 3 seconds.
Board	Paper phenol copper board.
Temperature setting	350°C
Solder	Lead-free solder (Sn/Ag/Cu), diameter: 1.6 mm $\times$ 5 mm

### Connectable with micro soldering iron

For micro soldering applications under a microscope

## FM-2032 55W

### Micro Soldering Iron

Tip not included

Please see the optional tips on P.43.



N<sub>2</sub> Soldering is available with optional parts (P.39 & P.43).

### Connectable with N<sub>2</sub> soldering iron

To improve solder wettability and spreadability

## FM-2026 55W

### N<sub>2</sub> Soldering Iron

Tip not included

Please see the optional tips on P.43.



For further details, see the N<sub>2</sub> system (P.38 & P.39).

### Composite tip

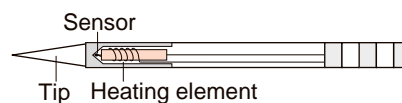

The composite tip with an integrated heating element and sensor offers superior thermal responsivity and thermal recovery.

## Specifications

Model No.	FX-951	FX-950
Power consumption	75 W	
Temperature range	200 to 450°C	
Temperature stability	±5°C at idle temperature	

### Station

Output voltage	AC 24 V
Dimensions	FX-951: 80 (W) $\times$ 130 (H) $\times$ 131 (D) mm FX-950: 80 (W) $\times$ 118 (H) $\times$ 138 (D) mm
Weight	1.2 kg

### Soldering Iron

Power consumption	70 W (24 V)
Tip to ground resistance	<2 $\Omega$
Tip to ground potential	<2 mV
Heating element	Composite heater
Cord length	1.2 m
Total length*	188 mm (with 2.4D tip)
Weight*	30 g (with 2.4D tip)

\* Without cord

Model No.	FM-2032	FM-2026
Power consumption	48 W (24 V)	70 W (24 V)
Temperature range	200 to 450°C	
Tip to ground resistance	<2 $\Omega$	
Tip to ground potential	<2 mV	
Heating element	Composite heater	
Cord length	1.3 m	1.2 m
Total length	170 mm* (with 1D tip)	205 mm** (with 2.4D tip)
Weight	14 g* (with 1D tip)	45 g** (with 2.4D tip and nozzle assembly C)

\* Without cord \*\* Without cord and tube \*\*\* Use FM-2026 below 400°C.

## Packing List

FX-951	Station, Handpiece (FM-2028), Control card, Power cord, Connecting cable, Heat resistant pad, Iron holder, Instruction manual
FX-950	Station, Handpiece (FM-2028), Lock key, Heat resistant pad, Iron holder, Instruction manual
FM-2032 (Conversion kit)	Handpiece, Heat resistant pad, Iron holder, Connecting cable, Instruction manual
FM-2026 (Conversion kit)	Handpiece, Sleeve cover, Sleeve assembly (yellow), Heat resistant pad, Iron holder, Connecting cable, Instruction manual

# Station Type and Accessories

## Optional Tips for FM-2028

Unit: mm

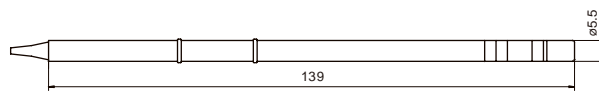

<b>B</b>	<b>T15-B Shape-B</b> 	<b>T15-B2 Shape-0.5B</b> 	<b>T15-B3 Shape-0.7B</b> 	<b>T15-B4 Shape-0.4B</b> 	<b>T15-BLL Shape-BLL</b> 
<b>BC</b>	<b>T15-BC1 Shape-1BC</b> <b>T15-BCF1*</b> 	<b>T15-BC2 Shape-2BC</b> <b>T15-BCF2*</b> 	<b>T15-BC3 Shape-3BC</b> <b>T15-BCF3*</b> 	<b>T15-BC12 Shape-1.2BC</b> 	<b>T15-BC15 Shape-1.5BC</b> 
	<b>T15-BC28 Shape-2.8BC</b> 	<b>T15-BCM2 Shape-2BC</b> <b>with indent</b> 	<b>T15-BCM3 Shape-3BC</b> <b>with indent</b> 	<b>T15-SBC04 Shape-0.4SBC</b> 	
<b>C</b>	<b>T15-C1 Shape-1C</b> 	<b>T15-CF2* Shape-2C</b> 	<b>T15-CF3* Shape-3C</b> 	<b>T15-C4 Shape-4C</b> <b>T15-CF4*</b> 	
<b>D</b>	<b>T15-D08 Shape-0.8D</b> 	<b>T15-D12 Shape-1.2D</b> 	<b>T15-D16 Shape-1.6D</b> 	<b>T15-D2 Shape-2D</b> 	<b>T15-D24 Shape-2.4D</b> 
	<b>T15-D32 Shape-3.2D</b> 	<b>T15-D4 Shape-4D</b> 	<b>T15-D52 Shape-5.2D</b> 	<b>T15-DL32 Shape-3.2DL</b> 	<b>T15-DL4 Shape-4DL</b> 
	<b>T15-DL52 Shape-5.2DL</b> 	<b>T15-XD15 Shape-1.5XD</b> 			
<b>I</b>	<b>T15-I Shape-I</b> 	<b>T15-IL Shape-IL</b> 	<b>T15-ILS Shape-ILS</b> 		
<b>J</b>	<b>T15-J02 Shape-0.2J</b> 	<b>T15-JD14 Shape-1.4JD</b> 	<b>T15-JD08 Shape-0.8JD</b> 	<b>T15-JD16 Shape-1.6JD</b> 	<b>T15-JL02 Shape-0.2JL</b> 
	<b>T15-JS02 Shape-0.2JS</b> 				

\*These tips are tinned on the soldering surface only.

K	<b>T15-K Shape-K</b> 	<b>T15-KF Shape-KF</b> 	<b>T15-KL Shape-KL</b> 	<b>T15-KU Shape-KU</b> 	
	<b>T15-R20 Shape-2R</b> 	<b>T15-R23 Shape-2.3R</b> 	<b>T15-R27 Shape-2.7R</b> 	<b>T15-R34 Shape-3.4R</b> 	<b>T15-R48 Shape-4.8R</b> 
SB	<b>T15-SB02 Shape-0.2SB</b> 	<b>T15-SB03 Shape-0.3SB</b> 	<b>T15-SB05 Shape-0.5SB</b> 	<b>T15-SB08 Shape-0.8SB</b> 	<b>T15-SBS04 Shape-0.4SBS</b> 
	<b>T15-SBS07 Shape-0.7SBS</b> 				
TUNNEL	<b>T15-1001** Tunnel 5.1 x 4.6</b> 	<b>T15-1002** Tunnel 5.1 x 10.4</b> 	<b>T15-1003** Tunnel 9.5 x 18.3</b> 	<b>T15-1004** Tunnel 9.5 x 15.8</b> 	<b>T15-1005** Tunnel 9.5 x 13.2</b> 
	<b>T15-1006** Tunnel 6.9 x 11.4</b> 	<b>T15-1007** Tunnel 7.9 x 18.8</b> 	<b>T15-1008** Tunnel 19.5 x 10.2</b> 	<b>T15-1009** Tunnel 13.4 x 20.5</b> 	<b>T15-1010** Tunnel 19.5 x 12</b> 
	<b>T15-1201** Quad 13.6 x 8.5</b> 	<b>T15-1202** Quad 10.3 x 10.3</b> 	<b>T15-1203** Quad 12.8 x 12.8</b> 	<b>T15-1204** Quad 17.9 x 17.9</b> 	<b>T15-1205** Quad 23.4 x 17.3</b> 
	<b>T15-1206** Quad 22.5 x 16.5</b> 	<b>T15-1207** Quad 15.5 x 15.5</b> 	<b>T15-1208** Quad 15.8 x 15.8</b> 	<b>T15-1209** Quad 8.4 x 8.4</b> 	<b>T15-1210** Quad 15.4 x 12.8</b> 
	<b>T15-1401** Spatula 10.4</b> 	<b>T15-1402** Spatula 15.7</b> 	<b>T15-1403** Spatula 21.2</b> 	<b>T15-1406** Spatula 40</b> 	
SPECIAL APPLICATIONS TYPE	<b>T15-1603** Shape-Long reach chisel</b> 	<b>T15-1605** Shape-Long reach bent chisel</b> 			

\* These tips are tinned on the soldering surface only.

\*\* The iron tips marked with double asterisk (\*\*) have a temperature accuracy of 25°C. Others have a temperature accuracy of 15°C.

## FM-203 ESD SAFE

2-Port High Performance Rework Station

Digital

Tip not included



- 2 handpieces can be connected at the same time.

## FM-206 ESD SAFE

3-Port High Performance Rework Station

Digital

Tip not included

Nozzle not included



- 3-port rework station that enables soldering, desoldering, and SMD rework all with a single unit
- Graphic LCD enables easy viewing and operation.

### Handpiece Combination Examples

FM-203



Handpiece	Channel D connector	Channel S connector
FM-2027	○	○
FM-2022 <sup>*1</sup>	○	×
FM-2023 <sup>*1</sup>	○	×
FM-2024 <sup>*2</sup>	○	○
FM-2026 <sup>*3</sup>	○	○
FM-2030 <sup>*1</sup>	○	×
FM-2031 <sup>*1 &amp; *3</sup>	○	×
FM-2032	○	○

\*1 When FM-2022, FM-2023, FM-2030 or FM-2031 is connected to the channel D connector, both channel connectors can't be used at the same time.  
 \*2 When two FM-2024s are connected to the channel connectors, each FM-2024 must be connected to the desolder control box.  
 \*3 For FM-2031 and FM-2026, each handpiece needs an N<sub>2</sub> generator (FX-780), flowmeter (FX-791), compressor, regulator, etc. For further details, see N<sub>2</sub> system (P.38 & P.39).

FM-206

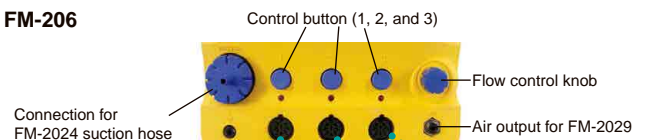

Handpiece	Receptacle 1	Receptacle 2	Receptacle 3
FM-2027	○	○	○
FM-2024	○ <sup>*1</sup>	○	○ <sup>*1</sup>
FM-2029	×	×	○
FM-2022	×	○	×
FM-2023	×	○	×
FM-2026	○	○	○
FM-2030	×	○	○
FM-2031	×	○ <sup>*2</sup>	○ <sup>*2</sup>
FM-2032	○	○	○

\*1 FM-2024 can be connected to receptacle 2 and 3. However, only one FM-2024 can be used with the station.  
 \*2 For FM-2031 and FM-2026, each handpiece needs an N<sub>2</sub> generator (FX-780), flowmeter (FX-791), compressor, regulator, etc. For further details, see N<sub>2</sub> system (P.38 & P.39).  
**NOTE:** FM-2024 and FM-2029 can't be used at the same time.

## Accessories

FM-2027 ESD

## Soldering Iron

Tip not included

FM-2026 ESDN<sub>2</sub> Soldering Iron

Tip not included

FM-2029 ESD

## Hot-Air Pencil

Nozzle not included

FM-2030 ESD

## Heavy Duty Soldering Iron

Tip not included

FM-2031 ESDN<sub>2</sub> Heavy Duty Soldering Iron

Tip not included

FM-2032 ESD

## Micro Soldering Iron

Tip not included

N<sub>2</sub> Soldering is available with optional parts (P.39 & P.43).FM-2022 ESD

## SMD Hot Tweezers

Tip not included

FM-2023 ESD

## Mini SMD Hot Tweezers

Tip included

FM-2024 ESD

## Desoldering Tool

Nozzle not included



# Station Type and Accessories

## Specifications

Model No.	FM-203
Power consumption	140 W
Temperature range	FM-2026/2027: 200 to 450°C FM-2022/2023: 200 to 400°C FM-2024: 350 to 450°C FM-2030/2031: 200 to 500°C FM-2032: 200 to 450°C
Temperature stability	±5°C at idle temperature

### Station

Output voltage	AC 24 V
Dimensions	120 (W) x 120 (H) x 190 (D) mm
Weight	2.7 kg

### Soldering Iron (FM-2027)

Power consumption	70 W (24 V)
Tip to ground resistance	<2 Ω
Tip to ground potential	<2 mV
Heating element	Composite heater
Cord length	1.2 m
Total length*	188 mm (with 2.4D tip)
Weight*	30 g (with 2.4D tip)

\* Without cord

Model No.	FM-206
Power consumption	410 W (450 W, max.)
Temperature range	FM-2026/2027: 200 to 450°C FM-2022/2023: 200 to 400°C FM-2024: 350 to 450°C FM-2029: 100 to 550°C FM-2030/FM-2031: 200 to 500°C FM-2032: 200 to 450°C
Temperature stability	±5°C at idle temperature

### Station

Output voltage	AC 24 V
Vacuum generator	Vacuum pump, cylinder type
Vacuum pressure	80 kPa (600 mmHg, max.)
Suction flow	14 L/min.
Air flow	6 L/min. (max.)
Dimensions	162 (W) x 136 (H) x 245 (D) mm
Weight*	6.2 kg

### Soldering Iron (FM-2027)

Power consumption	70 W (24 V)
Tip to ground resistance	<2 Ω
Tip to ground potential	<2 mV
Heating element	Composite heater
Cord length	1.2 m
Total length*	188 mm (with 2.4D tip)
Weight*	30 g (with 2.4D tip)

### Desoldering Tool (FM-2024)

Power consumption	70 W (24 V)
Nozzle to ground resistance	<2 Ω
Nozzle to ground potential	<2 mV
Heating element	Composite heater
Cord length	1.2 m
Total length*	180 mm (with ø1 mm nozzle)
Weight**	65 g (with ø1 mm nozzle)

### Hot Air Handpiece (FM-2029)

Power consumption	140 W (24 V)
Nozzle to ground resistance	<2 Ω
Nozzle to ground potential	<2 mV
Heating element	Composite heater
Cord length	1.2 m
Total length***	232 mm (with ø4 mm nozzle)
Weight***	50 g (with ø4 mm nozzle)

\* Without cord \*\* Without cord and hose \*\*\* Without cord and tube

Model No.	FM-2022
Power consumption	140 W (24 V)
Tip to ground resistance	<2 Ω
Tip to ground potential	<2 mV
Heating element	Composite heater
Cord length	1.2 m
Total length*	148 mm (with SOP 25L tip)
Weight*	64 g (with SOP 25L tip)

\* Without cord

Model No.	FM-2023
Power consumption	140 W (24 V)
Tip to ground resistance	<2 Ω
Tip to ground potential	<2 mV
Heating element	Composite heater
Standard tip	Shape-I: 2 pcs/set (No.T9-I)
Cord length	1.2 m
Total length*	117 mm (with I tip)
Weight*	37 g (with I tip)

\* Without cord

Model No.	FM-2024
-----------	---------

### Desoldering Tool

Power consumption	70 W (24 V)
Nozzle to ground resistance	<2 Ω
Nozzle to ground potential	<2 mV
Heating element	Composite heater
Cord length	1.2 m
Total length**	180 mm (with ø1 mm nozzle)
Weight**	65 g (with ø1 mm nozzle)

### Desolder Control Box

Power consumption	12 W (24 V)
Vacuum generator	Ejector type
Vacuum pressure	93 kPa (700 mmHg, max.)
Suction flow	20 L/min.
Nozzle to ground potential	<2 mV
Applied air pressure	490 kPa (5 kgf/cm <sup>2</sup> ) While in use (trigger or button is pressed)
Compressed air consumption	46 L/min.
Outer dimensions	119 (W) x 45 (H) x 172 (D) mm
Weight*	1.2 kg

\* Without cord \*\* Without cord and hose

Model No.	FM-2026
Power consumption	70 W (24 V)
Tip to ground resistance	<2 Ω
Tip to ground potential	<2 mV
Heating element	Composite heater
Cord length	1.2 m
Total length**	205 mm (with 2.4D tip)
Weight**	45 g (with 2.4D tip and nozzle assembly C)

\* Use this N<sub>2</sub> soldering iron below 400°C.

\*\* Without cord and tube

Model No.	FM-2027
Power consumption	70 W (24 V)
Tip to ground resistance	<2 Ω
Tip to ground potential	<2 mV
Heating element	Composite heater
Cord length	1.2 m
Total length*	188 mm (with 2.4D tip)
Weight*	30 g (with 2.4D tip)

\* Without cord



## Specifications

Model No.	FM-2030
Power consumption	140 W (24 V)
Tip to ground resistance	<2 Ω
Tip to ground potential	<2 mV
Heating element	Composite heater
Cord length	1.3 m
Total length*	224 mm (with 2.4D tip)
Weight*	41 g (with 2.4D tip)

\* Without cord

Model No.	FM-2032
Power consumption	48 W (24 V)
Tip to ground resistance	<2 Ω
Tip to ground potential	<2 mV
Heating element	Composite heater
Cord length	1.3 m
Total length*	170 mm (with 1D tip)
Weight*	14 g (with 1D tip)

\* Without cord

Model No.	FM-2031
Power consumption	140 W (24 V)
Tip to ground resistance	<2 Ω
Tip to ground potential	<2 mV
Heating element	Composite heater
Cord length	1.2 m
Total length*	231 mm (with 2.4D tip)
Weight*	47 g (with 2.4D tip and nozzle assembly E)

\* Without cord and tube

## Packing List

<b>FM-203</b>	Station, Handpiece (FM-2027), Sleeve assembly, Connecting cable, Power cord, Control card, Iron holder, Tip tray, Heat resistant pad, Instruction manual
<b>FM-206</b>	Station, Power cord, Tip tray, Desoldering tool (FM-2024), Handle (for gun configuration for FM-2024), Iron holder (for FM-2024), Ceramic paper filter (10 pcs; for FM-2024), Nozzle remover (for FM-2024), Cleaning drill for heating element (for FM-2024), Connecting cable (for FM-2024), Handpiece (FM-2027), Iron holder (for FM-2027), Heat resistant pad (for FM-2027), Connecting cable (for FM-2027), Hot air handpiece (FM-2029), Iron holder (for FM-2029), Heat resistant pad (for FM-2029), Connecting cable (for FM-2029), Instruction manual
<b>FM-2022 (Conversion kit)</b>	Parallel remover, Heat resistant pad, Iron holder, Connecting cable, Instruction manual
<b>FM-2023 (Conversion kit)</b>	Mini parallel remover, Soldering tip (T9-I), Heat resistant pad, Iron holder, Component bed, Connecting cable, Instruction manual

<b>FM-2024 (Conversion kit, with DCB)</b>	Desoldering tool, Handle (for gun configuration), Desoldering control box, Filter pipe assembly, Iron holder, Cleaning drill for heating element, Nozzle remover, Ceramic paper filter (10 pcs), Connecting cable, Instruction manual
<b>FM-2026 (Conversion kit)</b>	Handpiece, Sleeve cover, Sleeve assembly (yellow), Heat resistant pad, Iron holder, Connecting cable, Instruction manual
<b>FM-2027 (Conversion kit)</b>	Handpiece, Sleeve assembly (yellow), Heat resistant pad, Iron holder, Connecting cable
<b>FM-2029 (Conversion kit)</b>	Handpiece (hot air), Handpiece holder, Heat resistant pad, Connecting cable, Instruction manual
<b>FM-2030 (Conversion kit)</b>	Handpiece (soldering), Heat resistant pad, Iron holder, Connecting cable, Instruction manual
<b>FM-2031 (Conversion kit)</b>	Handpiece (soldering), Heat resistance pad, Iron holder, Connecting cable, Instruction manual
<b>FM-2032 (Conversion kit)</b>	Handpiece, Heat resistant pad, Iron holder, Connecting cable, Instruction manual

## FM-2029 Features

Securely and easily remove 10 × 10 (mm) chips.

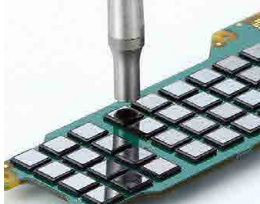

## FM-2032 Size

Unit: mm



## FM-2030 Features

Graph of a comparison of the performance of FM-2027 (70 W) and FM-2030 (140 W)

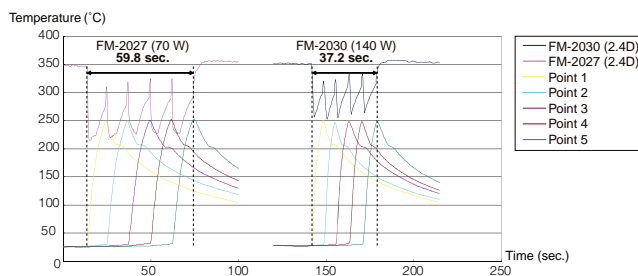

## Test criteria

Test method	Solder at 5 points and measure the time until the temperature of the workpiece reaches 250°C.
Board	Bakelite board
Component used	Screw
Tip shape	Shape-2.4D
Temperature setting	350°C
Solder	Lead-free solder (Sn/Ag/Cu), diameter: 1 mm

# Station Type and Accessories

## Optional Tips for FM-2027

Unit: mm



B	<b>T15-B Shape-B</b> 	<b>T15-B2 Shape-0.5B</b> 	<b>T15-B3 Shape-0.7B</b> 	<b>T15-B4 Shape-0.4B</b> 	<b>T15-BLL Shape-BL Long</b> 
	<b>T15-BC1 Shape-1BC</b> <b>T15-BCF1*</b> 	<b>T15-BC2 Shape-2BC</b> <b>T15-BCF2*</b> 	<b>T15-BC3 Shape-3BC</b> <b>T15-BCF3*</b> 	<b>T15-BC12 Shape-1.2BC</b> 	<b>T15-BC15 Shape-1.5BC</b> 
BC	<b>T15-BC28 Shape-2.8BC</b> 	<b>T15-BCM2 Shape-2BC with indent</b> 	<b>T15-BCM3 Shape-3BC with indent</b> 	<b>T15-SBC04 Shape-0.4SBC</b> 	
	<b>T15-C1 Shape-1C</b> 	<b>T15-CF2* Shape-2C</b> 	<b>T15-CF3* Shape-3C</b> 	<b>T15-C4 Shape-4C</b> <b>T15-CF4*</b> 	
D	<b>T15-D08 Shape-0.8D</b> 	<b>T15-D12 Shape-1.2D</b> 	<b>T15-D16 Shape-1.6D</b> 	<b>T15-D2 Shape-2D</b> 	<b>T15-D24 Shape-2.4D</b> 
	<b>T15-D32 Shape-3.2D</b> 	<b>T15-D4 Shape-4D</b> 	<b>T15-D52 Shape-5.2D</b> 	<b>T15-DL32 Shape-3.2DL</b> 	<b>T15-DL4 Shape-4DL</b> 
	<b>T15-DL52 Shape-5.2DL</b> 	<b>T15-XD15 Shape-1.5XD</b> 			
I	<b>T15-I Shape-I</b> 	<b>T15-IL Shape-IL</b> 	<b>T15-ILS Shape-ILS</b> 		
	<b>T15-J02 Shape-0.2J</b> 	<b>T15-JD14 Shape-1.4JD</b> 	<b>T15-JD08 Shape-0.8JD</b> 	<b>T15-JD16 Shape-1.6JD</b> 	<b>T15-JL02 Shape-0.2JL</b> 
J	<b>T15-JS02 Shape-0.2JS</b> 				

\*These tips are tinned on the soldering surface only.

K	<b>T15-K Shape-K</b> 	<b>T15-KF Shape-KF</b> 	<b>T15-KL Shape-KL</b> 	<b>T15-KU Shape-KU</b> 		
	<b>T15-R20 Shape-2R</b> 	<b>T15-R23 Shape-2.3R</b> 	<b>T15-R27 Shape-2.7R</b> 	<b>T15-R34 Shape-3.4R</b> 	<b>T15-R48 Shape-4.8R</b> 	
SB	<b>T15-SB02 Shape-0.2SB</b> 	<b>T15-SB03 Shape-0.3SB</b> 	<b>T15-SB05 Shape-0.5SB</b> 	<b>T15-SB08 Shape-0.8SB</b> 	<b>T15-SBS04 Shape-0.4SBS</b> 	
	<b>T15-SBS07 Shape-0.7SBS</b> 					
TUNNEL	<b>T15-1001** Tunnel 5.1 x 4.6</b> 	<b>T15-1002** Tunnel 5.1 x 10.4</b> 	<b>T15-1003** Tunnel 9.5 x 18.3</b> 	<b>T15-1004** Tunnel 9.5 x 15.8</b> 	<b>T15-1005** Tunnel 9.5 x 13.2</b> 	
	<b>T15-1006** Tunnel 6.9 x 11.4</b> 	<b>T15-1007** Tunnel 7.9 x 18.8</b> 	<b>T15-1008** Tunnel 19.5 x 10.2</b> 	<b>T15-1009** Tunnel 13.4 x 20.5</b> 	<b>T15-1010** Tunnel 19.5 x 12</b> 	
	<b>T15-1201** Quad 13.6 x 8.5</b> 	<b>T15-1202** Quad 10.3 x 10.3</b> 	<b>T15-1203** Quad 12.8 x 12.8</b> 	<b>T15-1204** Quad 17.9 x 17.9</b> 	<b>T15-1205** Quad 23.4 x 17.3</b> 	
	<b>T15-1206** Quad 22.5 x 16.5</b> 	<b>T15-1207** Quad 15.5 x 15.5</b> 	<b>T15-1208** Quad 15.8 x 15.8</b> 	<b>T15-1209** Quad 8.4 x 8.4</b> 	<b>T15-1210** Quad 15.4 x 12.8</b> 	
	SPATULA	<b>T15-1401** Spatula 10.4</b> 	<b>T15-1402** Spatula 15.7</b> 	<b>T15-1403** Spatula 21.2</b> 	<b>T15-1406** Spatula 40</b> 	
<b>SPECIAL APPLICATIONS TYPE</b>						
<b>T15-1603** Shape-Long reach chisel</b> 		<b>T15-1605** Shape-Long reach bent chisel</b> 				
* These tips are tinned on the soldering surface only. ** The iron tips marked with double asterisk (**) have a temperature accuracy of 25°C. Others have a temperature accuracy of 15°C.						

# Station Type and Accessories

## Optional Tips for FM-2032

Unit: mm

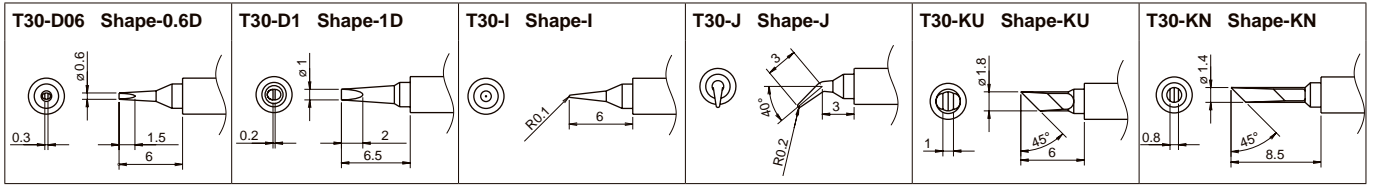

## Optional Tips for FM-2022

Unit: mm

### CHIP

\*1 set: 2 pcs

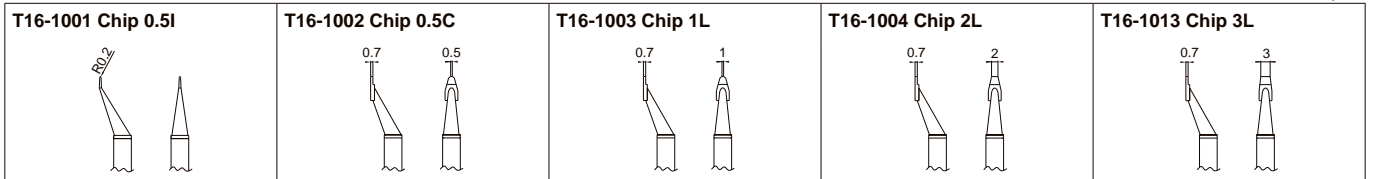

### SOP

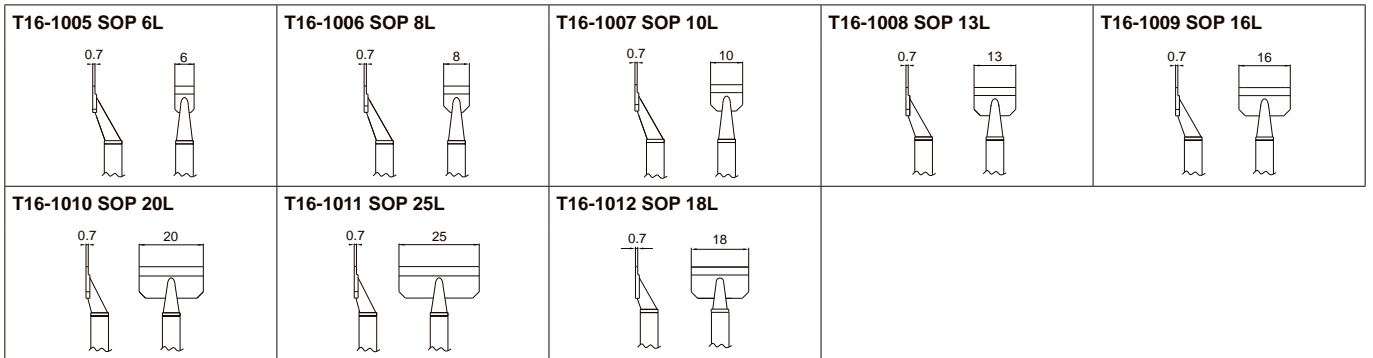

## Replacement Tips for FM-2023

Unit: mm

### CHIP

\*1 set: 2 pcs

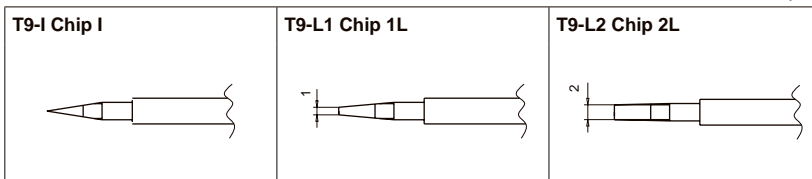

## Optional Tips for FM-2030

Unit: mm

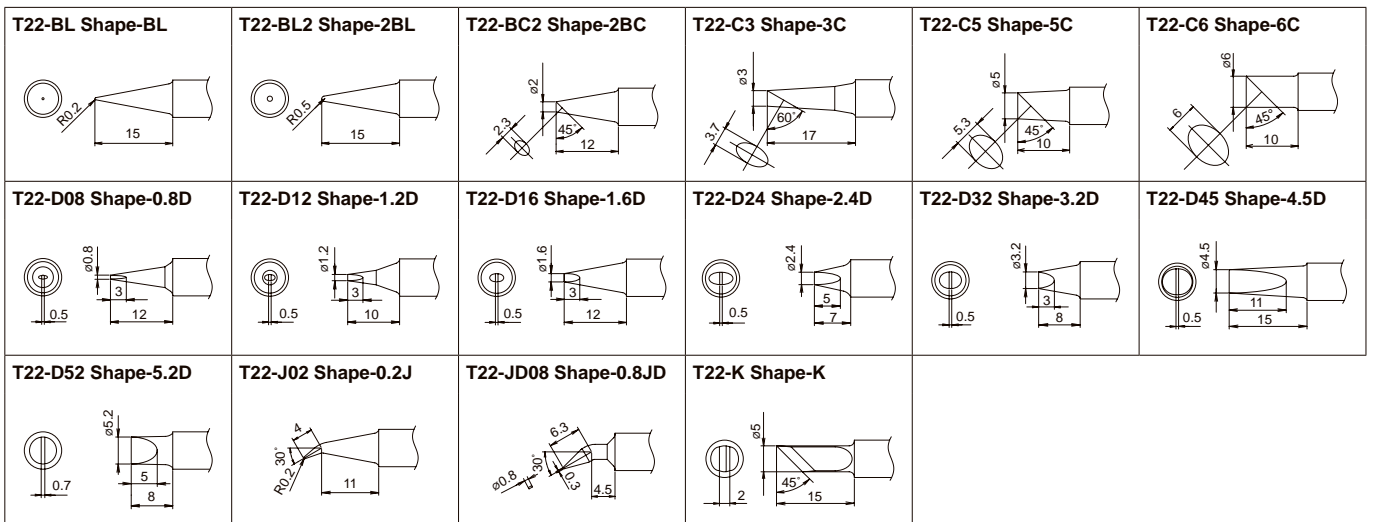

**Optional Nozzles for FM-2024**

Unit: mm

<p><b>N3-06 Nozzle <math>\phi 0.6</math></b></p>	<p><b>N3-08 Nozzle <math>\phi 0.8</math></b></p>	<p><b>N3-10 Nozzle <math>\phi 1</math></b></p>	<p><b>N3-13 Nozzle <math>\phi 1.3</math></b></p>	<p><b>N3-16 Nozzle <math>\phi 1.6</math></b></p>
<p><b>N3-20 Nozzle <math>\phi 2</math></b></p>	<p><b>N3-23 Nozzle <math>\phi 2.3</math></b></p>	<p><b>N3-L10 Nozzle <math>\phi 1</math> long</b></p>		

**Optional Nozzles for FM-2029**

Unit: mm

		$\phi A$	$\phi B$
<b>N4-01 Nozzle <math>\phi 2</math></b>		2	2.5
<b>N4-02 Nozzle <math>\phi 4</math></b>		4	5
<b>N4-03 Nozzle <math>\phi 6</math></b>		6	7
<b>N4-04 Nozzle <math>\phi 8</math></b>		8	9

**Optional Tips for FM-2026**

Please see the optional tips on P.43.

**Optional Tips for FM-2031**

Please see the optional tips on P.42.

# Station Type and Accessories

## FX-801 ESD SAFE

Heavy Duty Soldering Station **Digital**

Tip not included



- Super power 300 W
- Best suited for soldering P.W.B. with high heat capacity and high heat dissipation property

### Optional Tips for FX-8002

Unit: mm

#### Regular type

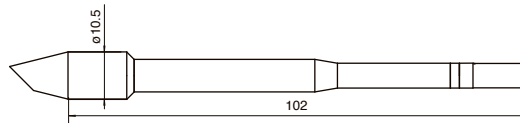

<b>T33-BC2 Shape-2BC</b> 	<b>T33-BC3 Shape-3BC</b> 	<b>T33-BC4 Shape-4BC</b> 	<b>T33-BC5 Shape-5BC</b> 	<b>T33-BC6 Shape-6BC</b> 	<b>T33-D24 Shape-2.4D</b> 
<b>T33-D32 Shape-3.2D</b> 	<b>T33-D5 Shape-5D</b> 	<b>T33-D6 Shape-6D</b> 	<b>T33-1610</b> 	<b>T33-1611</b> 	

#### Slim type

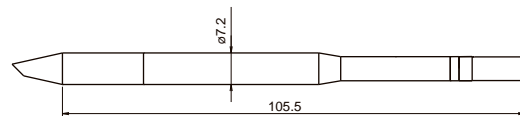

<b>T33-SSBC2 Shape-2SSBC</b> 	<b>T33-SSBC3 Shape-3SSBC</b> 	<b>T33-SSBC4 Shape-4SSBC</b> 	<b>T33-SSBC5 Shape-5SSBC</b> 	<b>T33-SSD16 Shape-1.6SSD</b> 	<b>T33-SSD24 Shape-2.4SSD</b> 
<b>T33-SSD32 Shape-3.2SSD</b> 	<b>T33-SSD6 Shape-6SSD</b> 	<b>T33-SS1610</b> 	<b>T33-SS1611</b> 		

## Features

### Make the impossible possible with Super Power of 300 W Heater



Check out the powerful performance of FX-801 easily melting a bar solder.



For further details,  
please scan here.

**Compact and lightweight (50 g) for heavy duty 300 W iron**  
The same weight as the iron part of FX-838, 150 W soldering station, for operator's comfort and better workability.

### A wide variety of tip shapes

#### • Regular type

Best suited for components with high thermal mass such as transformers and coils.

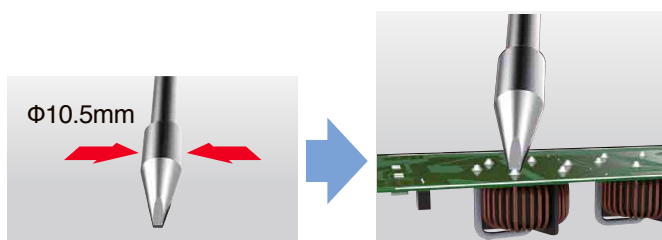

#### • Slim type

Slimmed-down tips for narrow spaces without losing of enough power.

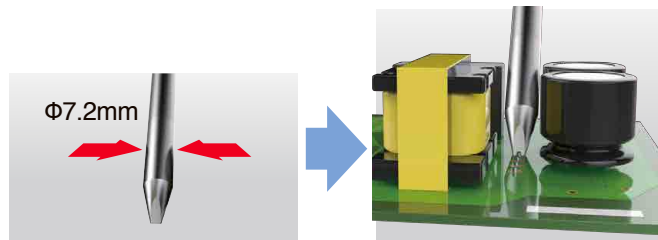

### Connectable with N<sub>2</sub> soldering iron

To improve solder wettability and spreadability

## FX-8003 55W

### N<sub>2</sub> Soldering Iron

Tip not included

Please see the optional tips on P.41.



For further details, see the N<sub>2</sub> system (P.38 & P.39).

### Packing List

FX-801	Station, Handpiece (FX-8002), Heat resistant pad, Power cord, Connecting cable, Iron holder (with cleaning wire), Instruction manual
FX-8003	Handpiece, Instruction manual

### Specifications

Model No.	FX-801
Power consumption	300 W
Temperature range	50 to 500°C
Temperature stability	±5°C at idle temperature

#### Station

Output voltage	AC 29 V
Dimensions	145 (W) × 107 (H) × 211 (D) mm
Weight	3.9 kg

#### Soldering Iron

Power consumption	260 W (29 V)
Tip to ground resistance	<2 Ω
Tip to ground potential	<2 mV
Heating element	Composite heater
Cord length	1.2 m
Total length*	228 mm (with 4BC tip)
Weight*	50 g (with 4BC tip)

\* Without cord

Model No.	FX-8003
Power consumption	260 W (29 V)
Temperature range	50 to 500°C
Tip to ground resistance	<2 Ω
Tip to ground potential	<2 mV
Heating element	Composite heater
Cord length	1.2 m
Total length*	253 mm (with 4BC tip)
Weight*	65 g (with 4BC tip and nozzle assembly A)

\* Without cord and tube

## FX-838 ESD SAFE

Heavy Duty Soldering Iron **Digital**

Tip not included



- High powered 150 W soldering iron
- Best suited for soldering of power-supply boards, heat sinks, and shield cases
- Applicable also to the soldering of multilayer boards with micro components

### Optional Tips for FX-8301

Unit: mm

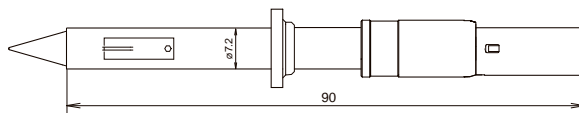

<b>T20-B2 Shape-0.5B</b> 	<b>T20-BC2 Shape-2BC T20-BCF2*</b> 	<b>T20-BC3 Shape-3BC T20-BCF3*</b> 	<b>T20-BC4 Shape-4BC T20-BCF4*</b> 	<b>T20-BCM2 Shape-2BC with indent</b> 
<b>T20-BCM3 Shape-3BC with indent</b> 	<b>T20-BL Shape-BL</b> 	<b>T20-BL2 Shape-2BL</b> 	<b>T20-BL3 Shape-3BL</b> 	<b>T20-C5 Shape-5C</b> 
<b>T20-C6 Shape-6C</b> 	<b>T20-D16 Shape-1.6D</b> 	<b>T20-D24 Shape-2.4D</b> 	<b>T20-D32 Shape-3.2D</b> 	<b>T20-D6 Shape-6D</b> 
<b>T20-J02 Shape-0.2J</b> 	<b>T20-K Shape-K</b> 	<b>T20-KU Shape-KU</b> 	<b>T20-1610</b> 	<b>T20-1611</b> 

\* These tips are tinned on the soldering surface only.



## Features

### Graph of a comparison of the performance of FX-838 and a conventional station

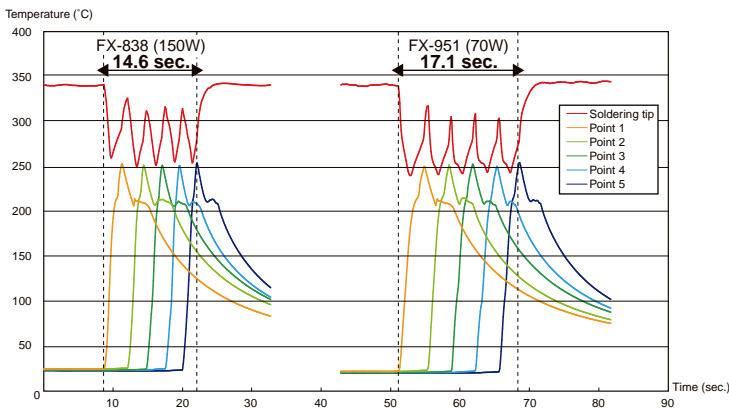

#### Test criteria

Measurement method	Thermocouples are mounted on the tip and the soldered portion on the board, and the time until the soldered portion reaches 250°C is measured for 5 points.
Board	Bakelite board
Component used	Terminal
Tip shape	Shape-1.6D
Temperature setting	340°C
Solder	Lead-free solder (Sn/Ag/Cu), diameter: 0.5 mm

### Temperature preset mode

The temperature preset mode allows you to input three frequently-used temperatures in advance and recall them with one push of a button.

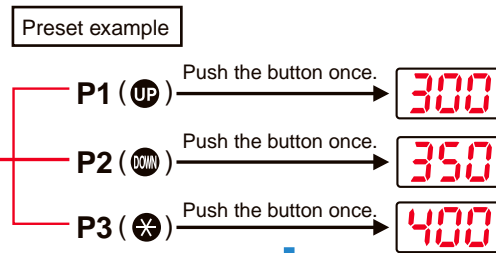

One push of a button can quickly recall each setting.

### Connectable with N<sub>2</sub> soldering iron

To improve solder wettability and spreadability

## FX-8302 ESD SAFE

### N<sub>2</sub> Soldering Iron

**Tip not included** Please see the optional tips on P.42.



For further details, see the N<sub>2</sub> system (P.38 & P.39).

### Packing List

<b>FX-838</b>	Station, Handpiece (FX-8301), Control card, Power cord, Heat resistant pad, Connecting cable, Iron holder, Instruction manual
<b>FX-8302</b>	Handpiece, Instruction manual

### Specifications

Model No.	FX-838
Power consumption	158 W
Temperature range	200 to 500°C
Temperature stability	±5°C at idle temperature

#### Station

Output voltage	AC 27 V
Dimensions	110 (W) × 110 (H) × 205 (D) mm
Weight	3.2 kg

#### Soldering Iron

Power consumption	150 W (27 V)
Tip to ground resistance	<2 Ω
Tip to ground potential	<2 mV
Heating element	Ceramic heater
Cord length	1.2 m
Total length*	175 mm (with 2.4D tip)
Weight*	31 g (with 2.4D tip)

\* Without cord

Model No.	FX-8302
Power consumption	150 W (27 V)
Temperature range	200 to 500°C
Tip to ground resistance	<2 Ω
Tip to ground potential	<2 mV
Heating element	Ceramic heater
Cord length	1.2 m
Total length*	195 mm (with 2.4D tip)
Weight*	41 g (with 2.4D tip and nozzle assembly D)

\* Without cord and tube

## FX-888D ESD SAFE

All-Round Soldering Station **Digital**

Tip included

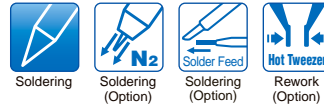

- Features Adjustment mode, Preset mode, and Password function
- Separable tip/heater design provides superior cost performance.
- L type (large type) soldering iron FX-8805 is added to the lineup.

## FX-889 ESD SAFE

2-Port All-Round Soldering Station **Digital**

Tip included

\* 1 piece of FX-8801 is included as standard.

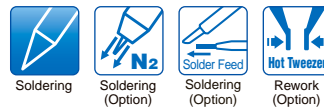

- All the user-friendly functions are succeeded from FX-888D.
- Two applications can be active at the same time.
- Applicable to all the options, N<sub>2</sub> soldering iron, Soldering gun, SMD Hot Tweezers, and L type (large type) soldering iron.

## Common features

### Strict temperature management

#### ● Digital display

FX-888D's and FX-889's digital display makes it easy to check the set temperature at a glance.

#### ● Password function

Settings can be locked using a password to prevent them from being changed unexpectedly.

#### ● Preset mode

Simply select the desired temperature from a selection of preset temperatures registered in advance. (up to 5 preset temperatures can be registered.)

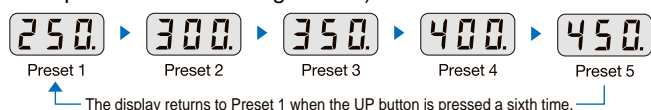

#### ● Adjustment mode

With adjustment mode, what used to be a troublesome procedure is now as simple as entering the measured tip temperature in FX-888D and FX-889.

#### ● FX-888D and FX-889 deliver excellent thermal recovery by using T18 and T19 series tips for their terrific heat conductivity.

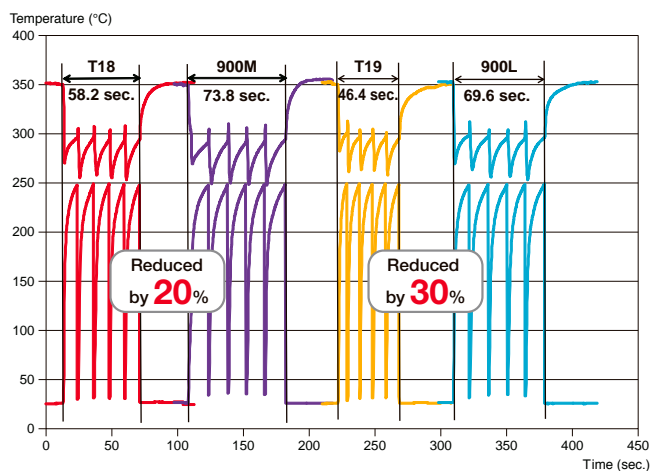

### Test criteria

Measurement method	Thermocouples are mounted on the tip and the soldered portion on the board, and the time until the soldered portion reaches 250°C is measured for 5 points.
Board	Paper phenol copper board
Component used	Terminal
Tip shape	Shape-2.4D
Temperature setting	350°C
Solder	Lead-free solder (Sn/Ag/Cu), diameter: 0.5 mm



Measuring the tip temperature with a tip thermometer (FG-100B)

## Packing List

FX-888D	Station, Handpiece (FX-8801), Iron holder, Instruction manual
FX-889	Station, Handpiece (FX-8801), Power cord, Dual Iron Holder, Color band (qty 2), Instruction Manual

## Specifications

Model No.	FX-888D	FX-889
Power consumption	70 W	135 W
Temperature range	50 to 480°C	50 to 480°C
Temperature stability	±1°C at idle temperature (when set to 200 to 480°C)	

### Station

Output voltage	AC 26 V	AC 26 V
Dimensions	100 (W) × 120 (H) × 120 (D) mm	157 (W) × 121 (H) × 149 (D) mm
Weight	1.2 kg*	2.1 kg

### Soldering Iron

Power consumption	65 W (26 V)	65 W (26 V)
Tip to ground resistance	<2 Ω	<2 Ω
Tip to ground potential	<2 mV	<2 mV
Heating element	Ceramic heater	Ceramic heater
Standard tip	Shape-B (No.T18-B)	Shape-B (No.T18-B)
Cord length	1.2 m	1.2 m
Total length*	217 mm (with B tip)	217 mm (with B tip)
Weight*	46 g (with B tip)	46 g (with B tip)

\* Without cord

# Station Type and Accessories

## Features of FX-889

### User-Friendly Design

#### ● Space-saving design

The reduced foot print is smaller than 2 of FX-888D and its iron holder. Efficient setup is available even on smaller workbench.

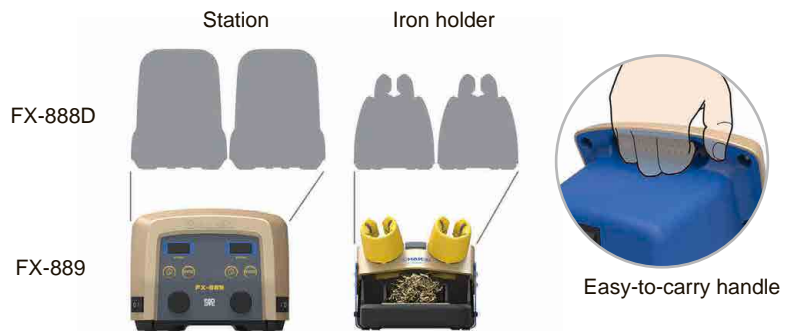

#### ● Power-saving design

Independent switches cut the power for each iron when not in use. Power-saving design minimizes standby electricity.

#### ● Superior operability

Four buttons were symmetrically placed at the both sides on the front panel. The two buttons on each side allow simple and intuitive operation.

A color band can be attached to the handle, and this makes it possible to see at a glance which side it is connected to. (2 pieces of color band are included as the standard accessories.)



#### ● Rich functions of iron holder

- Convenient pockets to stock soldering tips
- Three different ways for tip cleaning with provided cleaning tools
- Simple and easy cleaning of iron holder inside by removing holder base

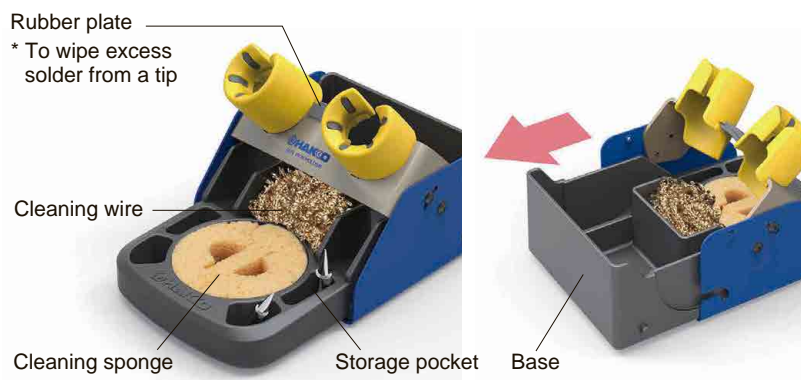

**FX-8801** ESD SAFE**Soldering Iron M type**

Tip included

**FX-8802** ESD SAFE**N<sub>2</sub> Soldering Iron**

Tip included

**FX-8803** ESD SAFE**Soldering Gun**

Tip included

**FX-8804** ESD SAFE**SMD Hot Tweezers**

Tip included

**FX-8805** ESD SAFE**Soldering Iron L type**

Tip included

**Specifications**

Model No.	FX-8801
Power consumption	65 W (26 V)
Temperature range	50 to 480°C
Tip to ground resistance	<2 Ω
Tip to ground potential	<2 mV
Heating element	Ceramic heater
Standard tip	Shape-B (No.T18-B)
Cord length	1.2 m
Total length*	217 mm (with B tip)
Weight*	46 g (with B tip)

\* Without cord

Model No.	FX-8802
Power consumption	65 W (26 V)
Temperature range	50 to 480°C
Tip to ground resistance	<2 Ω
Tip to ground potential	<2 mV
Heating element	Ceramic heater
Standard tip	Shape-B (No.T18-B)
Cord length	1.2 m
Total length**	190 mm (with B tip)
Weight**	59 g (with B tip and nozzle assembly A)

\* Use this N<sub>2</sub> soldering iron below 450°C.

\*\* Without cord and tube

Model No.	FX-8803
Power consumption	65 W (26 V)
Temperature range	50 to 480°C
Tip to ground resistance	<2 Ω
Tip to ground potential	<2 mV
Heating element	Ceramic heater
Standard tip	Shape-3C pre-tinned surface 45° (No.T18-CF3)
Standard guide nozzle	ø1 mm
Usable solder diameter	0.6, 0.8, 1, 1.2, 1.6 mm
Cord length	1.1 m
Dimensions	170 (W) × 180 (H) × 23 (D) mm
Weight*	207 g

\* Without cord

Model No.	FX-8804
Power consumption	65 W (26 V)
Temperature range	200 to 400°C
Tip to ground resistance	<2 Ω
Tip to ground potential	<2 mV
Heating element	Ceramic heater
Standard tip	Shape-2L (No. A1378) 2 pcs/set
Cord length	1.2 m
Total length**	186 mm
Weight**	93 g

\* The recommended (process) temperature is from 200°C to 400°C while setting temperature range of FX-888D is from 50°C to 480°C.

\*\* Without cord

Model No.	FX-8805
Power consumption	65 W (26 V)
Temperature range	50 to 480°C
Tip to ground resistance	<2 Ω
Tip to ground potential	<2 mV
Heating element	Ceramic heater
Standard tip	Shape-B (No.T19-B)
Cord length	1.2 m
Total length*	222 mm (with B tip)
Weight*	52 g (with B tip)

\* Without cord

# Station Type and Accessories

## Packing List

<b>FX-8801</b>	Handpiece, Instruction Manual
<b>FX-8802</b>	Handpiece, Shield plate, Instruction manual
<b>FX-8803</b>	Handpiece, Instruction manual
<b>FX-8804</b>	Handpiece, Caution label, Heat resistant pad, Instruction manual
<b>FX-8805</b>	Handpiece, Instruction Manual

NOTE: The soldering iron cannot be used as a standalone device.

## Option

### FX-8803

Part No.	Name	Specifications
C1437	Iron holder (with cleaning sponge)	-

### FX-8804

Part No.	Name	Specifications
FH800-04BY	Iron holder (with cleaning sponge)	Blue & yellow

### FX-8801 & FX-8805

Part No.	Name	Specifications
B5122	Tip enclosure	With nut, required when converting from FX-8801 to FX-8805
B3730	Nut and tip enclosure	Required when converting from FX-8805 to FX-8801

## Replacement Tips for FX-8801 and FX-8803

Unit: mm

<p>Applicable for FX-8803</p> <p><b>T18-B Shape-B</b></p>	<p>Applicable for FX-8803</p> <p><b>T18-SB Shape-SB</b></p>	<p><b>T18-BR02 Shape-0.2BR</b></p>	<p><b>T18-BL Shape-BL</b></p>	<p><b>T18-C05 Shape-0.5C</b></p>
<p>Applicable for FX-8803</p> <p><b>T18-C08 Shape-0.8C</b></p>	<p>Applicable for FX-8803 (Only C1)</p> <p><b>T18-C1 Shape-1C</b> <b>T18-CF1*</b></p>	<p><b>T18-CF15* Shape-1.5C</b></p>	<p>Applicable for FX-8803</p> <p><b>T18-C2 Shape-2C</b> <b>T18-CF2*</b></p>	<p>Applicable for FX-8803</p> <p><b>T18-CSF25* Shape-2.5CS</b></p>
<p>Applicable for FX-8803</p> <p><b>T18-C3 Shape-3C</b> <b>T18-CF3*</b></p>	<p>Applicable for FX-8803</p> <p><b>T18-C4 Shape-4C</b> <b>T18-CF4*</b></p>	<p>Applicable for FX-8803</p> <p><b>T18-C5 Shape-5C</b></p>	<p>Applicable for FX-8803</p> <p><b>T18-K Shape-K</b></p>	<p>Applicable for FX-8803</p> <p><b>T18-D08 Shape-0.8D</b></p>
<p>Applicable for FX-8803</p> <p><b>T18-D12 Shape-1.2D</b></p>	<p>Applicable for FX-8803</p> <p><b>T18-D16 Shape-1.6D</b></p>	<p>Applicable for FX-8803</p> <p><b>T18-D24 Shape-2.4D</b></p>	<p>Applicable for FX-8803</p> <p><b>T18-D32 Shape-3.2D</b></p>	<p><b>T18-DL12 Shape-1.2DL</b></p>
<p><b>T18-DL2 Shape-2DL</b></p>	<p><b>T18-DL32 Shape-3.2DL</b></p>	<p><b>T18-S3 Shape-S3</b></p>	<p>Applicable for FX-8803</p> <p><b>T18-S4 Shape-S4</b></p>	<p><b>T18-S6 Shape-S6</b></p>
<p>Applicable for FX-8803</p> <p><b>T18-S9 Shape-S9</b></p>	<p>Applicable for FX-8803</p> <p><b>T18-I Shape-I</b></p>			

\* These tips are tinned on the soldering surface only.

### Replacement Tips and Nozzles for FX-8802

Please see the replacement tips on P.43.

### Replacement Tips for FX-8804

#### For Chip Component

Part No.	Name	Size of A (B)	Tip Shape
A1577	Tip/CHIP 0.5L	0.5 mm	
A1379	Tip/CHIP 1L	1 mm	
A1378	Tip/CHIP 2L	2 mm	
A1388	Tip/CHIP 0.5C	1.5 (0.5) mm	
A1389	Tip/CHIP 0.5I	R0.25 mm	
A1576	Tip/CHIP 2.6C	2.6 mm	

#### For SOP Component

Part No.	Name	Size of A	Tip Shape
A1390	Tip/SOP 4L	4 mm	
A1391	Tip/SOP 6L	6 mm	
A1380	Tip/SOP 8L	8 mm	
A1381	Tip/SOP 10L	10 mm	
A1382	Tip/SOP 13L	13 mm	
A1392	Tip/SOP 15L	15 mm	
A1383	Tip/SOP 18L	18 mm	
A1384	Tip/SOP 20L	20 mm	
A1385	Tip/SOP 25L	25 mm	

### Replacement Tips for FX-8805

Unit: mm

<b>T19-B Shape-B</b> 	<b>T19-B2 Shape-2B</b> 	<b>T19-C3 Shape-3C</b> 	<b>T19-C4 Shape-4C</b> 	<b>T19-C65 Shape-6.5C</b> 
<b>T19-D24 Shape-2.4D</b> 	<b>T19-D32 Shape-3.2D</b> 	<b>T19-D5 Shape-5D</b> 	<b>T19-D65 Shape-6.5D</b> 	<b>T19-I Shape-I</b> 



## FX-780 / FX-781

### N<sub>2</sub> Generator



- Highest concentration of nitrogen gas: 99.9%
- Compact design reduces footprint.
- Large-capacity type accepts 2 soldering irons (FX-781).

## FX-791

### N<sub>2</sub> Flowmeter



- Flowmeter for N<sub>2</sub> soldering iron with flow control valve and regulator

- The preheating effect is achieved by passing nitrogen gas along the heating element in the hand piece.
- Improvement of wettability and spreadability
- Preventing oxidation

### Connection Method

#### For two soldering irons

Large-capacity type : FX-781

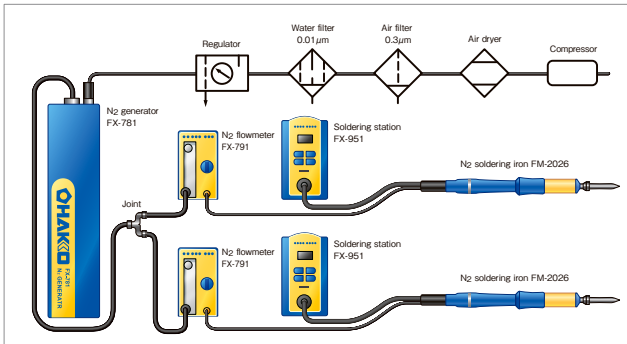

\* It is capable to supply high concentration nitrogen of 97% at the output rate approx. 1L/min. (at air supply pressure of 0.5MPa)

#### For one soldering iron

Small-capacity type : FX-780  
Large-capacity type : FX-781

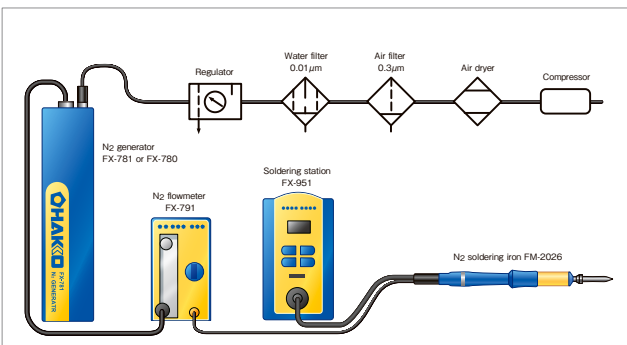

\* It is capable to supply high concentration nitrogen of 99.9% at the output rate approx. 1L/min. (at air supply pressure of 0.7MPa)

### Specifications

Model No.	FX-780	FX-781
Air supply pressure	0.3 to 0.7 MPa	
Concentration of generated N <sub>2</sub>	99.9% (max.)	
Amount of generated N <sub>2</sub>	1.5 L/min. (When compressed air of 0.5 MPa is supplied at 25°C, the concentration of the generated nitrogen is 98%.)	2.4 L/min. (When compressed air of 0.5 MPa is supplied at 25°C, the concentration of the generated nitrogen is 98%.)
Dimensions*	73 (W) x 282 (H) x 71 (L) mm	73 (W) x 407 (H) x 71 (L) mm
Weight**	1.5 kg	2 kg

\* Without sockets and valve  
\*\* Without racks

Model No.	FX-791
Pressure of discharged gas	0.2 MPa (2 kgf/cm <sup>2</sup> )
Gas flow	0.25 to 2.5 L/min.
Dimensions	70 (W) x 121 (H) x 134 (D) mm
Weight	600 g

### Packing List

FX-780	Unit, Rack for unit (2 pcs), Instruction manual
FX-781	Unit, Racks for unit (4 pcs), Instruction manual
FX-791	Unit, Instruction manual



## Effects of N<sub>2</sub> system

N<sub>2</sub> gas is heated inside soldering iron and is discharged from the tip end. It prevents soldering joint from oxidation and gives preheating effect to workpiece. As a result, solderability increases.



### Preventing oxidation

Heated N<sub>2</sub> gas reduces the oxidation of tips (iron plating). As a result, the wettability of tips is improved.



#### Test criteria

After applying power for 3 hours with the temperature set at 400°C, feed solder and perform cleaning, and then compare the conditions.

### Preheating effect

Heated N<sub>2</sub> gas preheats the workpiece. As a result, even if the temperature setting is low, soldering can be finished in the same time as before.

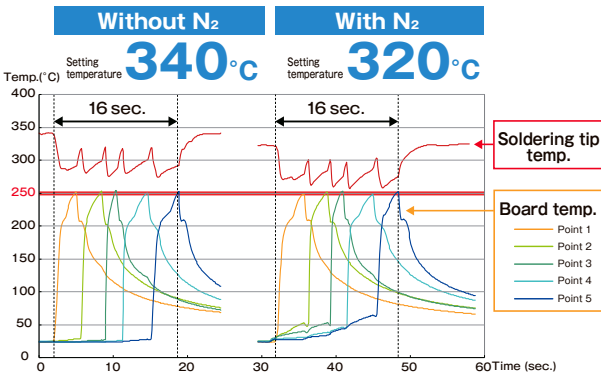

#### Test criteria

Board: Paper phenol copper board  
Component: Connector  
Solder: Lead-free solder (Sn-3Ag-0.5Cu)  $\phi$ 0.5mm  
Tip shape: T12-D24 and T13-D24  
Measurement method: Measure the time until the workpiece reached to 250°C at 5-points

- Compatible with no-clean soldering (low-activity flux)
- Solves the insufficient heat supply problems which may occur during soldering of multilayer boards
- Reduces cracking in multilayer ceramic capacitors by thermal stress
- Reduces soldering time
- Relieves loads applied to heat-sensitive parts
- Reduces tip oxidation

The use of N<sub>2</sub> gas improves workability, quality stability and reduces running cost.

## Applicable Soldering Station

	N <sub>2</sub> Soldering Iron	Soldering Station
IoT Capable	FN-1102 <b>95 W</b>	FN-1010
Heavy Duty	FX-8003 <b>260 W</b>	FX-801
	FX-8302 <b>150 W</b>	FX-838
High Performance	FM-2031 <b>140 W</b>	FM-206    FM-203
	FM-2032 <b>48 W</b>	FX-951    FM-206    FM-203
	FM-2026 <b>70 W</b>	FX-951    FM-206    FM-203 FM-204    FX-950
All-Round	FX-8802 <b>65 W</b>	FX-888D    FX-889

\* Use FM-2026 below 400°C.  
\* Use FX-8802 below 450°C.

## Optional Tips and Nozzle Assemblies for FN-1102

Tip and nozzle assembly are supplied separately. Please purchase a compatible nozzle assembly for your tip referring the chart below.

Unit: mm

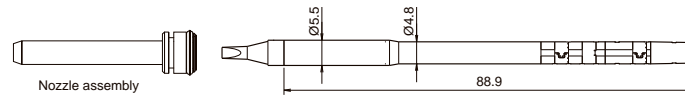

<b>T36-B Shape-0.2B</b> 	<b>T36-B2 Shape-0.5B</b> 	<b>T36-BL Shape-BL</b> 	<b>T36-BC1 Shape-1BC</b> 	<b>T36-BC2 Shape-2BC</b> 
B5233 Nozzle assembly A	B5234 Nozzle assembly B	B5234 Nozzle assembly B	B5235 Nozzle assembly C	B5234 Nozzle assembly B
<b>T36-BC3 Shape-3BC</b> 	<b>T36-C1 Shape-1C</b> 	<b>T36-C4 Shape-4C</b> 	<b>T36-D08 Shape-0.8D</b> 	<b>T36-D16 Shape-1.6D</b> 
B5236 Nozzle assembly D	B5235 Nozzle assembly C	B5236 Nozzle assembly D	B5233 Nozzle assembly A	B5233 Nozzle assembly A
<b>T36-D24 Shape-2.4D</b> 	<b>T36-DL32 Shape-3.2DL</b> 	<b>T36-D52 Shape-5.2D</b> 	<b>T36-I Shape-I</b> 	<b>T36-ILS Shape-ILS</b> 
B5233 Nozzle assembly A	B5237 Nozzle assembly E	B5237 Nozzle assembly E	B5233 Nozzle assembly A	B5235 Nozzle assembly C
<b>T36-J02 Shape-0.2J</b> 	<b>T36-JS02 Shape-0.2JS</b> 	<b>T36-K Shape-K</b> 		
B5234 Nozzle assembly B	B5233 Nozzle assembly A	B5237 Nozzle assembly E		

**Optional Tips and Nozzle Assemblies for FX-8003**

Tip and nozzle assembly are supplied separately. Please purchase a compatible nozzle assembly for your tip referring the chart below.

Unit: mm

**Regular type**

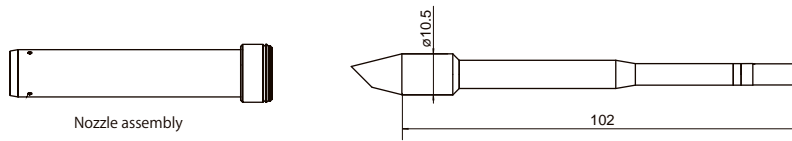

<b>T33-BC2 Shape-2BC</b>	<b>T33-BC3 Shape-3BC</b>	<b>T33-BC4 Shape-4BC</b>	<b>T33-BC5 Shape-5BC</b>	<b>T33-BC6 Shape-6BC</b>
B5070 Nozzle assembly B	B5070 Nozzle assembly B	B5069 Nozzle assembly A	B5069 Nozzle assembly A	B5069 Nozzle assembly A
<b>T33-D24 Shape-2.4D</b>	<b>T33-D32 Shape-3.2D</b>	<b>T33-D5 Shape-5D</b>	<b>T33-D6 Shape-6D</b>	<b>T33-1610</b>
B5070 Nozzle assembly B	B5069 Nozzle assembly A	B5069 Nozzle assembly A	B5069 Nozzle assembly A	B5070 Nozzle assembly B
<b>T33-1611</b>				
B5070 Nozzle assembly B				

**Slim type**

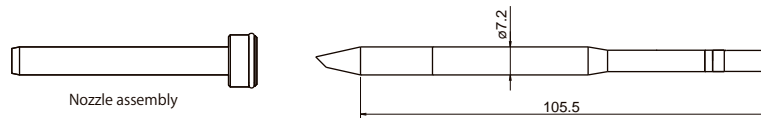

<b>T33-SSBC2 Shape-2SSBC</b>	<b>T33-SSBC3 Shape-3SSBC</b>	<b>T33-SSBC4 Shape-4SSBC</b>	<b>T33-SSBC5 Shape-5SSBC</b>	<b>T33-SSD16 Shape-1.6SSD</b>
B5239 Nozzle assembly C	B5239 Nozzle assembly C	B5240 Nozzle assembly D	B5240 Nozzle assembly D	B5239 Nozzle assembly C
<b>T33-SSD24 Shape-2.4SSD</b>	<b>T33-SSD32 Shape-3.2SSD</b>	<b>T33-SSD6 Shape-6SSD</b>	<b>T33-SS1610</b>	<b>T33-SS1611</b>
B5240 Nozzle assembly D	B5241 Nozzle assembly E	B5241 Nozzle assembly E	B5239 Nozzle assembly C	B5239 Nozzle assembly C

## Optional Tips and Nozzle Assemblies for FX-8302

Tip and nozzle assembly are supplied separately. Please purchase a compatible nozzle assembly for your tip referring the chart below.

Unit: mm

<b>T20-B2 Shape-0.5B</b> 	<b>T20-BL Shape-BL</b> 	<b>T20-BL2 Shape-2BL</b> 	<b>T20-J02 Shape-0.2J (0.2RSB)</b> 	<b>T20-KU Shape-KU</b> 	<b>T20-BL3 Shape-3BL</b> 
B3121 Nozzle assembly A	B3121 Nozzle assembly A	B3121 Nozzle assembly A	B3122 Nozzle assembly B	B3122 Nozzle assembly B	B3123 Nozzle assembly C
<b>T20-D16 Shape-1.6D</b> 	<b>T20-K Shape-K</b> 	<b>T20-BC2 Shape-2BC T20-BCF2*</b> 	<b>T20-BC3 Shape-3BC T20-BCF3*</b> 	<b>T20-BC4 Shape-4BC T20-BCF4*</b> 	<b>T20-C5 Shape-5C</b> 
B3123 Nozzle assembly C	B3123 Nozzle assembly C	B3124 Nozzle assembly D	B3124 Nozzle assembly D	B3124 Nozzle assembly D	B3124 Nozzle assembly D
<b>T20-C6 Shape-6C</b> 	<b>T20-D24 Shape-2.4D</b> 	<b>T20-D32 Shape-3.2D</b> 	<b>T20-BCM2 Shape-2BC with indent</b> 	<b>T20-BCM3 Shape-3BC with indent</b> 	<b>T20-D6 Shape-6D</b> 
B3124 Nozzle assembly D	B3124 Nozzle assembly D	B3124 Nozzle assembly D	B3124 Nozzle assembly D	B3124 Nozzle assembly D	B3561 Nozzle assembly E
<b>T20-1610</b> 		<b>T20-1611</b> 			
B3124 Nozzle assembly D		B3124 Nozzle assembly D		* These tips are tinned on the soldering surface only.	

## Optional Tips and Nozzle Assemblies for FM-2031

Tip and nozzle assembly are supplied separately. Please purchase a compatible nozzle assembly for your tip referring the chart below.

Unit: mm

<b>T22-BL Shape-BL</b> 	<b>T22-BL2 Shape-2BL</b> 	<b>T22-BC2 Shape-2BC</b> 	<b>T22-C3 Shape-3C</b> 	<b>T22-C5 Shape-5C</b> 	<b>T22-C6 Shape-6C</b> 
B3121 Nozzle assembly A	B3121 Nozzle assembly A	B3121 Nozzle assembly A	B3121 Nozzle assembly A	B3124 Nozzle assembly D	B3124 Nozzle assembly D
<b>T22-D08 Shape-0.8D</b> 	<b>T22-D12 Shape-1.2D</b> 	<b>T22-D16 Shape-1.6D</b> 	<b>T22-D24 Shape-2.4D</b> 	<b>T22-D32 Shape-3.2D</b> 	<b>T22-D45 Shape-4.5D</b> 
B3123 Nozzle assembly C	B3121 Nozzle assembly A	B3123 Nozzle assembly C	B3561 Nozzle assembly E	B3124 Nozzle assembly D	B3124 Nozzle assembly D
<b>T22-D52 Shape-5.2D</b> 	<b>T22-J02 Shape-0.2J</b> 	<b>T22-JD08 Shape-0.8JD</b> 	<b>T22-K Shape-K</b> 		
B3124 Nozzle assembly D	B3121 Nozzle assembly A	B3561 Nozzle assembly E	B3123 Nozzle assembly C		

### Optional Tips and Nozzle Assemblies for FM-2032

Tip and nozzle assembly are supplied separately. Please purchase a compatible nozzle assembly for your tip referring the chart below.

Unit: mm

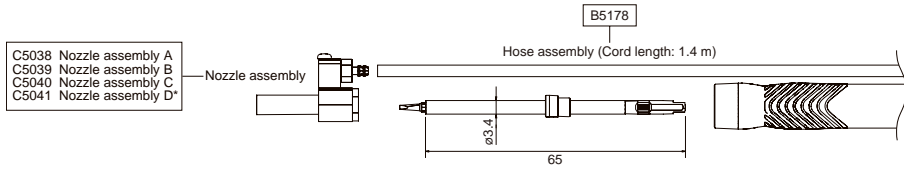

T30-D1 Shape-1D	T30-D06 Shape-0.6D	T30-I Shape-I	T30-J Shape-J	T30-KU Shape-KU	T30-KN Shape-KN
C5038 Nozzle assembly A C5041 Nozzle assembly D*	C5038 Nozzle assembly A C5041 Nozzle assembly D*	C5038 Nozzle assembly A C5041 Nozzle assembly D*	C5040 Nozzle assembly C C5041 Nozzle assembly D*	C5038 Nozzle assembly A C5041 Nozzle assembly D*	C5039 Nozzle assembly B C5041 Nozzle assembly D*

\* Shorter nozzle design provides better visibility.  
For further information, visit our website.

### Optional Tips and Nozzle Assemblies for FM-2026

Tip and nozzle assembly are supplied separately. Please purchase a compatible nozzle assembly for your tip referring the chart below.

Unit: mm

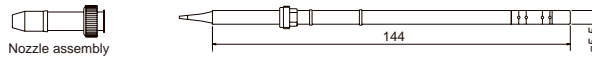

T17-B2 Shape-0.5B	T17-BL Shape-BL	T17-BC1 Shape-1BC T17-BCF1*	T17-BC2 Shape-2BC T17-BCF2*	T17-BC3 Shape-3BC T17-BCF3*	T17-D08 Shape-0.8D
B2708 Nozzle assembly C	B2898 Nozzle assembly E	B2899 Nozzle assembly F	B2706 Nozzle assembly A	B2900 Nozzle assembly G	B2709 Nozzle assembly D
T17-D16 Shape-1.6D	T17-D24 Shape-2.4D	T17-J02 Shape-0.2J	T17-KF Shape-KF	T17-KR Shape-KR	T17-KU Shape-KU
B2708 Nozzle assembly C	B2708 Nozzle assembly C	B2707 Nozzle assembly B	B2923 Nozzle assembly J	B2902 Nozzle assembly I	B2901 Nozzle assembly H
T17-BCM2 Shape-2BC with indent	T17-BCM3 Shape-3BC with indent				
B2706 Nozzle assembly A	B2900 Nozzle assembly G	* These tips are tinned on the soldering surface only.			

### Replacement Tips and Nozzle Assemblies for FX-8802

Tip and nozzle assembly are supplied separately. Please purchase a compatible nozzle assembly for your tip referring the chart below.

Unit: mm

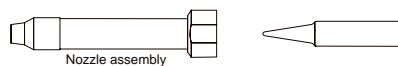

T18-B Shape-B	T18-C05 Shape-0.5C	T18-C1 Shape-1C T18-CF1*	T18-C2 Shape-2C T18-CF2*	T18-C3 Shape-3C T18-CF3*	T18-D08 Shape-0.8D
B3662 Nozzle assembly A	B3664 Nozzle assembly C	B3664 Nozzle assembly C	B3662 Nozzle assembly A	B3663 Nozzle assembly B	B3662 Nozzle assembly A
T18-D12 Shape-1.2D	T18-D16 Shape-1.6D	T18-D24 Shape-2.4D	T18-K Shape-K	T18-I Shape-I	
B3662 Nozzle assembly A	B3663 Nozzle assembly B	B3663 Nozzle assembly B	B3665 Nozzle assembly D	B3664 Nozzle assembly C	* These tips are tinned on the soldering surface only.

## DASH

### Ceramic Heater Soldering Iron

Tip included



- An entry model of ceramic heater soldering iron
- Ideal for electronic circuit assembly



#### Packing List

FX-650	Unit
--------	------

#### Features

Slim handle improves your work efficiency!

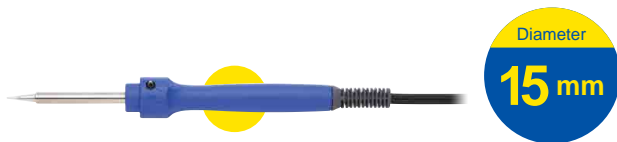

Simple and easy tip replacement



Quick change just loosening a screw

#### Specifications

Model No.	FX-650
Power consumption	16 W
Heating element	Ceramic heater
Standard tip	Shape-B (No.T34-B)
Total length*	224 mm
Weight*	60 g (with B tip)

\* Without cord

#### Option

Part No.	Name	Specifications
FH300-81	Iron holder	With cleaning sponge
633-01	Iron holder	With 599B
633-02	Iron holder	With cleaning sponge
605M	Iron cover	-



#### Replacement Tips for DASH

Unit: mm

<b>T34-B Shape-B</b> 	<b>T34-C08 Shape-0.8C</b> 	<b>T34-C2 Shape-2C</b> 	<b>T34-C3 Shape-3C</b> 	<b>T34-C4 Shape-4C</b> 
<b>T34-D32 Shape-3.2D</b> 	<b>T34-I Shape-I</b> 			

# FX-901

## Battery-Powered Soldering Iron

Tip included



- Easy-to-carry soldering iron powered by AA alkaline batteries
- Cordless design makes this iron very handy and usable virtually anywhere.

### Easy Replacement

#### Easy tip replacement

Turn the nipple  
90° clockwise.



#### Easy battery replacement



### Packing List

FX-901	Unit, Cap
--------	-----------

\* Batteries not included

### Specifications

Model No.	FX-901
Power supply	AA x 4 pcs
Power consumption	Alkaline batteries: 6 W (6 V) Nickel hydrogen batteries (2150 mAh): 5 W (4.8 V)
Standard tip	Shape-B (No.T11-B)
Battery life*	Alkaline batteries: 60 minutes Nickel hydrogen batteries (2150 mAh): 120 minutes
Total length**	212 mm
Weight***	76 g

Measurement conditions

- When using new batteries, performance will vary depending on the batteries.
- The operating time was measured from the point that the soldering iron was turned on to the point at which the temperature dropped below 300°C, which is the minimum temperature at which soldering can be performed.

\* When using batteries other than those specified above, the performance and the operating time will vary.

\*\* Without cap

\*\*\* Without battery

### Replacement Tips for FX-901

Unit: mm

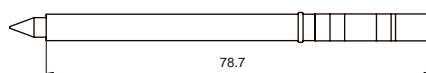

T11-B Shape-B

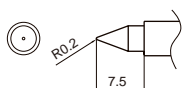

T11-D4 Shape-4D

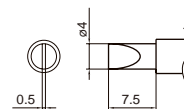

## FS-210

### Brush-tip Type Flux Pen



- Pen tip does not split easily.
- You can fill your favorite flux into FS-210.
- Simply push the pen shaft when you need some extra flux.

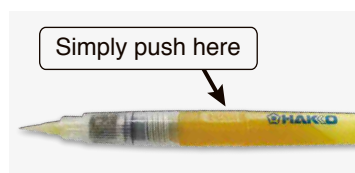

#### Features

Pen for pinpoint application of optimum amount of flux

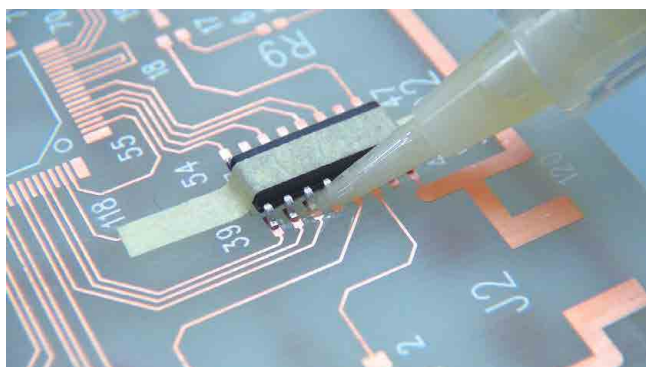

#### Packing List

FS210-82	Flux container for 4 mL (5 pcs)
----------	---------------------------------

\* No Flux contained.

#### Replacement Parts

Part No.	Name	Specifications
A5009	Brush-tip	with a cap (5 pcs)

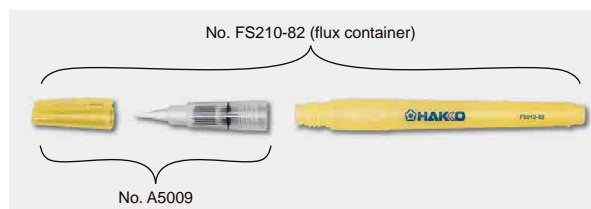

## 611 ESD SAFE

### Reel Stand



No.611-2



- Solder reel stand for coiled solder with a maximum load of 1 kg
- Smooth action when reeling out solder wire improves work efficiency
- A mounting screw for the grounding wire is attached on the baseplate.

#### Specifications

Part No.	611-1	611-2
Shaft diameter	ø15 mm	
Usable solder	Roll solder 1 kg (max.) × 1	Roll solder 1 kg (max.) × 2
Dimensions	87 (W) × 78 (H) × 141 (D) mm	87 (W) × 200 (H) × 141 (D) mm
Weight	450 g	750 g



## 375

### V-Groove Maker



- Cutting a V-groove put on the solder surface reduces the splash of solder and flux.
- The solder feed amount can be controlled by turning the switch on and off.
- Compact, space-saving automatic solder feeder

### Features

#### Minimize solder and flux splash

Cutting a V-groove on the solder surface enables the release of gas pressure generated by the flux, thereby suppressing splash. HAKKO 375 can cut a groove in only the solder needed, then helps to reduce the level of defectiveness.

#### Advantages of V-grooved solder

-Examination of solder and flux splash

#### Test criteria

Measurement method	Measure the amount of solder and flux splashing after solder is fed to the soldering iron
Temperature setting for soldering iron	350°C and 400°C
Solder	Lead-free (Sn-3Ag-0.5Cu) Halogen-free flux ø0.3 mm and ø1 mm
Solder feed length	50 mm

\* The effect of solder and flux splashing prevention may differ under different operation conditions.

Solder cross-section view

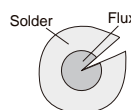

3D view

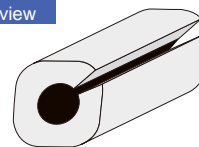

V-grooved solder

#### Amount of flux splashing (quantity of dots)

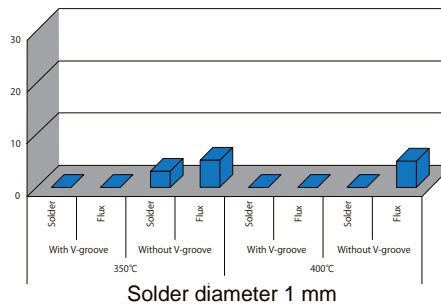
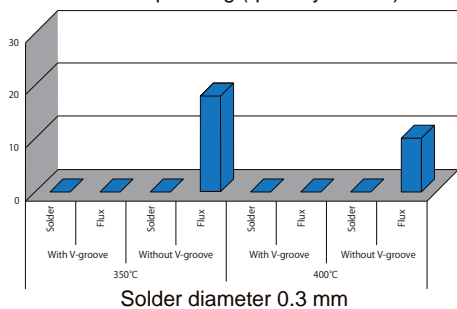

### Packing List

375	Unit, AC Adapter, Instruction manual
-----	--------------------------------------

### Option

Part No.	Name
B1649	Foot switch
B2763	Hand switch

### Specifications

Model No.	375
Rating	24 VDC 75 mA
Solder feed speed	27 mm/sec.
Usable solder diameter	ø0.3, 0.5, 0.6, 0.8, 1 mm
Dimensions	78 (W) × 98 (H) × 56 (D) mm
Weight	0.59 kg

#### AC Adapter

Output voltage	24 VDC
----------------	--------

## 373 ESD SAFE

### Self Feeder



- Automatic solder feeder that enables a user to complete soldering work with just one hand
- The solder feed time and speed can be set.

### Set-Up Example

#### • One handed soldering

Soldering irons + HAKKO 373 + Solder diameter adjustment ring + Tube unit with switch + Guide pipe assembly

\* See the applicable soldering irons in the P.49.

Set-up example

#### • Soldering with a feeder pen

Soldering irons + HAKKO 373 + Solder diameter adjustment ring + Feeder pen + Switch

\* Compatible with all soldering irons

Set-up example

Foot switch or Feeder switch

### Specifications

Model No.	373
Power consumption	6 W
Solder feed time	0 to 7 sec. (auto mode)
Solder feed speed	4.5 to 26 mm/sec.
Solder feed quantity	0 to 182 mm
Solder return quantity	0 to 5 mm (fixed speed)
Mode	Auto and manual
Usable solder diameter*	ø0.6, 0.65, 0.8, 1, 1.2, 1.6 mm
Usable solder quantity	1 kg or less
Dimensions	107 (W) × 110 (H) × 215 (D) mm
Weight**	1.5 kg

\* ø1.6 mm lead free solder can't be used.

\*\* With cord

### Packing List

373	Unit, Instruction manual
-----	--------------------------

The accessories that are required for initial set-up, such as a tube unit, guide pipe assembly, and solder diameter adjustment ring, are not included. They must be ordered separately and adapted to use with the soldering iron and solder wire diameter.

## Features

### The new tube unit and guide pipe assembly for the best productivity

The combination of the new tube unit and the new guide pipe assembly makes it possible to obtain "Heat-Bridge Effect".

The new optional parts are designed to feed solder from the underside of the tip. The one-handed soldering just like manual soldering can be achieved.

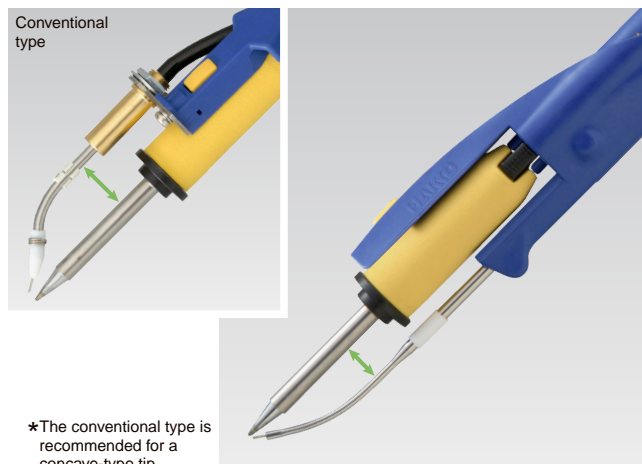

### What is a "Heat-Bridge" ?

It is the phenomenon that the heat from the tip being transferred quickly to soldering joint area via molten solder.

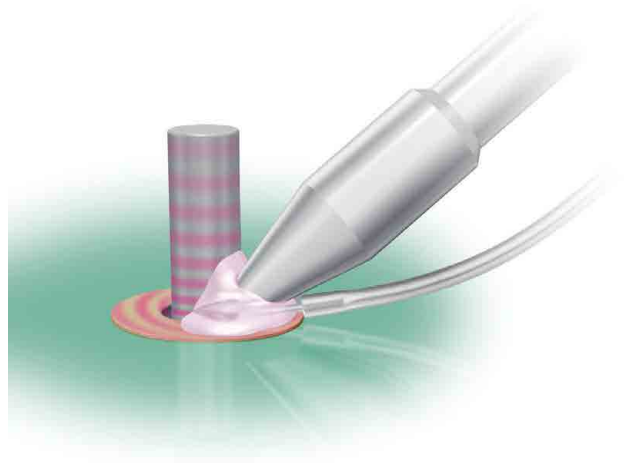

### Easy adjustment of the solder feeding position

The new tube unit makes it easy to adjust the solder feeding position by holding the guide pipe assembly tightly with the two parts.



For farther details, please scan here.

### Tip replacement without removing the tube unit

Tip can be replaced without removing the tube unit. It saves the trouble of adjusting the position of solder feeding.

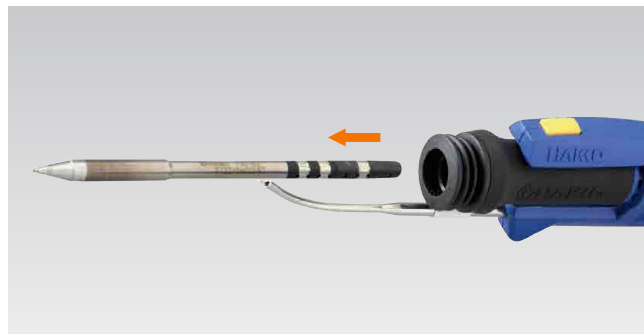

### Easy maintenance

New guide pipe assembly will have less residue of flux fume and clogging with the residue while feeding solder from the underside of the tip.

#### Impact of flux fume: High



#### Impact of flux fume: Low



\*Image for illustration purpose

### Quick and sure tip cleaning with FT-720

The tip cleaner FT-720 cleans a tip quickly and surely even having the guide pipe assembly on a handpiece.









For further information of FT-720, see P. 58 to 60.

















# Solder Feed System

## Accessory Selection Guide

### ■ One-handed operation soldering Bottom-feed type

Station	Applicable soldering iron	Solder feed unit	Solder diameter (Φ) : mm	Solder diameter adjustment ring	Guide pipe assembly	Tube unit	Iron receptacle
FX-951 FX-950/FX-952 FM-203/FM-206 	FM-2028 FM-2027 	373	0.6, 0.65	B1626	B5268	C5056	B5265
			0.8	B1627	B5269		
			1	B1628	B5270		
			1.2	B1629	B5271	C5057	
FX-100 	FX-1001 	373	0.6, 0.65	B1626	B5268	C5056	B5266
			0.8	B1627	B5269		
			1	B1628	B5270		
			1.2	B1629	B5271	C5057	
FN-1010 FX-801 FX-838 FM-203/FM-206 	FN-1101 FX-8002 FX-8301 FM-2030 	373	0.6, 0.65	B1626	B5272	C5058	B5265
			0.8	B1627	B5273		
			1	B1628	B5274		
			1.2	B1629	B5275	C5059	
FX-888D FX-889 	FX-8801 FX-8805 	373	0.6, 0.65	B1626	B5272	C5058	B5267
			0.8	B1627	B5273		
			1	B1628	B5274		
			1.2	B1629	B5275	C5059	

## Conventional type

Station	Applicable soldering iron	Solder feed unit	Solder diameter (Φ) : mm	Solder diameter adjustment ring	Guide pipe assembly	Tube unit
FX-951 FX-950/FX-952 FM-203/FM-206 	FM-2028 FM-2027 	373	0.6, 0.65	B1626	B3481	B3477
			0.8	B1627	B3482	
			1	B1628	B3483	
			1.2	B1629	B3484	
FN-10101 FM-203/FM-206 	FN-1101 FM-2030 	373	0.6, 0.65	B1626	B3726	B3477
			0.8	B1627	B3727	
			1	B1628	B3728	
			1.2	B1629	B3729	
FX-100 	FX-1001  <small>*The spacer No.B5183 is required separately</small>	373	0.6, 0.65	B1626	B3481	B3477
			0.8	B1627	B3482	
			1	B1628	B3483	
			1.2	B1629	B3484	
FX-801 	FX-8002 	373	0.6, 0.65	B1626	B5072	B3477
			0.8	B1627	B5073	
			1	B1628	B5074	
			1.2	B1629	B5075	
FX-838 	FX-8301 	373	0.6, 0.65	B1626	B3566	B3563
			0.8	B1627	B3567	
			1	B1628	B3568	
			1.2	B1629	B3569	
			1.6	B1630	B3570	
FX-888D FX-889 	FX-8801 	373	0.6, 0.65	B1626	B2146	B2143
			0.8	B1627	B2147	
			1	B1628	B2148	
			1.2	B1629	B2149	
			1.6	B1630	B2150	
FX-888D FX-889 	FX-8805 	373	0.6, 0.65	B1626	B2151	B2143
			0.8	B1627	B2152	
			1	B1628	B2153	
			1.2	B1629	B2154	
			1.6	B1630	B2155	

## ■ Feeder pen

Applicable soldering iron	Solder feed unit	Solder diameter	Options		
			Solder diameter adjustment ring	Feeder pen	Switch
Compatible with all soldering irons	373	0.6, 0.65 mm	B1626	C1234	B2124 feeder switch or B1649 foot switch
		0.8 mm	B1627		
		1 mm	B1628		
		1.2 mm	B1629	C1235	
		1.6 mm	B1630		

## FG-100B

### Thermometer with Auto-measurement Function



- Automatic temperature measurement can minimize individual differences in measuring temperature.
- Measurement counter can be useful for control of changing sensor.
- Long life sensor AS5000 (with certificate of conformance) is equipped as standard.

#### Packing List

<b>FG-100B</b>	Unit, 006P 9 V Manganese dry battery (for trial), Sensor, Instruction manual
----------------	--

#### Specifications

Model No.	FG-100B
Power supply	006P 9 V dry battery (alkaline cell recommended)
Temperature resolution	1°C
Temperature measurement range	0 to 700°C
Temperature precision	±3°C (300 to 600°C) ±5°C (other than above)
Temperature sensor*	K (CA) type thermocouple
Display	LCD: 3 1/2 digits
Operating environment	Ambient temperature/Humidity range: 0 to 40°C, max.80% RH (without condensation)
Environmental conditions	Applicable rated pollution degree 2 (according to IEC/UL 61010-1)
Dimensions**	68 (W) × 140 (H) × 38 (D) mm
Weight***	125 g

\* The temperature sensor can only be used to measure temperatures below 500°C. To measure higher temperatures, use an applicable temperature probe.

\*\* Excluding protrusions

\*\*\* Without battery

## Features

**Minimize individual differences in how to complete measurement and read result.**

\* Image photo below  
 AUTO HOLD function and MAX HOLD function cannot be used at the same time.



### 1. AUTO HOLD Function

The measurement will end automatically when tip temperature is stabilized.

The measurement process will be the same no matter who does it.

### 2. MAX HOLD Function

Max measured tip temperature will be displayed.

This function can be useful for quality control of components and P.W.B.

### 3. Temperature Measurement Count Function

Number of tip temperature measurement will be automatically counted.

This function can be useful for control of changing sensor.

### Temperature Sending Function

Measurement result by AUTO HOLD function or MAX HOLD function can be sent to a soldering station (FN-1010 : refer to P.10) through infrared.

This function can eliminate manual process of recording results, the time for the process, and human error.

## Option / Replacements

Part No.	Name	Specifications
A1310	Temperature probe	For solder bath and pot
C1541	Temperature probe	For hot air station
A1556	Sensor A	-
A1557	Sensor B	-
AS5000	Sensor	lead-free with cert conformance

**Long life sensor AS5000 (for FG-100B, FG-101B and FG-102) is equipped as standard.**

Lasts 30 times longer than a conventional sensor\*. Save troubles of sensor replacements and enhance stable measurement for a long time. Certificate of conformance is included.

\* Based on our in-house test



## FG-102

### Soldering Iron Thermometer with Traceability Management System



- Free of errors in temperature measurement
- Free of transcription errors for measured temperature
- Standardization of temperature measurement
- Secure management of tip temperature records
- Long life sensor AS5000 (with certificate of conformance) is equipped as standard.

#### Packing List

<b>FG-102</b>	Unit, Battery (6 pcs, for trial), Barcode reader, USB cable, Software (CD-ROM), Sensor, Barcode sticker for soldering iron ID (30 pcs), Barcode sticker for operator ID (30 pcs), Instruction manual
---------------	--

#### Option / Replacements

Part No.	Name	Specifications
A1310	Temperature probe	for soldering bath and pot
C1541	Temperature probe	for hot air station
A1556	Sensor A	–
A1557	Sensor B	–
C5009	Bar code reader	–
AS5000	Sensor	lead-free with cert conformance

#### Specifications

Model No.	FG-102
Power supply	AA sized (LR6) battery x 6 (alkaline cell recommended)
Temperature resolution	1°C
Temperature measurement range	0 to 700°C
Temperature precision	±3°C (300 to 600°C) ±5°C (other than above)
Temperature sensor*	K (CA) type thermocouple
Display	LCD
Operating environment	Ambient temperature/Humidity range: 0 to 40°C, max.80% RH (without condensation)
Environmental conditions	Applicable rated pollution degree 2 (according to IEC/UL 61010-1)
Dimensions**	193 (W) x 90 (H) x 219 (D) mm
Weight***	0.93 kg

\* Temperature sensor can only be used if measure temperatures below 500°C.  
To measure higher temperatures, use an applicable temperature probe.

\*\* Without barcode reader

\*\*\* Without battery and barcode reader

\*\*\*\* Traceability management function can only be used for soldering irons.



## Features

### An Innovation in Tip Temperature Control

#### Flow chart of management

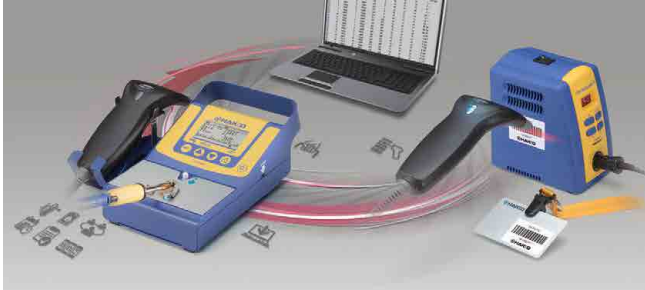

1. Scan the unit and the measurer's ID by a barcode reader.
2. Measure the temperature.
3. Press the REC button to save the data on the unit main body.
4. Transfer and save the data on the PC.

#### Free of errors in temperature measurement by standardization of temperature measurement

The unit has a function to notify the end of measurement. When measurement is finished, "H" icon stops blinking. The unit can find measurement errors and prompt an operator to repeat measurement. The display shows "Fail" if tip loses appropriate contact with sensor before completion of measurement.

#### Pass/Fail judgment on measured temperature

Pass/Fail judgment on measured temperature can be automatically made if an acceptable temperature range is registered in advance (the display shows "OK" or "Fail").

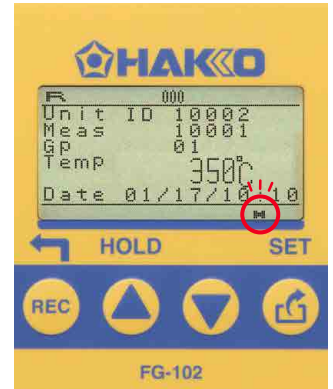
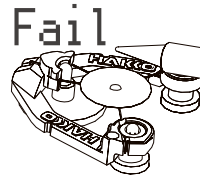
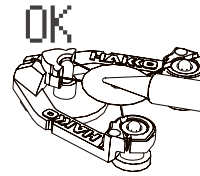

#### Make it easy to manage tip temperature records by transferring the data to computer



No	InstID	Gr No	MeasID	Temp	Set Temp	Month	day	hour	min	OK/NG	
1	10023	0	10005	375	380	10	10	21	14	47	---
2	10024	0	10005	372	380	10	10	22	14	48	---
3	10025	0	10005	372	380	10	10	23	14	49	---
4	10026	0	10005	373	380	10	10	24	14	50	---
5	10027	0	10005	375	380	10	10	25	14	51	---
6	10028	0	10005	375	380	10	10	26	14	52	---
7	10029	0	10005	373	380	10	10	27	14	53	---
8	10030	0	10005	376	380	10	10	28	14	54	---
9	10001	1	10005	371	380	10	10	29	14	55	OK
10	10002	1	10005	371	380	10	10	30	14	55	OK
11	10003	1	10005	372	380	10	10	31	14	56	OK
12	10004	1	10005	382	380	10	10	32	14	57	OK
13	10005	5	10005	382	380	10	10	33	15	3	NG
14	10006	5	10005	380	380	10	10	34	15	4	NG

Free of transcription errors for measured temperature

## More Features



#### Group control

Groups can be created based on different set temperatures for different operations. Pass/Fail judgment on measured temperatures can be automatically made for different acceptable temperature ranges.



Automatic counting of the number of measurements



Notification of the calibration date

## FG-101B New

### Soldering Iron Tester with Auto-measurement Function



- Soldering iron tester for measurement of tip temperature, leak voltage, and tip to ground resistance
- Human error-free operation
- Long life sensor AS5000 (with certificate of conformance) is equipped as standard.

#### Packing List

<b>FG-101B</b>	Unit, Conduction wire, Ground clip, Multi-adapter*, European adapter*, Fuse, Power cord, Sensor, Instruction manual
----------------	---

\*May not be included depending on the specifications

#### Option / Replacements

Part No.	Name	Specifications
A1310	Temperature probe	For solder bath and pot
C1541	Temperature probe	For hot air station
A1556	Sensor A	—
A1557	Sensor B	—
C5055	Adapter module	—
AS5000	Sensor	lead-free with cert conformance

#### Specifications

Model No.	FG-101B
Power consumption	3.6 W
Temperature resolution	1°C
Temperature measurement range	0 to 700°C
Temperature precision	±3°C (300 to 600°C) ±5°C (other than above)
Temperature sensor*	K (CA) type thermocouple
Voltage resolution	0.1 mV
Voltage measurement range	0 to 40 mV (AC)
Voltage precision	± (5% of reading + 1 digit)
Resistance resolution	0.1 Ω
Resistance measurement range	0 to 40 Ω
Resistance precision	± (5% of reading + 1 digit)
Display	LCD : 3 1/2 digits
Operating environment	Ambient temperature/Humidity range: 0 to 40°C, max.80% RH (without condensation)
Environmental conditions	Applicable rated pollution degree 2 (According to IEC/UL61010-1)
Dimensions	211(W) × 53(H) × 126(D) mm
Weight	0.95 kg

\* The Temperature sensors can only be used to measure temperatures below 500°C. To measure higher temperatures, use an appropriate temperature probe.

## Features

**For the daily maintenance of soldering station**  
Control of "tip temperature", "leak voltage", and "tip to ground resistance" is required for a grounded soldering station for electronic components.



### What is leak voltage and tip-to-ground resistance?

#### Leak voltage

Leak current is the current that leaks from the tip to a board or device. Leak voltage is a specific measurement of the level of this current. The leakage can adversely affect delicate devices, so it is necessary to check leak voltage on a daily basis.



#### Tip-to-ground resistance

Most leak current flows from the tip via the ground wire to the outlet ground terminal, and is prevented from affecting the device. Because of this, tip-to-ground resistance is another important issue that must be checked daily.

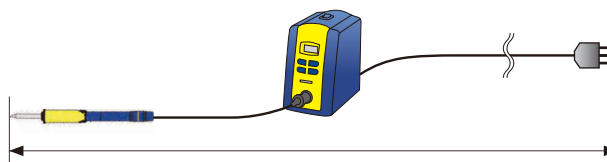

### Human error-free operation



#### 1. AUTO HOLD function

The measurement will end automatically when the displayed tip temperature is stabilized. Individual differences in temperature measurement can be minimized.

#### 2. Data send function (infrared)

Measurement result can be sent to IoT capable soldering station, such as FN-1010, and be recorded automatically. Human errors in manual recording can be eliminated.

## Option

### Adapter module

By connecting FG-101B and IoT capable soldering station, such as FN-1010, with adapter module, data transfer can be easy and smooth.

For more details, please visit website.



## FT-720 ESD SAFE **New**

Tip Cleaner



- Reduce time for tip cleaning and increase efficiency in soldering process.



## FT-710 ESD SAFE

Solder-Splash-Preventing Rotary Tip Cleaner



- Prevents solder from splashing when cleaning.



### Features of FT-720

#### Quick tip cleaning

Increasing efficiency in soldering process by reducing time for tip cleaning.

#### Comparison of cleaning time

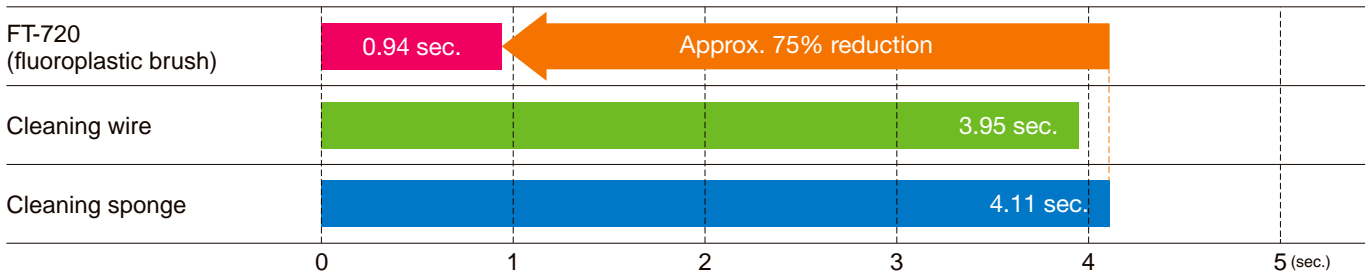

\* The above values are measured values and not guaranteed values.

#### Cleaning a variety of tip shapes

FT-720 surely and quickly cleans a variety of tip shapes, and also a tip even having the guide pipe assembly on a handpiece.

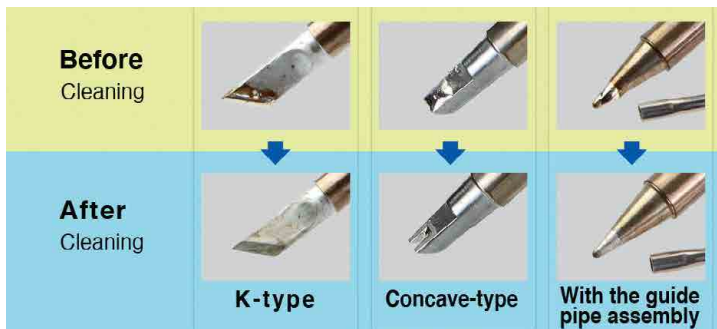

#### The compact design

It is also designed to be installed on the iron holder, FH-200, to make efficient use of the workspace.



### Features of FT-710

#### Solder-Splash prevention



#### Please choose the receptacle to tip type

##### Compatibility table

Tip	Receptacle A	Receptacle B	Receptacle C
T15, T11, T36	✓		
T18		✓	
T20, T17, T22			✓

\* This cleaner cannot be used with T15-JL02, quad type, tunnel type, and spatula type soldering tips of T15 series.

\* It can be used with T19 series, only with the use of a custom-ordered receptacle. In this situation, consult your nearest HAKKO dealer or distributor.

\* It cannot be used with FX-8802 and FX-8803 with T18 series.

\* There are some tips with dimensions that cannot be adjusted with the standard receptacles. In this situation, consult your nearest HAKKO dealer or distributor.

# Tip Cleaner

## Features of FT-710 and FT-720

### Minimizing tip temperature drop

Tip cleaner can help increase productivity by shortening the cleaning time and minimizing the tip temperature drop with no use of water.

\* The following graph is for FT-720. For FT-710, please visit our website.

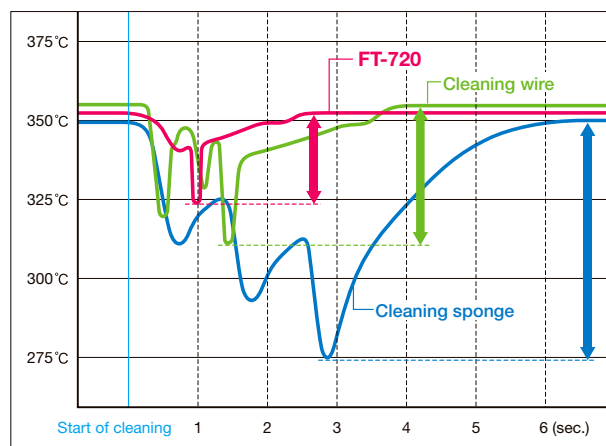

\* The above values are measured values and not guaranteed values.

### Brush lineup for different purposes

#### Fluoroplastic brush



**Long-life brush with excellent durability**  
Effective in reducing of solder balls while tip cleaning.

#### Resin brush



**Effective in reducing the impact of tip oxidation**  
Recommended for soldering with lead-free alloy or halogen-free flux.

#### Metal brush



**Effective in removing solder from a tip completely**  
Recommended for soldering fine and precise components.

### Easy maintenance

Solder waste can be easily removed just by taking off the cover. No tool is required to remove the brushes.

#### Removal of solder waste



\* The safety design requires removal of the AC adapter to take off the cover.

#### Replacement of the cleaning brushes



### Packing List

FT-720	Unit (with adjuster), AC adapter, Instruction manual
FT-710	Unit, AC adapter, Receptacle A, Receptacle B, Lock nut, Gauge, Instruction manual

### Specifications

Model No.	FT-720	FT-710
Rating	24 VDC 140 mA	24 VDC 130 mA
Brush rotational speed	1670 rpm	2500 rpm
Standard receptacle	—	Receptacle A and B
Dimensions	67(W) × 63(H) × 94(D) mm	71 (W) × 77 (H) × 107 (D) mm
Weight	200 g	450 g

#### AC adapter

Output voltage	24 VDC	24 VDC
----------------	--------	--------

### Optional for FT-720

Part No.	Name	Specifications
A1566	Cleaning brush A	Plastic brush, qty 2
A1567	Cleaning brush B	Metal brush, qty 2
A5062	Sensor cover	qty 10
A5061	Adjuster	—

### Optional for FT-710

Part No.	Name	Specifications
A1567	Cleaning brush B	Metal brushes, qty 2
B3519	Receptacle C	—

## FT-700

### Tip Polisher



- Soldering tip polisher best suited to the removal of carbide and oxide on soldering tips
- Prevents the shortening of the service life of tips caused by oxidation

### Usage

#### Cleaning procedure

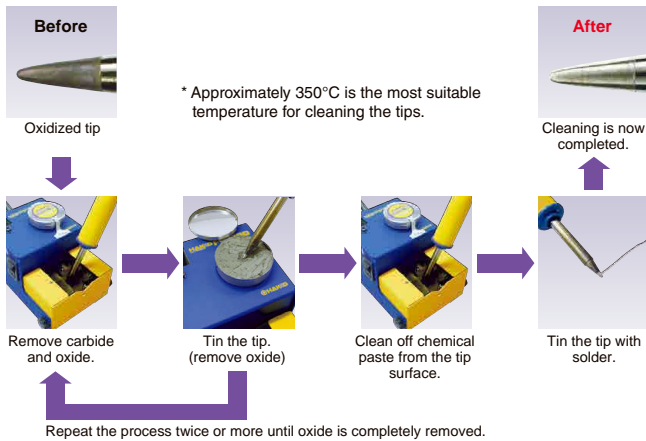

Use the brush to remove tough oxide.

## FS-100

### Chemical Paste



- Chemical paste best suited to the removal of oxide on soldering iron tips
- Also used for retinning of soldering tips

### Packing List

FS-100	Paste, Instruction manual
--------	---------------------------

### Specifications

Chemical paste	
Amount	10 g
Ingredients	Flux, tin (Sn) 50 wt% (each)

\* The flux component of chemical paste consists of alicyclic amine hydrobromate, aliphatic amine hydrobromate, petrolatum, and wax.

\* Make sure the tip is cleaned after use according to the procedure shown above.

\* Do not use the chemical paste for purpose other than restoring of the soldering tip.

## FA-430 ESD SAFE

### Air-Purifying Fume Extractor



- HEPA filter (High Efficiency Particulate Air Filter)
- Filters out 99.97% of particles greater than 0.3  $\mu\text{m}$
- Recommended for quiet laboratory and office

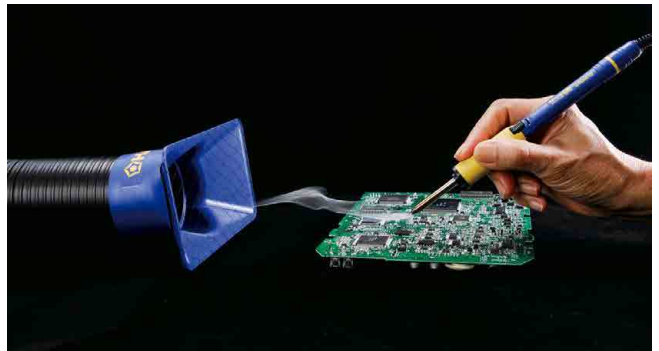

#### Features of FA-430

Filter efficiency is 99.97% of particles greater than 0.3  $\mu\text{m}$  (HEPA filter).

Aerosol particle diameter range

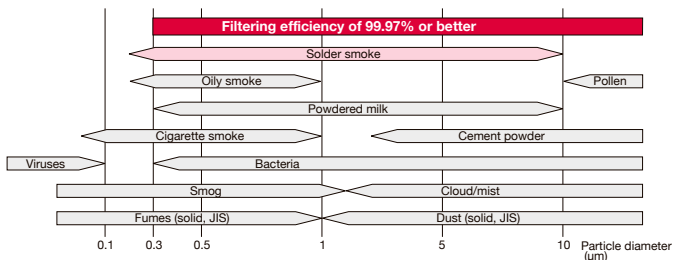

**NOTE:** Filter efficiency is an initial value of collection efficiency based on counting method for airborne dust collected by a single plate of filter (unfolded).

#### Filter replacement notification function

##### Pre-filter

When the pre-filter is 80% clogged or has been used for 200 hours, the orange indicator flashes on and off.

##### HEPA main filter

When the 10th pre-filter needs replacing, the orange and red lamps flash on and off.

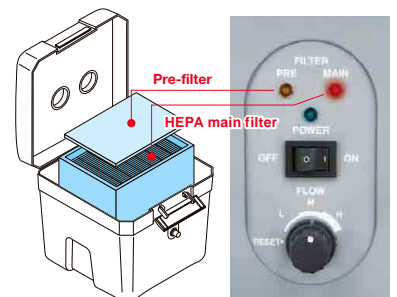

#### Packing List

<b>FA-430</b>	Main unit, Power cord, Cap, Main filter, Pre-filter (qty 10), Instruction manual
---------------	--

\* Ducts are optional parts.

#### Specifications

Model No.		FA-430
Power consumption		110 W
Noise level*		50 dB (A) (MEDIUM mode)
Suction capacity**	HIGH	4.7 m <sup>3</sup> /min.
	MEDIUM	3.7 m <sup>3</sup> /min.
	LOW	2.8 m <sup>3</sup> /min.
Filtering efficiency	HIGH	99.96% (0.3 $\mu\text{m}$ )***
	MEDIUM	99.97% (0.3 $\mu\text{m}$ )***
	LOW	99.97% (0.3 $\mu\text{m}$ )***
Static pressure		1500 Pa
Duct set (sold separately)****		$\varnothing$ 55 mm x 1.2 m (ESD SAFE)
Dimensions		330 (W) x 366 (H) x 343 (D) mm
Weight		7.5 kg

\* Measured at a distance of 1 meter from the face of the unit in an anechoic chamber.

\*\* When using two ducts

\*\*\* It is an initial value of collection efficiency based on counting method for airborne dust collected by a single plate of filter (unfolded).

\*\*\*\* Nets in duct sets are not protected against electrostatic discharge.



# FA-431 ESD SAFE

## Air-Purifying Fume Extractor



- Excellent cost performance filter
- Filters out 97% of particles greater than 0.3 μm
- Optional sub-filters extend the life of Pre and Main filters
- Ideal for factories with a lot of soldering work

### Features of FA-431

The life of pre-filter and main filter will be approximately 4 times\* longer.

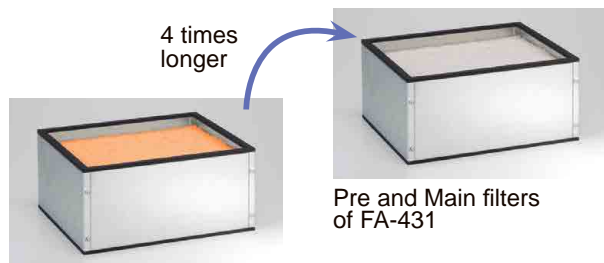

Pre and Main filters of FA-430

With the use of sub-filter, it will be approximately 10 times\* longer.

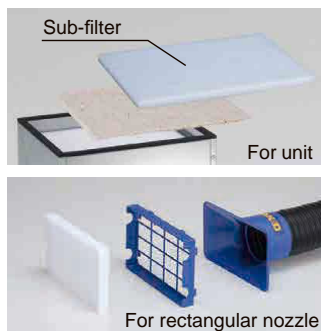

Remote control equipped Very easy to switch ON/OFF



\* The filter life will be differ depending on the work environments and work conditions.

### Packing List

<b>FA-431</b>	Main unit, Power cord, Remote control, Cap, Main filter, Pre-filter (qty 10), Instruction manual
---------------	--

\* Ducts are optional parts.

### Specifications

<b>Model No.</b>		FA-431
<b>Power consumption</b>		110 W
<b>Noise level*</b>		50 dB (A) (MEDIUM mode)
<b>Suction capacity**</b>	HIGH	4.7 m <sup>3</sup> /min.
	MEDIUM	3.7 m <sup>3</sup> /min.
	LOW	2.8 m <sup>3</sup> /min.
<b>Filtering efficiency</b>	HIGH	97% (≥0.3 μm)
	MEDIUM	
	LOW	
<b>Static pressure</b>		1500 Pa
<b>Duct set (sold separately)***</b>		ø55 mm x 1.2 m (ESD SAFE)
<b>Dimensions</b>		330 (W) x 366 (H) x 343 (D) mm
<b>Weight</b>		7.2 kg

\* Measured at a distance of 1 meter from the face of the unit in an anechoic chamber.  
 \*\* When using two ducts  
 \*\*\* Nets in duct sets are not protected against electrostatic discharge.

# Air-Purifying Type

## Common Features of FA-430 and FA-431

### Quiet operation and powerful suction

	FA-430/431		Previous model (HAKKO 421)	
	Noise level dB (A)	Air volume m <sup>3</sup> /min.	Noise level dB (A)	Air volume m <sup>3</sup> /min.
HIGH	53	4.7	60*	3.2*
MEDIUM	50	3.7		
LOW	44	2.8		

\*Values measured when the unit was used with a 60 Hz power supply.

### Flexible ducts and compact body for perfect placement



### Movement of smoke is affected by the surrounding environment

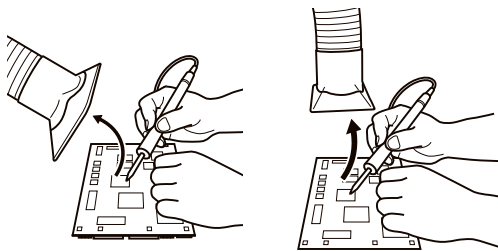

If the duct is mounted at an angle above the workpiece, it is affected by air conditioning.

If the duct is mounted directly above, it can be difficult to see the workpiece.

### Recommended angle

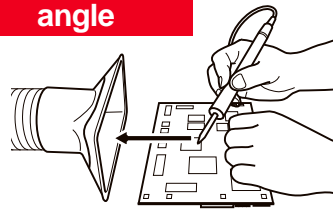

Duct is mounted on the worktable to provide excellent suction performance.

### Freestanding ducts



Perfect placement provides suction where you need it.

### Option

Part No.	Name	Specifications
C1571	Duct Set	With rectangular nozzle
C1572	Duct Set	With round nozzle
A5035	Sub-filter	For FA-431, set of 5
A5036	Sub-filter for rectangular nozzle	For FA-431, set of 20
A5037	Sub-filter for round nozzle	For FA-431, set of 20
B5146	Filter case for rectangular nozzle	For FA-431
B5147	Filter case for round nozzle	For FA-431



No.C1571



No.C1572

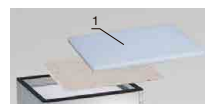

1: No.A5035

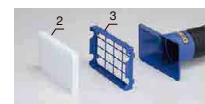

2: No.A5036  
3: No.B5146



4: No.A5037  
5: No.B5147

## FA-400 ESD SAFE

### Desktop Type Smoke Absorber



- Desktop solder smoke absorber that can be mounted horizontally or vertically
- An optional arm stand makes a third mounting position available.

#### 2 Way Plus Placement

Vertically mounted:



Horizontally mounted:



Using a stand (option):



#### Packing List

FA-400	Unit, Filter, Instruction manual
--------	----------------------------------

#### Specifications

Model No.	FA-400
Power consumption	50 Hz: 22 W 60 Hz: 18 W
Noise level*	50 Hz: 48 dB 60 Hz: 51 dB
Suction capacity**	Vertically: 1 m <sup>3</sup> /min. (50 Hz), 1.1 m <sup>3</sup> /min. (60 Hz) (max.) Horizontally: 0.4 m <sup>3</sup> /min. (50 Hz), 0.5 m <sup>3</sup> /min. (60 Hz) (max.)
Air velocity	Vertically: 1 m/sec. (50 Hz), 1.1 m/sec. (60 Hz) Horizontally: 2.6 m/sec. (50 Hz), 2.9 m/sec. (60 Hz)
Filter size	130 (W) × 130 (H) × 10 (D) mm
Dimensions	166 (W) × 212 (H) × 113 (D) mm
Weight***	0.91 kg

\* Measured at a distance of 1 m from the face of the unit

\*\* Measured with a filter present

\*\*\* Without cord

#### Option

Part No.	Name	Specifications
C1568	Arm stand	With knobs

## FX-301B ESD SAFE

High Performance Soldering Pot

Digital



- Digital display ensures reliable temperature control and realizes precise temperature adjustment.
- Soldering pot is coated in a special long-life material, which is best suited for lead-free solder. This is provided as a standard feature.
- Time comparison to reach set temperature

FX-301B vs. HAKKO 96 (conventional model)

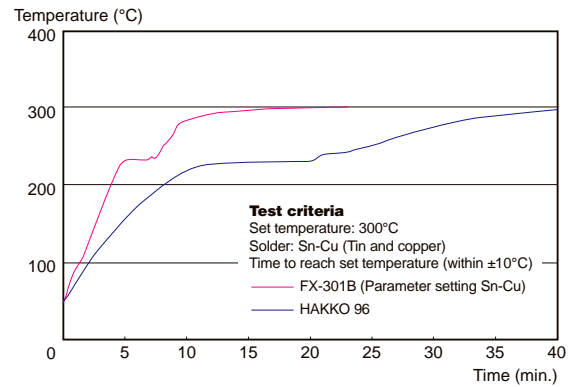

## FX-300

High Performance Soldering Pot

Analog



- Temperature can be adjusted just by turning a knob during operation.
- Adding an optional specially coated stainless-steel pot provides compatibility with lead-free solder.
- Time comparison to reach set temperature

FX-300 vs. HAKKO 96 (conventional model)

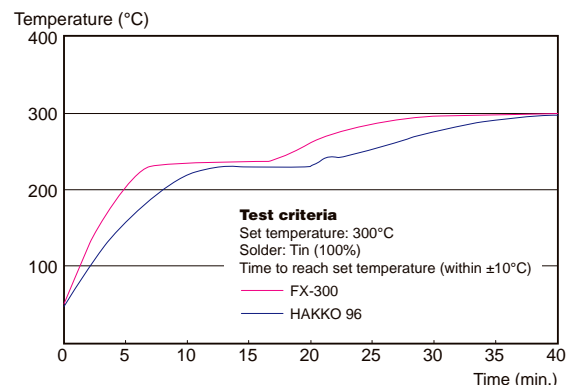

### Easy Pot Replacement



Loosen the screw on both sides.



Change the pot and tighten the screws.

\* For your safety, be sure to replace the pot after the solder completely cools.

### Specially Coated Solder Pot (Durable type)

The special coating prevents the solder pot from corroding, which ensures that the solder pot has a long service life.



Standard solder pot



Specially coated solder pot

### Dimensions of Solder Pot

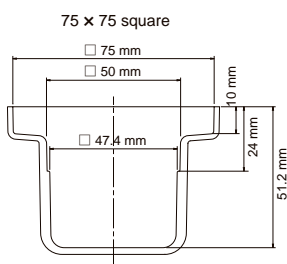
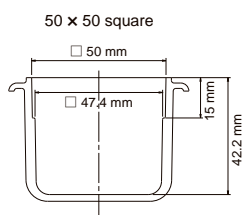

### Packing List

<b>FX-301B</b>	Unit (with solder pot, 50 x 50 durable type), Spatula, J-shaped waste collector, Hexagon wrench, Instruction manual
<b>FX-300</b>	Unit (with solder pot, 50 x 50), Spatula, J-shaped waste collector, Hexagon wrench, Instruction manual

### Specifications

<b>Model No.</b>	<b>FX-301B</b>
Power consumption	260 W
Dimensions	143 (W) x 100 (H) x 220 (D) mm
Weight*	1.7 kg

#### Pot

Temperature range	50 x 50 square: 200 to 450°C 75 x 75 square: 200 to 380°C
Dimensions of solder pot	50 x 50 square durable type: 50 (W) x 42.2 (H) x 50 (D) mm 75 x 75 square durable type: 75 (W) x 51.2 (H) x 75 (D) mm
Molten solder capacity**	50 x 50 square: 0.85 kg 75 x 75 square: 1.2 kg

<b>Model No.</b>	<b>FX-300</b>
Power consumption	205 W
Dimensions	143 (W) x 100 (H) x 220 (D) mm
Weight*	1.7 kg

#### Pot

Temperature range	50 x 50 square: 200 to 450°C 75 x 75 square: 200 to 380°C
Dimensions of solder pot	50 x 50 square standard type: 50 (W) x 42.2 (H) x 50 (D) mm 75 x 75 square standard type: 75 (W) x 51.2 (H) x 75 (D) mm
Molten solder capacity**	50 x 50 square: 0.85 kg 75 x 75 square: 1.2 kg

\* Without solder and cord

\*\* The 50 x 50 square solder pot is originally installed. The 75 x 75 square solder pot is an optional part.

### Option / Replacements

Part No.	Name	Specifications
A1539	Solder pot	50 x 50 durable type
A1540	Solder pot	75 x 75 durable type
A1517	Solder pot	50 x 50 standard type
A1518	Solder pot	75 x 75 standard type
A1310	Temperature probe	For solder bath and pot

### Temperature probe for soldering bath and pot

Possible to measure the temperature of solder with using thermometer and temperature probe.

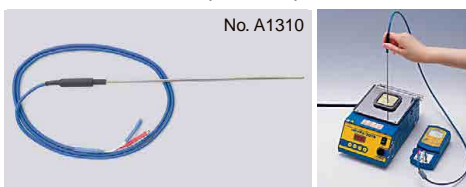

# 96

### Soldering Pot



• **Power consumption: 200 W**  
Please, visit HAKKO website for more information.

• **Dimensions of Solder Pot**

50 x 50 square

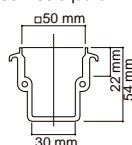

70 x 70 square

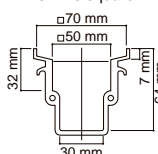

### Operation



## FR-301 Nozzle quick change type

### Portable Desoldering Tool

Nozzle included



- Power switch and adjustable temperature control built in the handle
- Use of high thermal efficiency N61 series nozzles
- Reduction of solder clogging by improved heating core (in comparison with the previous model)

### Packing List

FR-301	Unit, Pre-filter, Ceramic paper filter (L, qty 2), Nozzle wrench, Iron holder (simple type), Cleaning pin for heating core, Cleaning pin for $\phi 1$ mm nozzle, Instruction manual
--------	---



Provided in a carrying case

### Specifications

Model No.	FR-301
Power consumption	110 W (50/60 Hz)
Temperature range	350 to 500 °C
Nozzle to ground resistance	<2 $\Omega$
Nozzle to ground potential	<2 mV
Vacuum generator	Diaphragm pump
Vacuum pressure	81 kPa (610 mmHg)
Suction flow	11 L/min.
Heating element	Ceramic heater
Standard nozzle	$\phi 1$ mm (No.N61-08)
Dimensions	215 (W) $\times$ 226 (H) mm (with $\phi 1$ mm (No.N61-08) nozzle)
Weight*	0.52 kg (with $\phi 1$ mm (No.N61-08) nozzle)

\* Without cord

## Features

### Easy temperature control

LED indicators let you easily see when the heater is active and idling at your temperature setting.

- Temperature range
- Setting 1 350°C
  - Setting 2 400°C
  - Setting 3 450°C
  - Setting 4 500°C



### Quick change nozzle replacement with special tools

- Provided nozzle wrench

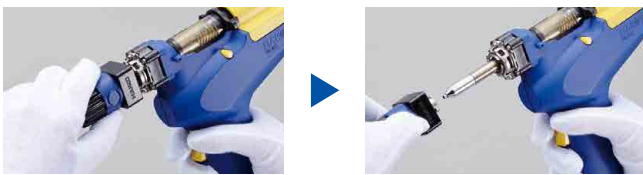

- Optional accessory Nozzle quick changer

Quick and safe nozzle replacement with nozzle quick changer  
 \* It can't be used for the previous model (FR-300).

Nozzle quick changer for FR-301: part No. C5046

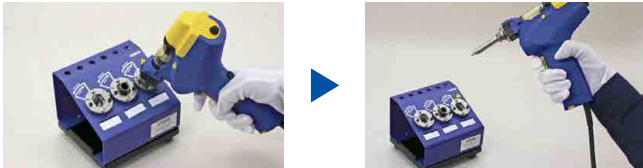

\* The positioning jig (No. B5231) is separately required for oval type nozzle.

### A wide selection of nozzles (N61 series)

SS type nozzles  
for micro land patterns



Oval shape nozzles  
for flat terminals



Long type nozzles  
for narrow space



### Reduction of solder clogging by improved heating core

This additional guard prevents a temperature drop of the heating core by making contact with the front holder and it enables to reduce solder clogging.

\* In comparison with the previous model

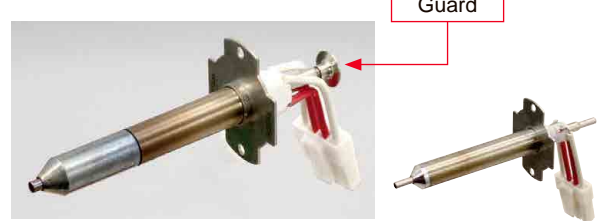

Heating core of the previous product (FR-300)

## Replacement Nozzles

Unit : mm

<b>SS type</b>	<b>N61-01</b>	<b>N61-02</b>	<b>N61-03</b>	
<b>S type</b>	<b>N61-04</b>	<b>N61-05</b>	<b>N61-06</b>	
<b>Standard type</b>	<b>N61-07</b>	<b>N61-08</b>	<b>N61-09</b>	<b>N61-10</b>
<b>Long type</b>	<b>N61-11</b>	<b>N61-12</b>	<b>N61-13</b>	<b>N61-14</b>
<b>Oval type</b>	<b>N61-15</b>	<b>N61-16</b>		

\* N61 series nozzles can also be used for FR-410 desoldering station.

## FR-400 ESD SAFE

Nozzle quick change type



Heavy Duty Desoldering Tool **Digital**

Nozzle included

Power Consumption  
**300 W**



- 300 W heavy duty desoldering tool with built-in vacuum pump
- Secure desoldering with valve function
- Reduction of solder clogging
- Improvement in maintainability

## FR-410 ESD SAFE

Nozzle quick change type



High-Power Desoldering Tool **Digital**

Nozzle included

Power Consumption  
**140 W**



- 140 W high power enables perfect desoldering for the components on multi-layer P.W.B.
- A wide selection of nozzles is available for a variety of desoldering works.



### Feature of FR-400

300 W tremendous power makes incredible heating.

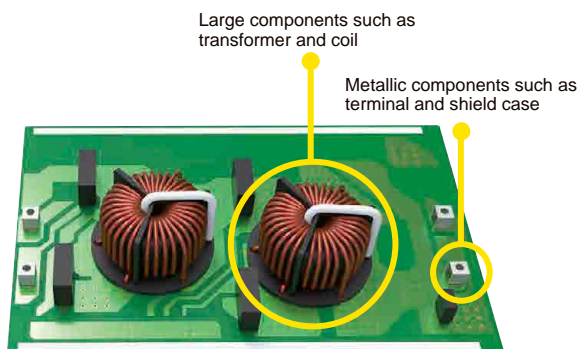

### Feature of FR-410

A wide selection of nozzles is available for a variety of desoldering works.

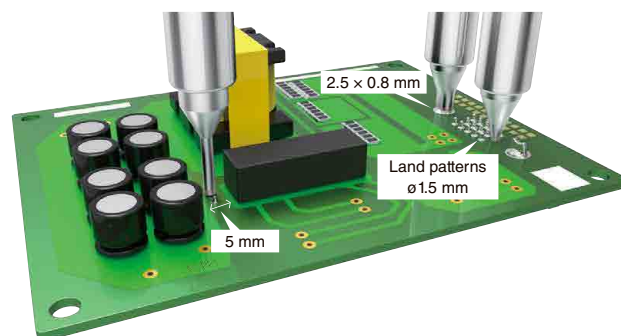

### Common Features of FR-400 and FR-410

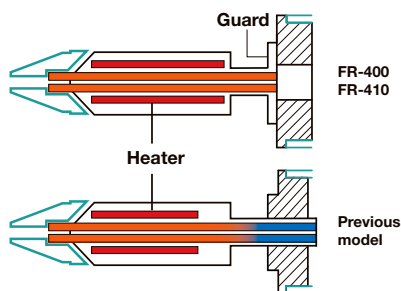

#### Secure desoldering, valve function that suctions with high pressure

Suction starts 0.2 seconds after pulling the trigger for instance and high pressure suction to achieve complete desoldering.

#### Improvement in heating core

Heating ability for backside of heating core is increased to ensure suctioned solder be carried to filter pipe and avoid solder clogging.

#### Featuring ACF (Anti Clogging Function)

ACF ensures suctioned solder be carried to filter pipe by keeping pump running for a second after releasing trigger.

#### Reduction of solder clogging by improved heating core

The additional guard prevents a temperature drop of the heating core by making contact with the front holder and it enables to reduce solder clogging.

\* In comparison with the previous model

### Improvement in maintainability

- Easy heater replacement
- Tool box for maintenance kit



By removing 3 screws



#### ■ Quick change nozzle replacement with optional accessory

Quick and safe nozzle replacement with nozzle quick changer

\* It can't be used for previous desoldering tools (FR-4001 or FR-4101).

Nozzle quick changer for FR-4003: Part No. C5045

Nozzle quick changer for FR-4103: Part No. C5046



\* The positioning jig below is separately required for oval type nozzle.

Oval nozzle positioning jig: part No.B5229 for FR-4003  
part No.B5230 for FR-4103

### Packing List

<b>FR-400</b>	Station, Desoldering tool (FR-4003), Power cord, Iron holder (with cleaning wire), Tool box (Cleaning pin for ø1 mm, Cleaning pin for heating element, Cleaning drill for ø1 mm, Nozzle wrench, Filter [qty 2], Ceramic paper filter [qty 4]), Instruction manual
<b>FR-410</b>	Station, Desoldering tool (FR-4103), Power cord, Iron holder (with cleaning wire), Tool box (Cleaning pin for ø1 mm, Cleaning pin for heating element, Cleaning drill for ø1 mm, Nozzle wrench, Filter [qty 2], Ceramic paper filter L [qty 4]), Instruction manual

### Specifications

Model No.	FR-400	FR-410
Power consumption	320 W	190 W
Temperature range	350 to 500 °C	330 to 450 °C
Temperature stability	±5 °C at idle temperature	±5 °C at idle temperature

#### Station

	FR-400	FR-410
Output voltage	AC 29 V	AC 24 V
Vacuum generator	Vacuum pump, double cylinder type	Vacuum pump, double cylinder type
Vacuum pressure	80 kPa (600 mmHg, max.)	80 kPa (600 mmHg, max.)
Suction flow*	15 L / min.	15 L / min.
Dimensions	166 (W) × 137 (H) × 264 (D) mm	165 (W) × 137 (H) × 244 (D) mm
Weight	5.7 kg	4.8 kg

#### Desoldering Tool

	FR-400	FR-410
Power consumption	300 W (29 V)	140 W (24 V)
Nozzle to ground resistance	<2 Ω	<2 Ω
Nozzle to ground potential	<2 mV	<2 mV
Heating element	Composite heater	Composite heater
Standard nozzle	ø1 mm (No. N60-02)	ø1 mm S type (No. N61-05)
Cord length	1.2 m	1.2 m
Total length**	183 mm (with ø1 mm nozzle)	168 mm (with ø1 mm S type nozzle)
Weight**	270 g (with ø1 mm nozzle)	190 g (with ø1 mm S type nozzle)

\* The suction flow is measured at the filter case suction port of station.

\*\* Without cord and hose

# Desoldering Tool

## Replacement Nozzles for FR-400

Unit : mm

<b>N60-01 Nozzle <math>\phi 0.8</math></b> 	<b>N60-02 Nozzle <math>\phi 1</math></b> 	<b>N60-03 Nozzle <math>\phi 1.3</math></b> 	<b>N60-04 Nozzle <math>\phi 1.6</math></b> 	<b>N60-05 Nozzle <math>\phi 2</math></b> 
<b>N60-06 Nozzle <math>\phi 2.6</math></b> 	<b>N60-07 Nozzle <math>\phi 3</math></b> 	<b>N60-08 Nozzle 4.2 x 1.5</b> 	<b>N60-09 Nozzle 6.2 x 1.5</b> 	

## Replacement Nozzles for FR-410

Unit : mm

<b>SS type</b> N61-01 	<b>N61-02</b> 	<b>N61-03</b> 		
<b>S type</b> N61-04 	<b>N61-05</b> 	<b>N61-06</b> 		
<b>Standard type</b> N61-07 	<b>N61-08</b> 	<b>N61-09</b> 	<b>N61-10</b> 	
<b>Long type</b> N61-11 	<b>N61-12</b> 	<b>N61-13</b> 	<b>N61-14</b> 	
<b>Oval type</b> N61-15 	<b>N61-16</b> 	<p>* N61 series nozzles can also be used for FR-301 desoldering tool.</p>		

# FM-204 ESD SAFE

## Composite-type Desoldering Tool Digital

Nozzle not included



- Vacuum pump built-in type desoldering tool
- Digital display ensures easy and reliable temperature control.
- Sleep function that works with iron holder prevents nozzle oxidation.

### Packing List

FM-204	Station, Iron holder, Ceramic paper filter (10 pcs), Cleaning drill for heating element, Filter pipe assembly (1 pc), Control card, Power cord, Connecting cable, Nozzle remover, Desoldering tool (FM-2024), Handle for gun configuration, Instruction manual
--------	--

### Specifications

Model No.	FM-204
Power consumption	120 W
Temperature range	FM-2024: 350 to 450°C FM-2026/2027: 200 to 450°C
Temperature stability	±5°C at idle temperature

#### Station

Output voltage	AC 24 V
Vacuum generator	Vacuum pump, double cylinder type
Vacuum pressure	80 kPa (600 mmHg, max.)
Suction flow*	15 L/min.
Dimensions	160 (W) × 120 (H) × 225 (D) mm
Weight	3.7 kg

#### Desoldering Tool

Power consumption	70 W (24 V)
Nozzle to ground resistance	<2 Ω
Nozzle to ground potential	<2 mV
Heating element	Composite heater
Cord length	1.2 m
Total length**	180 mm (with ø1 mm nozzle)
Weight**	65 g (with ø1 mm nozzle)

\* Measured at the filter case suction port of the station.

\*\* Without cord and hose

### Features

Replacing the handpiece enables soldering.

■ Soldering

■ N<sub>2</sub> System (P.38 & P.39)



Set-up example  
FM-204  
FM-2026  
FX-780  
FX-791

### Optional Nozzles for FM-204

Unit : mm

<b>N3-06 Nozzle ø0.6</b> 	<b>N3-08 Nozzle ø0.8</b> 	<b>N3-10 Nozzle ø1</b> 	<b>N3-13 Nozzle ø1.3</b> 	<b>N3-16 Nozzle ø1.6</b> 
<b>N3-20 Nozzle ø2</b> 	<b>N3-23 Nozzle ø2.3</b> 	<b>N3-L10 Nozzle ø1 long</b> 		

## SPPON

### Desoldering Tool

Nozzle included



- Light-weight and simplified desoldering tool with high suction power
- Use a cleaning shaft that enables the nozzle to be cleaned after each use
- Nozzles can be easily replaced.

#### Replacement Nozzles

Unit : mm

Part No.	Figure	Adaptation products
18-N		No.18, 18G
20-N		No.20, 20G
DS01-N		No.DS01P

#### Specifications

Part No.	Absorption capacity
18	12 cm <sup>3</sup> (12 cc)
18G	12 cm <sup>3</sup> (12 cc) with guard
20	20 cm <sup>3</sup> (20 cc)
20G	20 cm <sup>3</sup> (20 cc) with guard
DS01P	28 cm <sup>3</sup> (28 cc)

## WICK

### Desoldering Wire



- Economical and easy-to-use desoldering wire
- ESD SAFE package

#### Features

##### Through-hole solder removal



##### Bridging solder removal

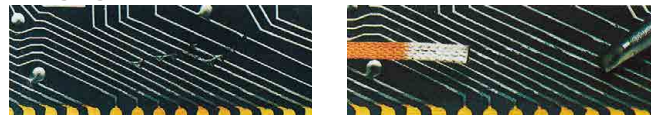

#### Specifications for FR-150

Flux type	ROL0 (IPC J-STD-004)
Halide content	0.00% (JIS Z 3197)
Copper plate corrosion	pass (JIS Z 3197)

#### Size

##### No clean type (halogen free)

Part No.	Description
FR150-81	0.7 mm x 1.5 m
FR150-82	1 mm x 1.5 m
FR150-83	1.5 mm x 1.5 m
FR150-84	2 mm x 1.5 m
FR150-85	2.5 mm x 1.5 m
FR150-86	3 mm x 1.5 m

##### Unflux type (unflux)

Part No.	Description
FR140-81	0.7 mm x 1.5 m
FR140-82	1 mm x 1.5 m
FR140-83	1.5 mm x 1.5 m
FR140-84	2 mm x 1.5 m
FR140-85	2.5 mm x 1.5 m
FR140-86	3 mm x 1.5 m

## FR-830 ESD SAFE

Preheater **Analog**



- Compact pre-heater best suited for heat processing on localized areas
- Featuring quick heatup and less variations in temperature

### Features

#### Preheating in a short time

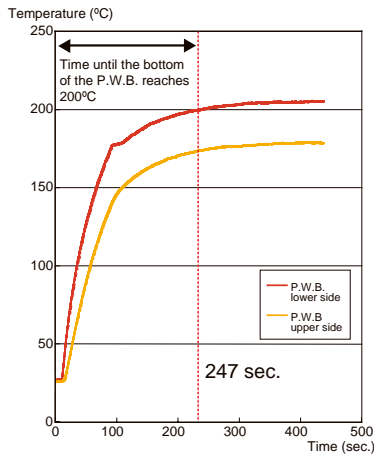

#### Test criteria

Measurement method	Temperature measured using sensors mounted on both the top and bottom surfaces of the P.W.B.
Distance between air outlet and P.W.B.	10 mm
Temperature setting	300°C

#### Set up example with omnivise

- The height can be adjusted to 72.5 mm, 78 mm, 84.5 mm, 91 mm and 97.5 mm.
- The jaws are padded to preclude damage to delicate objects.
- Full rotations of 360° are available without interference.



### Packing List

FR-830	Unit, Power cord, Instruction manual
--------	--------------------------------------

### Specifications

Model No.	FR-830
Power consumption	250 W
Air flow	0.15 m <sup>3</sup> /min. (fan capability)
Temperature range	150 to 300°C (above the hot air outlet)
Dimensions*	140 (W) × 75 (H) × 185 (D) mm
Weight	0.75 kg

\* The height (H) is the distance from the bottom of the feet to the top of the exhaust outlet.

### Option

Part No.	Name	Specifications
B3263	Extension pipe	with lid
B2763	Hand switch	–
B1649	Foot switch	–
C1390C	Omnivise	qty 1

## FR-810B ESD SAFE

Hot-Air SMD Rework Station **Digital**

Nozzle included



- High volume airflow and high output for a various kinds of rework
- Full digital control of temperature, airflow, and time
- Simple nozzle removal and easy maintenance
- The vacuum pick-up function with an indicator ensures safety for the components and P.W.B.

## FR-811 ESD SAFE

Hot-Air SMD Rework Station **Digital**

Nozzle not included



- Possible to make full-scale thermal profiles with 6-zone hot air and a bottom heater
- Possible to measure and record temperature of components and P.W.B. with type K thermocouple
- The dedicated software to link a station and a computer for easy and quick settings
- Easy data transfer through an USB cable

## Common Features of FR-810B and FR-811

### New user friendly functions for SMD rework

#### Pickup indicator

The indication comes up and the moment of picking up will be visible.



#### Vacuum pickup function

This can avoid an error to peel off the land by removing components with excessive force.



#### New type of nozzles

The new nozzles improve work efficiency with uniform heating (only with BGA nozzles).

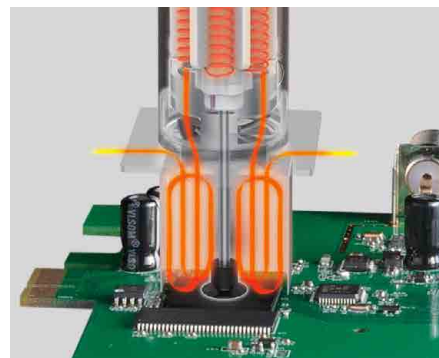

### Efficiency improvement

The high volume airflow and high output of FR-810B and FR-811 make it possible to perform the same work in only one-third of the time required when using a conventional model. This reduces the thermal impact on boards and components.

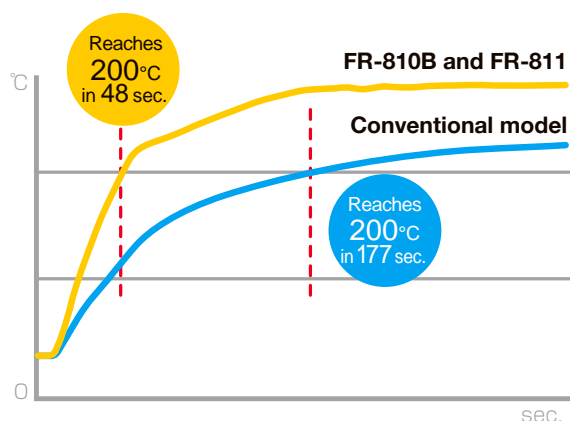

#### Test criteria

Model	FR-810B	Conventional model
Measurement method	Examination of time taken for connector sections soldered onto a ceramic board to be heated 200°C	
Board	Ceramic board	
Component used	Connector	
Nozzle shape	N51-02	A1130
Temperature setting	600°C	500°C
Air flow setting	9 (115 L/min.)	20 L/min.

### Quick-change N51 nozzles



### Simple heater replacement



## Specifications

Port No.	FR-810B	FR-811
Power consumption	1200 W	
Temperature range	50 to 600°C	

### Station

Power consumption	30 W	
Air flow*	1 to 9 (5 to 115 L/min.)	001 to 100% (5 to 115 L/min.)
Dimensions	160 (W) × 145 (H) × 220 (D) mm	
Weight	1.5 kg	

### Handpiece

Power consumption	1170 W	
Standard nozzle	ø4 mm (No. N51-02)	—
Total length**	250 mm	
Weight**	180 g	

\* Airflow capacity is rated as free flowing. Restrictions created by various nozzles may reduce the maximum airflow capacity.

\*\* Without cord

## Packing List

<b>FR-810B</b>	Station with handpiece, Nozzle (ø4 mm), Handpiece holder, Vacuum pipe control knob L (with screw), Pads (qty 2 each of ø3 mm, ø5 mm, ø7.6 mm), Heat resistant pad, Power Cord, Temperature distribution chart, Instruction manual
<b>FR-811</b>	Station with handpiece, Grip stand assembly, Vacuum pipe control knob L (with screw), Pads (qty 2 each of ø3 mm, ø5 mm, ø7.6 mm), USB cable, Software (CD-ROM), Thermocouple, Heat resistant pad, Power Cord, Temperature distribution chart, Instruction manual

## Option

Part No.	Name	Specifications
C5027	Board holder	—
C5028	Grip fixture M	With hexagon wrench, o-ring and tray
C5029	Grip fixture L	With hexagon wrench and o-ring
B5098	Board clip	—
B5136	Board support unit	—
C5013*	Bottom heater	For FR-811

\* Please ask about correct part number to the nearest HAKKO dealer or distributor in your area.

# Hot-Air SMD Rework Station

## Common Features of FR-810B and FR-811

### Auto sleep and auto shutoff features

To ensure safety and conserve power, when the handpiece is placed in the handpiece holder, the auto sleep function is activated and it starts cooling automatically. If the handpiece has not been removed from the handpiece holder (example: using it in a rework fixture) and after it has been idle for 30 minutes, auto shutoff function is activated. It is automatically powered off. Access to settings can be restricted via the password function for easy management.



Handpiece holder No.B5048 in the picture can be attached to FR-811 as well (option).

### Preset mode

	Preset 1	Preset 2	Preset 3	Preset 4	Preset 5
Temperature (°C)	250	300	350	400	450
Time (sec.)	100	80	50	120	150
Airflow (level)	6	7	8	4	5

### Chain presets function for making a simple thermal profile

The chain presets function is to make a simple thermal profile by combining several preset conditions (up to 5 steps).

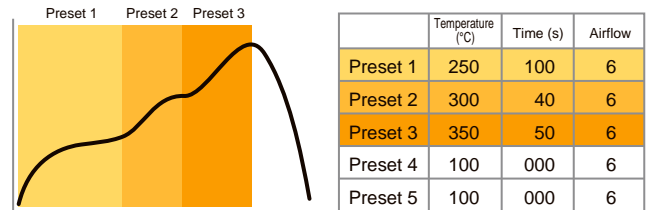

\* Presets 4 and 5 have been set to "000", so they are skipped.

## Features of FR-811

Interface designed for intuitive operation. Possible to link to a PC.



Easy-to-read LCD



Easy-to-operate multi-direction control knob



A USB device terminal for easy data transfer



Link to a PC (A USB I/F terminal available)



**The functions needed for SMD rework are in a compact body.**

**Possible to make full-scale thermal profiles with 6-zone hot air and a bottom heater**

A basic thermal profile is composed of the 5 parts shown below. FR-811 can provide 6 zones in which temperature, time, and airflow are controlled. Therefore FR-811 can make a full-scale thermal profile which is close to reflow profiles made by a reflow oven.

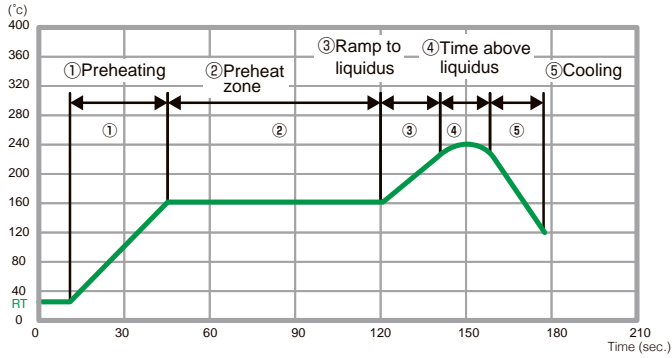

**Record thermal data**

By connecting a thermocouple included with FR-811, the temperature of the component or circuit board can be measured and recorded. In addition, if "TC LINK" is set, the heater output can be automatically controlled so that the temperature of the thermocouple attached to the component or circuit board follows the set profile.



**Operation on a PC for various settings**

By connecting FR-811 and a computer with a USB cable and using the dedicated software which comes as standard, a set thermal profile and actual temperature change can be shown in a graph in real time. The set values and graph can be saved in csv format.

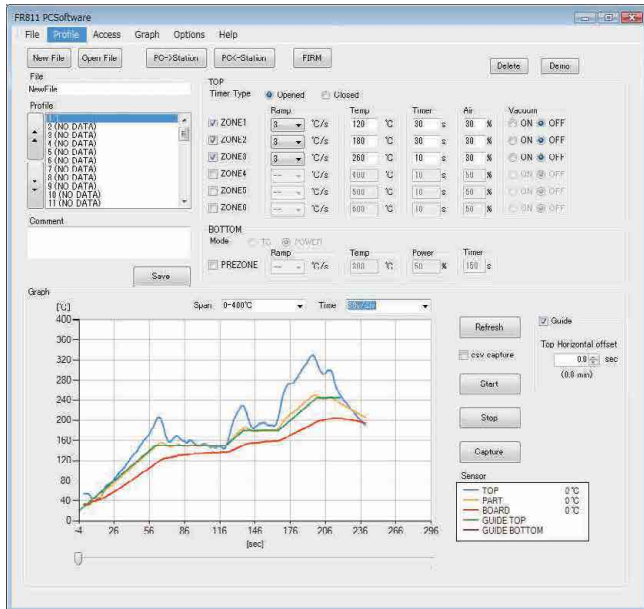

**Linked operation with the bottom heater**

FR-811 can control on/off timing and output of the bottom heater which is available optionally.



# Hot-Air SMD Rework Station

## Common Features of FR-810B and FR-811

### Assembly of a low-cost SMD rework system

A low cost rework system can be assembled with a bottom heater, a grip fixture, and a board holder.

\* The following pictures are set-up examples.



## Option

### Grip Fixture L



A board holder can be easily attached to the large baseplate.

### Grip Fixture M



Recommended if a bottom heater is not required or in case of use of a bottom heater other than the dedicated model for FR-811.

### The dedicated bottom heater for FR-811



Equipped with carbon heaters. Heating area is divided into 2 sections.

### Board Holder



Makes it easy to set and remove a P.W.B. and to make fine adjustments after setting.

### Board Clip

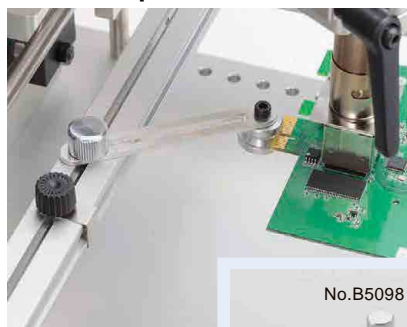

Accepts even irregular-shaped P.W.B.

### Board Support Unit

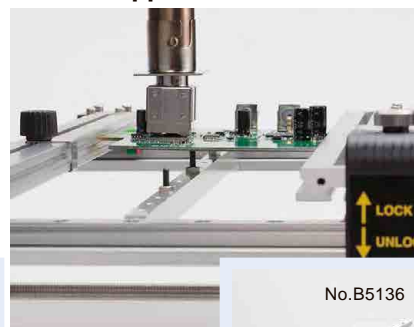

Supports P.W.B. from underneath to minimize its warping.

**Option**

**Temperature probe for hot air station**

Possible to measure the temperature of hot air with using thermometer and temperature probe. It is also possible to measure the temperature of workpieces with using thermometer and Sensor B (No. A1557) which comes with No. C1541.



**Optional Nozzles (Quick-change type) for FR-810B, FR-811 and FR-702**

Unit: mm

Single	N51-01* Single 2.5	N51-02 Single 4	N51-03 Single 5.5	N51-04 Single 7	N51-05* Bent Single 1.5 x 3
BGA	N51-10 BGA 4 x 4	N51-11 BGA 6 x 6	N51-12 BGA 8 x 8	N51-13 BGA 10 x 10	N51-14 BGA 12 x 12
	N51-15 BGA 14 x 14	N51-16 BGA 15 x 15	N51-17 BGA 17 x 17	N51-18 BGA 18 x 18	N51-19 BGA 20 x 20
	N51-20 BGA 22 x 22	N51-21 BGA 24 x 24	N51-22 BGA 27 x 27	N51-23 BGA 29 x 29	N51-24 BGA 35 x 35
	N51-25 BGA 38 x 38	N51-26 BGA 40 x 40			

\* The vacuum function does not operate with these nozzles.

Single nozzle set (N51-01, N51-03, N51-04, and N51-05) is also available.

\* N51-02 included with FR-810B



# Hot-Air SMD Rework Station

## Optional Nozzles (Conventional type) for FR-810B, FR-811 and FR-702

Unit: mm

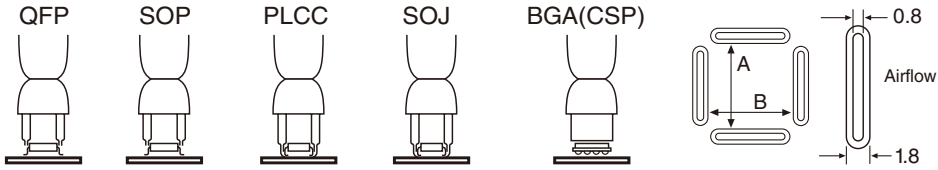

The size in each description indicates the size of the package.

### QFP and BQFP

<b>A1125B QFP 10 × 10</b>  A: 10.2 B: 10.2	<b>A1262B QFP 12 × 12</b>  A: 12.2 B: 12.2	<b>A1126B QFP 14 × 14</b>  A: 15.2 B: 15.2	<b>A1128B QFP 14 × 20</b>  A: 15.2 B: 21.2	<b>A1127B QFP 17.5 × 17.5</b>  A: 19.2 B: 19.2
<b>A1261B QFP 20 × 20</b>  A: 20.2 B: 20.2	<b>A1129B QFP 28 × 28</b>  A: 29.7 B: 29.7	<b>A1263B QFP 28 × 40</b>  A: 27.7 B: 39.7	<b>A1265B QFP 32 × 32</b>  A: 32.2 B: 32.2	<b>A1203B QFP 35 × 35</b>  A: 35.2 B: 35.2
<b>A1264B QFP 40 × 40</b>  A: 40.2 B: 40.2	<b>A1215B QFP 42.5 × 42.5</b>  A: 42.5 B: 42.5	<b>A1180B BQFP 17 × 17</b>  A: 18.2 B: 18.2	<b>A1181B BQFP 19 × 19</b>  A: 19.2 B: 19.2	<b>A1182B BQFP 24 × 24</b>  A: 24.2 B: 24.2



### SOP and TSOL

<b>A1131* SOP 4.4 × 10</b>  4.8	<b>A1132* SOP 5.6 × 13</b>  5.7	<b>A1133* SOP 7.5 × 15</b>  7.2	<b>A1134* SOP 7.5 × 18</b>  7.2	<b>A1258B SOP 7.6 × 12.7</b>  8.2
<b>A1260B SOP 8.6 × 18</b>  8.7	<b>A1257B SOP 11 × 21</b>  11.7	<b>A1259B SOP 13 × 28</b>  13.5	<b>A1185B TSOL 13 × 10</b>  11.9	<b>A1186B TSOL 18 × 10</b>  18.2
<b>A1187B TSOL 18.5 × 8</b>  18.5				









### PLCC

<b>A1188B PLCC 9 × 9 (20 pins)</b>  A: 11 B: 11	<b>A1140B PLCC 11.5 × 11.5 (28 pins)</b>  A: 13 B: 13	<b>A1141B PLCC 11.5 × 14 (32 pins)</b>  A: 15 B: 13	<b>A1139B PLCC 12.5 × 7.3 (18 pins)</b>  A: 9 B: 14	<b>A1135B PLCC 17.5 × 17.5 (44 pins)</b>  A: 18.5 B: 18.5
<b>A1136B PLCC 20 × 20 (52 pins)</b>  A: 21 B: 21	<b>A1137B PLCC 25 × 25 (68 pins)</b>  A: 26 B: 26	<b>A1138B PLCC 30 × 30 (84 pins)</b>  A: 31 B: 31	<b>A1189B PLCC 34 × 34 (100 pins)</b>  A: 36.5 B: 36.5	





SOJ

<p><b>A1214B SOJ 10 x 26</b></p> 	<p><b>A1183* SOJ 15 x 8</b></p> 	<p><b>A1184B SOJ 18 x 8</b></p> 
--	---	---

BGA

<p><b>A1470 BGA 8 x 8</b></p> 	<p><b>A1471 BGA 12 x 12</b></p> 	<p><b>A1472 BGA 13 x 13</b></p> 	<p><b>A1473 BGA 15 x 15</b></p> 	<p><b>A1474 BGA 18 x 18</b></p> 
<p><b>A1475 BGA 27 x 27</b></p> 	<p><b>A1476 BGA 35 x 35</b></p> 	<p><b>A1477 BGA 38 x 38</b></p> 	<p><b>A1478 BGA 40 x 40</b></p> 	

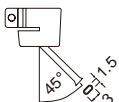
Single

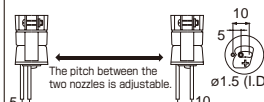
<p><b>A1124B* Single 2.5</b></p> 	<p><b>A1130* Single 4.4</b></p> 	<p><b>A1142B* Bent single 1.5 x 3</b></p> 	<p><b>A1190* Dual single 2.5 x 9.5</b></p> 	<p><b>A1325* Dual single ø1.5 x 5 to 10 Adjustable pitch</b></p> 
--	---	--	--	---

SIP

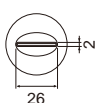
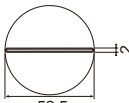
<p><b>A1191* SIP 25L</b></p> 	<p><b>A1192* SIP 50L</b></p> 
--	--

\* The vacuum function does not operate with these nozzles.

## FR-701

ESD SAFE

Nozzle quick change type

Repair System

Digital



- All-in-one repair system that enables both soldering and desoldering

### Features

For information on features of soldering iron, see P. 33.  
For information on features of desoldering tool, see P. 71.

**NOTE:** Auto Shutoff Function and Auto Sleep Function are available for desoldering tool only.

### Packing List

<b>FR-701</b>	Station, Soldering iron (FX-8801), Desoldering tool (FR-4103), Iron holder for soldering iron (with cleaning sponge and wire), Iron holder for desoldering tool (with cleaning wire), Tool box (Cleaning pin for $\phi 1$ mm, Cleaning pin for heating element, Cleaning drill for $\phi 1$ mm, Nozzle wrench, Filter [qty 2], Ceramic paper filter L [qty 4]), Power cord, Instruction manual
---------------	--

### Replacement Tips and Nozzles

For information on optional irons and replacement tips, see P. 35 to 37.  
For information on replacement nozzles for desoldering tool FR-4103, see P. 72.

### Specifications

Part No.	FR-701
Power consumption	260 W

#### Station (Soldering iron)

Output voltage	AC 26 V
Temperature range	50 to 480°C
Temperature stability	$\pm 1^\circ\text{C}$ at idle temperature (when set to 200 to 480°C)

#### Station (Desoldering tool)

Output voltage	AC 24 V
Vacuum generator	Vacuum pump, double cylinder type
Vacuum pressure	80 kPa (600 mmHg, max.)
Suction flow	15 L/min.
Temperature range	330 to 450°C
Temperature stability	$\pm 5^\circ\text{C}$ at idle temperature

#### Station

Dimensions	190 (W) × 140 (H) × 220 (D) mm
Weight	6.2 kg

#### Soldering iron

Power consumption	65 W (26 V)
Tip to ground resistance	$< 2 \Omega$
Tip to ground potential	$< 2$ mV
Heating element	Ceramic heater
Standard tip	Shape-B (No. T18-B)
Cord length	1.2 m
Total length*	217 mm (with B tip)
Weight*	46 g (with B tip)

#### Desoldering tool

Power consumption	140 W (24 V)
Nozzle to ground resistance	$< 2 \Omega$
Nozzle to ground potential	$< 2$ mV
Heating element	Composite heater
Standard nozzle	$\phi 1$ mm S type (No. N61-05)
Cord length	1.2 m
Total length**	168 mm (with $\phi 1$ mm S type nozzle)
Weight**	190 g (with $\phi 1$ mm S type nozzle)

\* Without cord

\*\* Without cord and hose

## FR-702

ESD SAFE

Nozzle quick change type

Rework System

Digital



- Multi-station that enables soldering, desoldering, and SMD rework all with a single unit

### Features

For information on features of soldering iron, see P. 33.  
 For information on features of desoldering tool, see P. 71.  
 For information on features of hot air, see P. 77 to 78 (common features).  
**NOTE:** Auto Shutoff Function and Auto Sleep Function are available for desoldering tool and hot air only.  
 Low Temperature Error Alert is available for soldering iron and desoldering tool only.

### Packing List

<b>FR-702</b>	Station with hot air handpiece, Nozzle (ø4 mm) for hot air, Handpiece holder for hot air, Vacuum pipe control knob L (with screw), Pads (qty 2 each of ø3 mm, ø5 mm, ø7.6 mm), Soldering iron (FX-8801), Desoldering tool (FR-4103), Iron holder for soldering iron (with cleaning sponge and wire), Iron holder for desoldering tool (with cleaning wire), Tool box (Cleaning pin for ø1 mm, Cleaning pin for heating element, Cleaning drill for ø1 mm, Nozzle wrench, Filter [qty 2], Ceramic paper filter L [qty 4]), Heat resistant pad, Color band (qty 2), Power cord, Instruction manual
---------------	--

### Replacement Tips and Nozzles

For information on optional irons and replacement tips, see P. 35 to 37.  
 For information on replacement nozzles for desoldering tool FR-4103, see P. 72.  
 For information on replacement nozzles for hot air, see P. 81 to 83.

### Specifications

<b>Part No.</b>	<b>FR-702</b>
Power consumption	1530 W

#### Station (Soldering iron)

Output voltage	AC 26 V
Temperature range	50 to 480°C
Temperature stability	±1°C at idle temperature (when set to 200 to 480°C)

#### Station (Desoldering tool)

Output voltage	AC 24 V
Vacuum generator	Vacuum pump, double cylinder type
Vacuum pressure	80 kPa (600 mmHg, max.)
Suction flow	15 L/min.
Temperature range	330 to 450°C
Temperature stability	±5°C at idle temperature

#### Station (SMD rework station)

Power consumption	30 W
Air flow*	1 to 9 (5 to 115 L/min.)
Temperature range	50 to 600°C

#### Station

Dimensions	370 (W) × 150 (H) × 220 (D) mm
Weight	9 kg

#### Soldering Iron

Power consumption	65 W (26 V)
Tip to ground resistance	<2 Ω
Tip to ground potential	<2 mV
Heating element	Ceramic heater
Standard tip	Shape-B (No. T18-B)
Cord length	1.2 m
Total length**	217 mm (with B tip)
Weight**	46 g (with B tip)

#### Desoldering tool

Power consumption	140 W (24 V)
Nozzle to ground resistance	<2 Ω
Nozzle to ground potential	<2 mV
Heating element	Composite heater
Standard nozzle	ø1 mm S type (No. N61-05)
Cord length	1.2 m
Total length***	168 mm (with ø1 mm S type nozzle)
Weight***	190 g (with ø1 mm S type nozzle)

#### Handpiece (Hot air)

Power consumption	1170 W (230 V)
Standard nozzle	ø4 mm (No. N51-02)
Total length**	250 mm
Weight**	180 g

\* Airflow capacity is rated as free flowing. Restrictions created by various nozzles may reduce the maximum airflow capacity.

\*\* Without cord.

\*\*\* Without cord and hose.

## 442B

### Wrist Strap



- This antistatic wrist strap prevents the human body from becoming charged with static electricity.
- The stretchable band is easy to adjust.
- A conductive thread is used for the band lining.

### Specifications

Part No.	442B-01	442B-02	442B-04	442B-05	442B-06	442B-07
Color	Blue		Light green		Gray	
Grounding wire	1.5 m	2.5 m	1.5 m	2.5 m	1.5 m	2.5 m

## FG-470

### Wrist Strap Tester



- Easy-to-use, quick-response tester for wrist straps
- A user-friendly pad secures pass/fail judgement on a wrist strap.
- Highly visible LED lamps and buzzer will indicate test result.

\* Buzzer sounds only for "PASS".

### Features

#### Connection patterns to choose depending on wrist straps

\* Banana plug and grounding wire are included in FG-470.



#### Dedicated holder included

A mounting holder can make it easy to plug and unplug even with one hand. No tool is required to remove a unit. A unit can be portable off the holder.



\* Example of installation



\* 4 Wood screws provided

### Packing List

FG-470	Unit, 006P 9 V dry battery (for trial), Grounding wire, Banana plug, Mounting holder, Wood screws (qty 4), Instruction manual
--------	---

### Specifications

Model No.	FG-470	
Power supply	006P 9 V dry battery (alkaline cell recommended)	
Indication	LOW	$R < 800 \text{ k}\Omega$
	PASS	$800 \text{ k}\Omega \leq R \leq 9 \text{ M}\Omega$
	HIGH	$R > 9 \text{ M}\Omega$
Judgment level accuracy	800 k $\Omega$	+ 10% / - 0%
	9 M $\Omega$	+ 0% / - 10%
Battery life	Approx. 50,000 times (9 V alkaline)	
Grounding wire	1 m	
Operating environment	Ambient temperature/Humidity range: 0 to 40°C, max.80% RH (without condensation)	
External dimensions	85 (W) × 44 (H) × 90 (D) mm	
	With mounting holder 92 (W) × 48 (H) × 97 (D) mm	
Weight*	120 g	
	With mounting holder 160 g	

\* Without battery



## FG-465 New

### Footwear Tester



- Saves measurement data automatically
- Meets the requirement of JIS T 8103 : 2010
- Personal information can be registered in ID

#### Specifications

<b>Model No.</b>		FG-465
<b>Rating</b>		24 VDC 50 mA
<b>Measurement voltage</b>		20 VDC
<b>Measurement range</b>	<b>Upper evaluation limit</b>	1000 MΩ (1×10 <sup>9</sup> Ω)
		100 MΩ (1×10 <sup>8</sup> Ω)
		10 MΩ (1×10 <sup>7</sup> Ω)
	<b>Lower evaluation limit</b>	1 MΩ (1×10 <sup>6</sup> Ω)
		0.1 MΩ (1×10 <sup>5</sup> Ω)
<b>Conductivity evaluation</b>	R < 0.1 MΩ (1×10 <sup>5</sup> Ω)	
<b>Evaluation level accuracy</b>	R < 0.1 MΩ	± 5%
	0.1 MΩ ≤ R ≤ 100 MΩ	± 10%
	100 MΩ < R	± 8%
<b>Operating environment</b>		Ambient temperature/Humidity range: 0 to 40°C, max.80% RH (without condensation)
<b>Environment condition</b>		Applicable rated pollution degree 2 (according to IEC / UL61010-1)
<b>Dimensions</b>		120 (W) × 30 (H) × 185 (D) mm
<b>Weight*</b>		0.55 kg

#### Test plate

<b>Cord length</b>	1.6 m
<b>Dimensions**</b>	300 (W) × 30 (H) × 300 (D) mm
<b>Weight**</b>	1.9 kg

#### AC adapter

<b>Output voltage</b>	24 VDC
-----------------------	--------

\* Including mounting base

\*\* Without cord

#### Packing List

<b>FG-465</b>	Unit, Test plate, Mounting base, Knob (qty 2), Wood screw (qty 2), Pan head screw (qty 2), AC adapter*, USB cable, Instruction manual
---------------	---

\* AC adapter may not be included depending on the specifications.

#### Option

Part No.	Name
C5032	Stand
B5263	Unit integration base

#### Stand

No.C5032



#### Unit integration base (Connecting cable included)

No.B5263



An option part to integrate FG-465 and FG-470 is available.

# Footwear Tester

## Features

### Dual foot plate

FG-465 measures anti-static performance of footwear on both feet but individually, and shows the results for each foot.

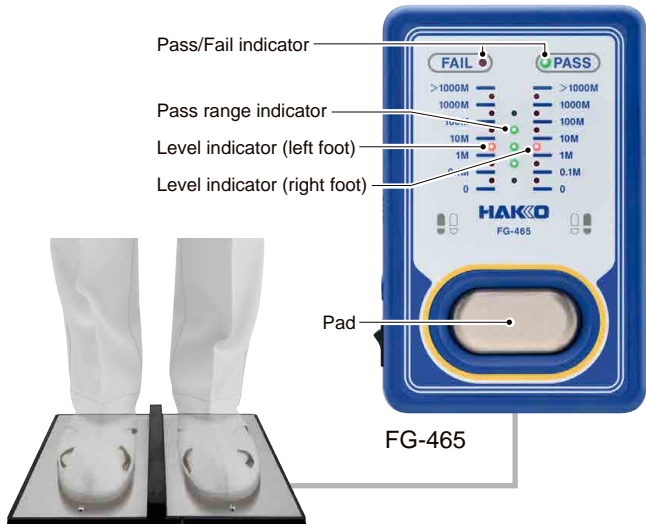

### Evaluation external output

Evaluation results can be output through the external output terminal to interlock with other devices, to open a door, turn on a signal, etc.

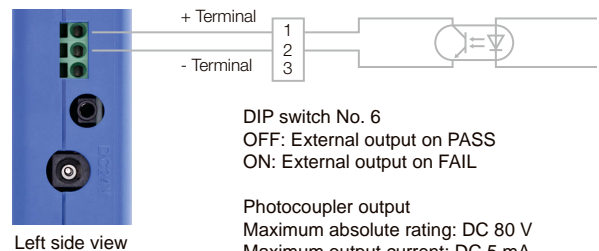

### User-friendly software

The dedicated software makes it easy to check measurement status of FG-465. The software enables digital management of all the related measurement information including operator IDs.

\*The registrations on our website are necessary to download the software.

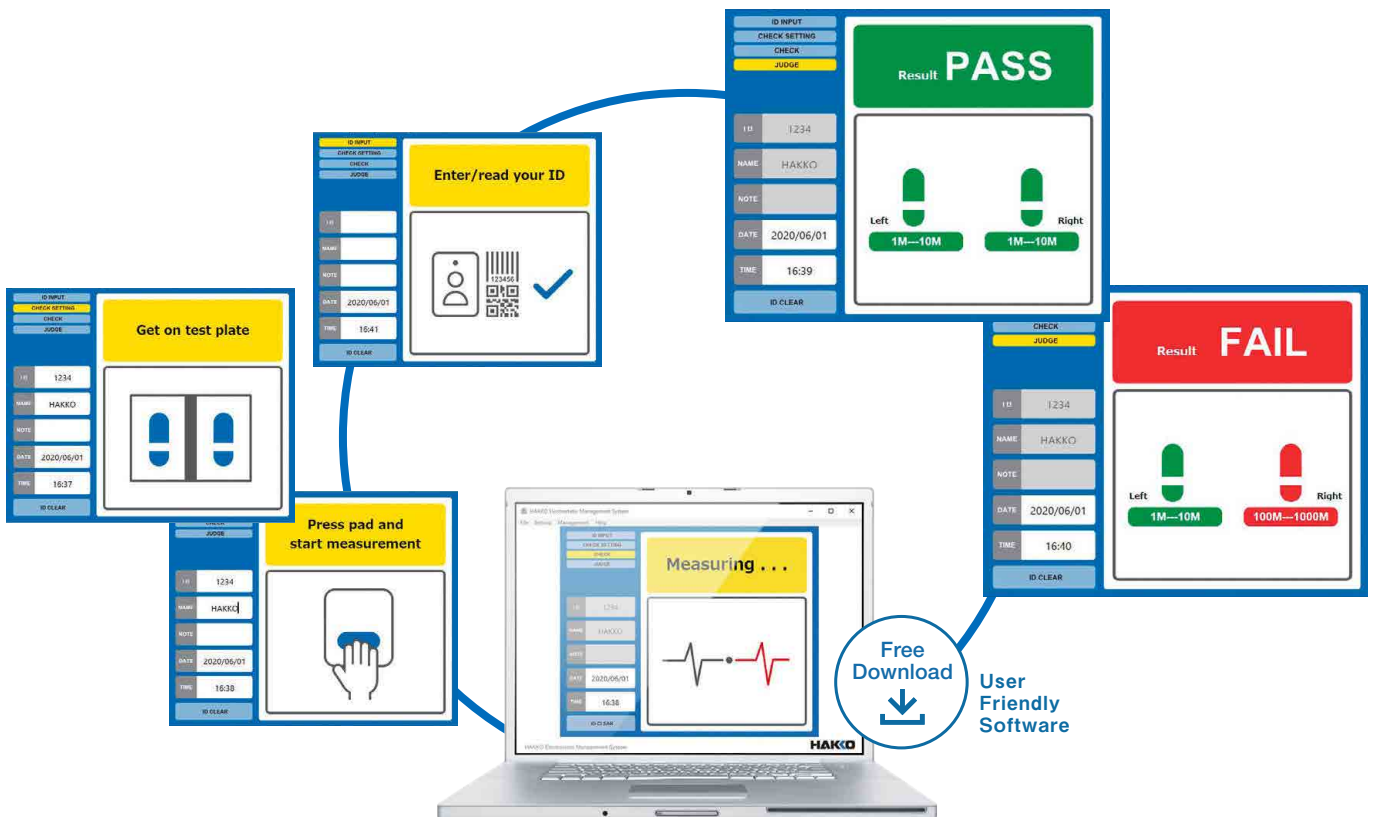

## Features

### ID Management

IDs can be input by entering numeric values, reading barcode or IC card.

Personal information can be registered in ID and operator IDs can be recorded as a part of measurement information.

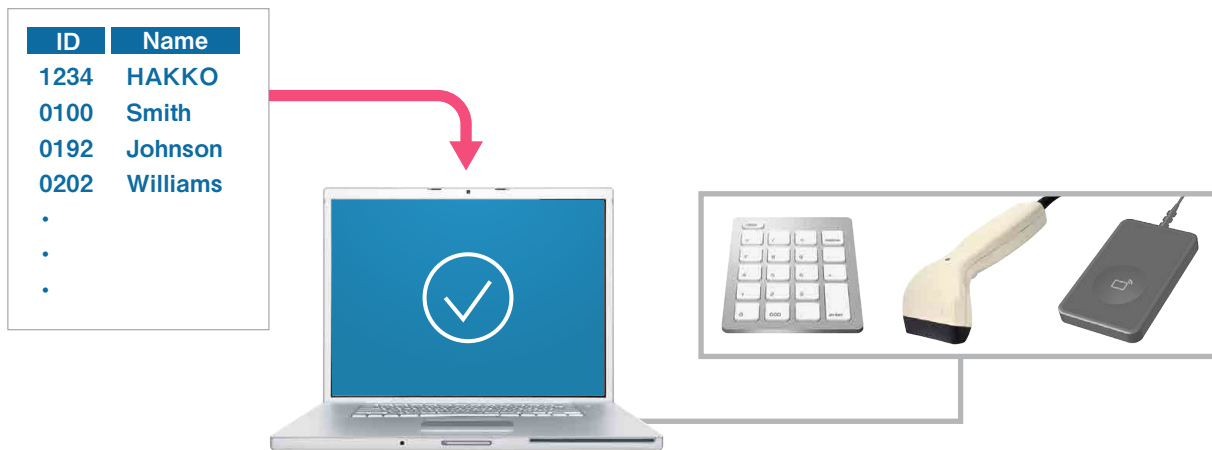

### Improved traceability

The measurement information can be automatically saved as a digital data in a specified folder. The information consists of measurement date, time, operator ID, and result of each foot to improve traceability.

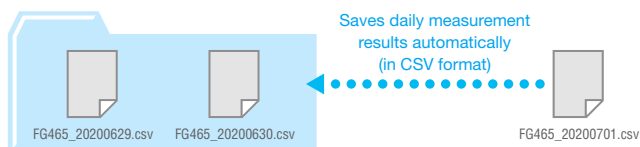

	A	B	C	D	E	F	G	H	I	J	K	L	M	N	O	P
1	Date	Time	ID	Name	Comprehe	Left foot (	Left foot (	Right foot	Right foot	Wrist strap	Conductiv	Lower eva	Upper eva	Evaluator	Evaluator	FG-470
2	2020/7/1	8:47	400	Smith	PASS	10M-100M	PASS	1M-10M	PASS	----	OFF	0.1M	100M	PASS	PASS	YES
3	2020/7/1	8:47	100	Jonson	PASS	10M-100M	PASS	10M-100M	PASS	----	OFF	0.1M	100M	PASS	PASS	YES
4	2020/7/1	8:47	192	Williams	PASS	10M-100M	PASS	10M-100M	PASS	----	OFF	0.1M	100M	PASS	PASS	YES
5	2020/7/1	8:48	202	Jones	FAIL	10M-100M	PASS	100M-100	PASS	----	OFF	0.1M	100M	PASS	PASS	YES
6	2020/7/1	8:49	410	Brown	FAIL	100M-100	FAIL	1M-10M	PASS	----	OFF	0.1M	100M	PASS	PASS	YES
7	2020/7/1	8:49	301	Davis	PASS	10M-100M	PASS	0.1M-1M	PASS	----	OFF	0.1M	100M	PASS	PASS	YES
8	2020/7/1	8:49	937	Miller	PASS	10M-100M	PASS									

### Works as a combo tester

FG-465 can work as a combo tester with FG-470, a wrist strap tester, that makes it possible to conduct measurement, evaluation and recording of both footwear and wrist strap at once.

\* Connecting cable (B5264) or Unit integration base (B5263), sold separately, is required.



## 393

### Dropper Type



- Portable, easy-to-carry manual dropper-type vacuum pick-up
- Maximum pick-up capacity of 40 gf
- Uses antistatic material

## 394

### Battery-Powered Type



- Battery-powered suction pick-up tool with built-in vacuum pump
- Maximum pick-up capacity of 120 gf
- Uses antistatic material

### Usage Example

#### HAKKO 393

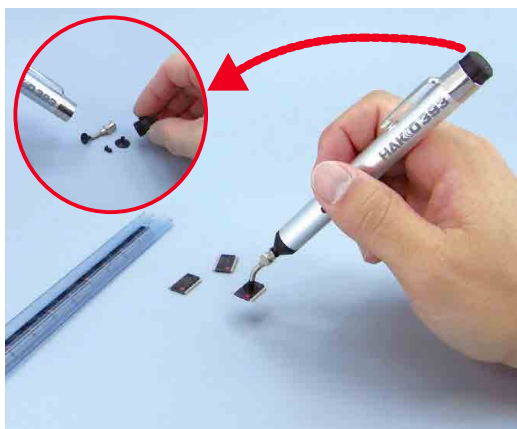

#### HAKKO 394



With the bent nozzle accessory, 0603-size components can be picked up.



### Replacement Pads and Nozzles

Part No.	Name	Specifications
A1164	Bent nozzle	0.4 mm
A1165	Bent nozzle	1.1 mm with stopper
A1198	Bent nozzle	0.26 mm
A1486	Straight nozzle	1.1 mm with stopper
A1166	Pad	3 mm
A1312	Pad	5 mm
A1167	Pad	7 mm
A1311	Pad	10 mm

### Packing List

<b>393</b>	Unit, 1.1 mm diameter bent nozzle with stopper, 3 mm diameter pad, 7 mm diameter pad, 10 mm diameter pad, Instruction manual
<b>394</b>	Unit, 1.1 mm diameter bent nozzle with stopper, 5 mm diameter pad, 10 mm diameter pad, Two AAA Alkaline batteries (for trial), Instruction manual

### Specifications

Model No.	393
Pad	Conductive silicone rubber
Dimensions	ø13 mm x 132 mm
Weight*	19 g

\* Without nozzle and pad

Model No.	394
Power supply	Two AAA batteries
Pad	Conductive silicone rubber
Battery life	Approx. 30,000 suction cycles (with alkaline batteries)
Suction capacity	120 gf (with a pad diameter of 10 mm)
Dimensions	130 (W) x 29 (H) x 22 (D) mm
Weight*	43 g

\* Without batteries, nozzle and pad

## FT-802 ESD SAFE

### Thermal Wire Stripper

Blade not included



- Thermal wire stripper for higher quality and more preciseness

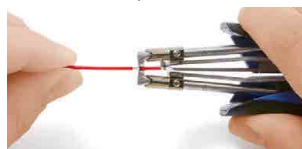

- It can strip insulation with no nick.
- Even very fine AWG 38 can be stripped with standard blades.
- Space saving by the integration of station and holder



#### Connectable with handpiece for knife type blade

Knife type blade can strip the insulation of big cable with no nick.

## FT-8003 ESD SAFE

### Handpiece for knife type blade

Blade included



### Specifications

Model No.	FT-802
Power consumption	76 W

#### Station

Output voltage	AC 20 V
Dimensions	76 (W) × 159 (H) × 161 (D) mm
Weight	1.6 kg

#### Handpiece

Power consumption	72 W (20 V)
Cord length	1.6 m
Total length*	153 mm
Weight*	47 g

\* Without cord and blade

Model No.	FT-8003
Power consumption	46 W (24 V)
Tip to ground resistance	<2 Ω
Tip to ground potential	<2 mV
Cord length	1.3 m
Total length*	155 mm
Weight*	27 g

\* Without cord and blade

### Packing List

FT-802	Station (with wire material indicator seal), Handpiece with lead adjuster (FT-8004), Hexagon socket set screw (M2.5 × 2.5 [qty 2]), Hexagon wrench (1.27 mm), Power cord, Instruction manual
FT-8003 (Conversion kit)	Handpiece (FT-8003), Knife blade, Handpiece holder, Blade removal tool, Connecting cable, Instruction manual

## Features

**Thermal strip gives great sharpness.**

**FT-802**



FT-802 can strip the insulation of AWG 38 wire with no nick.

Conventional wire stripper

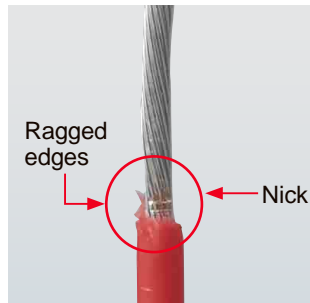

Conventional wire stripper could make ragged edges of insulation or damage strands.

**Due to the tweezers structure, the cutting edges are always aligned.**

The blades can be securely fixed by making the frame with tweezers structure.

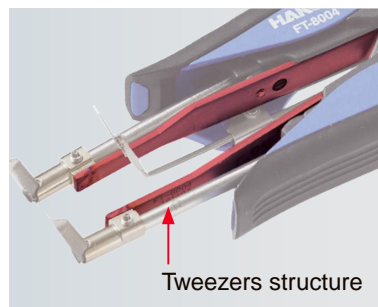

**Output setting by the unit of 5%**

**Easy to set optimum output level as per material**



Material	Output value (%)
PVC	10
PE	10
PA	20
PVDF	30
ETFE	40
SI	45
PTFE	55

\* The above values are for reference.

**Blades are replaceable and a handpiece can be saved.**

No need to replace a handpiece when blades get worn out. Blades can be easily replaced by using the hex-wrench (included in the unit) and the blade removal plate.

\* The blades must be cool before replacement for safety.



Remove blades.

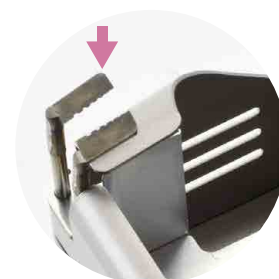

Put removed blades in the holder.

**User-friendly display**

Status of a handpiece at glance on the display.

User-friendly design for reduction of stress during the work.



- A handpiece is correctly set in a holder.
- Same as the output value.
- Ready to work immediately.
- Auto sleep function will activate after passing the set time.

## Optional Blades

**For FT-8004**

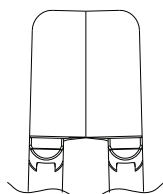

G4-1601

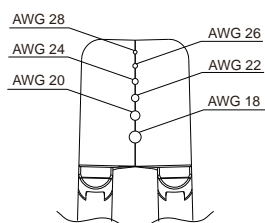

G4-1602

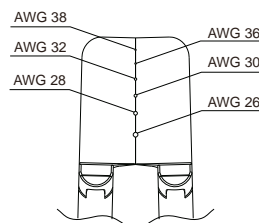

G4-1603

**For FT-8003 (option)**

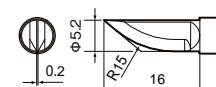

G3-1601

## 153 / 154

### Lead Cutter and Former



- Lead cutter and former for axial components
- Can be used for forming and cutting, forming only, or cutting only

#### Cutting and Forming

HAKKO 153	HAKKO 154
<p>Cutting and forming</p>	<p>Cutting and forming</p>
<p>Forming</p>	<p>Forming</p>
<p>Cutting</p>	<p>Cutting</p>

#### Packing List

153, 154	Unit, Parts tray, Clamp, Handle, 2 mm Hexagon wrench, 2.5 mm Hexagon wrench, 3 mm Hexagon wrench, 4 mm Hexagon wrench, Instruction manual
----------	---

#### Specifications

Part No.	153-1	154-1
Forming size	5.6 mm pitch	5 mm pitch
Diameter of lead wire	ø0.8 mm (max.)	ø0.5 mm (max.)
Lead wire*	For annealed copper lead wire only	
Outer width of tape	85 mm (max.)	
Taping pitch	5 mm	
Dimensions	125 (W) × 130 (H) × 110 (D) mm	
Weight**	2 kg	

\* These tools are not suited to work on components with lead frames (square lead).  
\*\* Including handle and clamp

## 155

### Lead Cutter



- Lead cutter for radial components

#### Packing List

155	Unit, Parts tray, Clamp, Handle, 2 mm Hexagon wrench, 2.5 mm Hexagon wrench, 3 mm Hexagon wrench, 4 mm Hexagon wrench, Instruction manual
-----	---

#### Specifications

Part No.	155-1	155-2
Diameter of lead wire	ø0.8 mm (max.)	
Lead wire*	For annealed copper lead wire only	
Processing part size	ø12.5 × 25 mm (max.)	ø15 × 25 mm (max.)
Feed hole pitch	12.7 mm	15 mm
Lead pitch**	5 mm, 2.5 mm	5 mm
Processing size	1.5 mm from taping end, 2 mm from component end (min.)	
Dimensions	110 (W) × 140(H) × 125 (D) mm	
Weight***	1.7 kg	

\* These tools are not suited to work on components with lead frames (square lead).  
\*\* When shipped, the unit is set for components with a lead pitch of 5 mm.  
\*\*\* Including handle and clamp

#### Cutting

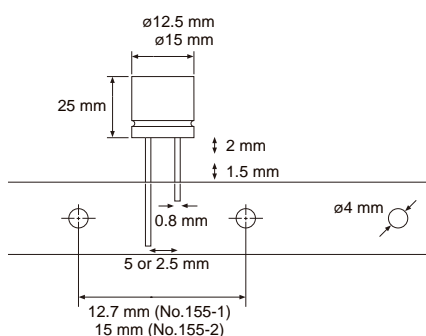

\* Cutting only



# DIPLINER

## Lead Straightener



- IC lead liner for correcting variable lead pitches
- Simple mechanism enables the adjustments with just one screw.
- Simply insert the IC case into the chute.

### Packing List

FT100, FT150, FT200, FT300	Unit, Instruction manual
----------------------------	--------------------------

### Specifications

Part No.	FT100	FT150	FT200	FT300
Width of IC	7.5 mm	10 mm	15 mm	19 mm
Number of IC leads	8, 14, 16 18, 20	22	24, 28 40, 42	64

## HAND TOOLS

### Cutting pliers, pliers and tweezers



- Pliers are recommended to cut or process annealed copper wires for electronic parts and excellent sharpness and durability due to our unique heat-treatment
- Non-magnetic stainless-steel tweezers for electronic parts

Full flush cut to make cut surface extremely flat

#### Micro cutting pliers

Narrow cutting blades for tight spaces

#### Cutting pliers

Excellent wearing resistance and durability

#### Long needle nose pliers

Needle nose eases a work in tight spaces

#### Pliers

Great usability  
Perfect to grasp and bend

Wires can be cut even at the lowest position of blades near to the joint.



General product



FT-600



FT-601



FT-620



FT-621



#### Specifications

Part No.	FT600-81			FT601-81		
Cutting capacity	ø1.2mm (max.)			ø1.5mm (max.)		
Dimensions (mm)	A	B	C	A	B	C
	117	50	11	117	51	15.5
	D	E	F	D	E	F
	6	21	13.4	8.5	24	16.8

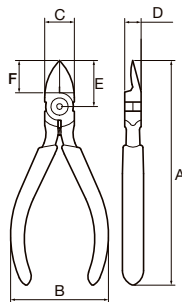

#### Specifications

Part No.	FT620-81			FT621-81		
Dimensions (mm)	A	B	C	A	B	C
	148	50	11	124	50	11
	D	E	F	D	E	F
	6	60	52.4	6	36	28.4

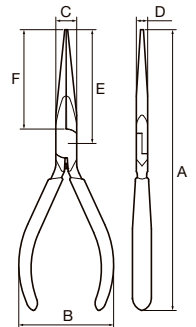

#### Precision tweezers / straight

#### Precision tweezers / bent



FT-640



FT-641

#### Specifications

Part No.	FT640-81		FT641-81	
Dimensions (mm)	A	B	A	B
	113	9	118	10



# 106

## Cutting pliers, pliers



- Wire cutters/needle-nose pliers designed for general-purpose work
- Use in cutting copper and soft lead wires (do not use on hard drawn steel wires.)

MAX.Cu = Max. annealed copper lead wire cutting capability

Cutting tool for flush cut with safety clip

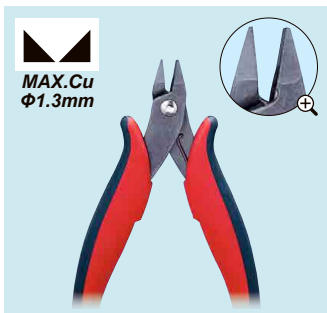

Part No. 106-01

Cutting tool for flush cut with angled blade



Part No. 106-02

Cutting tool for flush cut with small blade



Part No. 106-03

Cutting tool for a front, flush cut



Part No. 106-04

Unit : mm

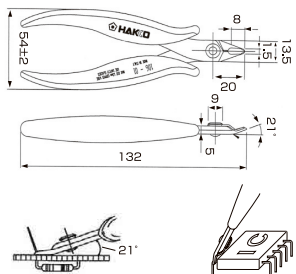

Unit : mm

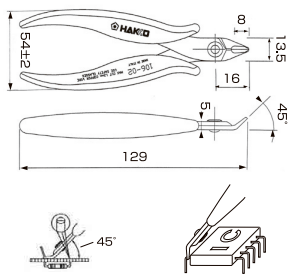

Unit : mm

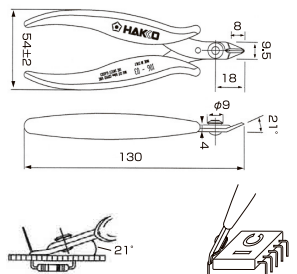

Unit : mm

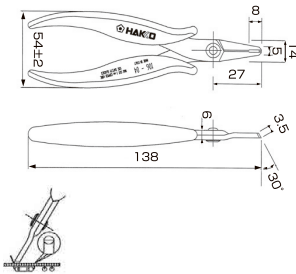

Cutting tool for flush cut



Part No. 106-05

Short nose pliers

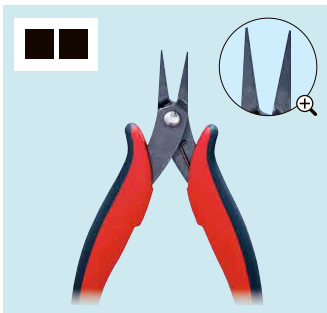

Part No. 106-06

Long nose pliers



Part No. 106-07

Bent nose pliers

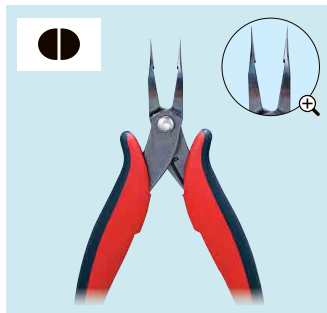

Part No. 106-08

Unit : mm

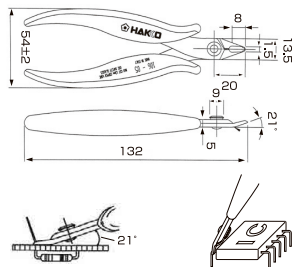

Unit : mm

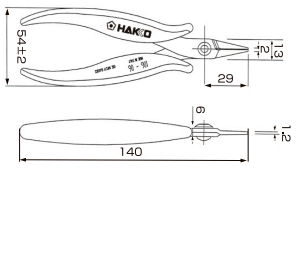

Unit : mm

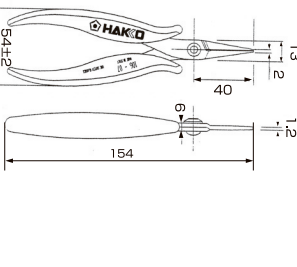

Unit : mm

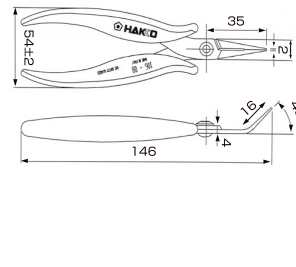

## FV-310

### Heating Gun



- Stepless control on temperature and airflow for optimal settings
- Easy replacement of heating element
- Temperature range: 80 to 530°C
- Airflow range: 0.15 m<sup>3</sup>/min.

#### Packing List

<b>FV-310</b>	Unit, Instruction manual
---------------	--------------------------



Provided in a carrying case

#### Specifications

Power Consumption	1000 W
Maximum Temperature*	530°C (80 to 530°C continuously variable)
Air Velocity	600 m/min.
Air Flow	0.15 to 0.25 m <sup>3</sup> /min.
Dimensions**	240 (W) × 190 (H) × 70 (D) mm
Weight**	0.6 kg

\* Measured at the point 10 mm from the pipe.

\*\* Without cord

## Features

### Stepless control on temperature and airflow for optimal settings

Fine control of temperature and airflow for a variety of application contributes to improvement of work efficiency.



Temperature control knob      Airflow control knob

### Types of applications

A	Drying painting and putty
B	Peeling sticker
C	Shrinking
D	Heat shrink tubing
E	Curving plastic material

### Temperature distribution chart

\* The temperature and airflow volume are reference values; these values are not guaranteed.

Airflow control knob (AIR)	Temperature control knob (TEMP.)				
	1	2	3	4	5
1 (0.15 m <sup>3</sup> /min.)	120 °C	175 °C	295 °C	425 °C	530 °C
2 (0.17 m <sup>3</sup> /min.)	110 °C	165 °C	270 °C	390 °C	505 °C
3 (0.2 m <sup>3</sup> /min.)	100 °C	145 °C	230 °C	320 °C	425 °C
4 (0.23 m <sup>3</sup> /min.)	90 °C	130 °C	205 °C	285 °C	380 °C
5 (0.25 m <sup>3</sup> /min.)	85 °C	115 °C	190 °C	270 °C	345 °C

### Easy replacement of heating element

It requires only a screwdriver to remove pipe and replace heating element.

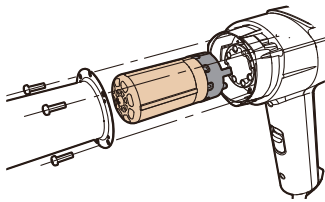

### Safety design for fall-prevention during hands-free operation

Anti-slip rubbers on the back improve stability and safety during hands-free operation.



Use of stand, an option part, secures stability for hands-free application.



Stand No.B5166

## Option

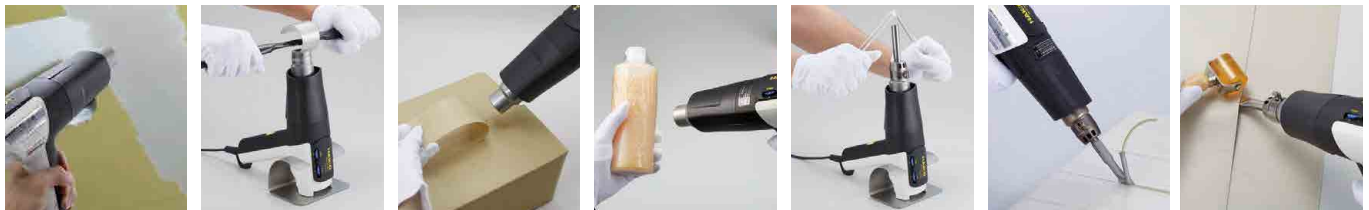

Drying, painting and putty

Heat shrink tubing  
Use of hook type nozzle and stand

Peeling sticker

Shrinking

Curving plastic material  
Use of nozzle holder and single nozzle

Welding floor coverings  
Use of nozzle holder and V type nozzle

Welding PVC sheet  
Use of nozzle holder and spatula type nozzle along with roller

**Spatula type nozzle 20 mm**  
No.N70-01



**Spatula type nozzle 62 mm**  
No.N70-02



**Hook type nozzle 20 mm**  
No.N70-03



**Hook type nozzle 40 mm**  
No.N70-04



\* Use this nozzle on the nozzle holder (N70-05).

**Nozzle holder**  
No.N70-05



**Single nozzle 12 mm**  
No.N70-06



\* Use this nozzle on the nozzle holder (N70-05).

**V type nozzle for 4 mm welding rod**  
No.N70-07



\* Use this nozzle on the nozzle holder (N70-05).

**Roller**  
No.A1115



## Topic Failure-Free Heat-Shrinking of Waterproof tube

By using FV-310 Heating Gun and an optional nozzle, everyone can quickly, beautifully and equally, shrink waterproof heat-shrink tube, which is difficult work.

Using the optional nozzle shown below, the hot air from the nozzle flows along the hook-shaped baffle, so that the entire section of heat-shrink tube is shrunk quickly.



Hook type nozzle  
20 mm, 45 mm I.D  
No. N70-03



FV-310  
See P. 98



For further details,  
please scan here.

### Temperature distribution chart

\* The temperature and airflow volume are reference values; these values are not guaranteed.

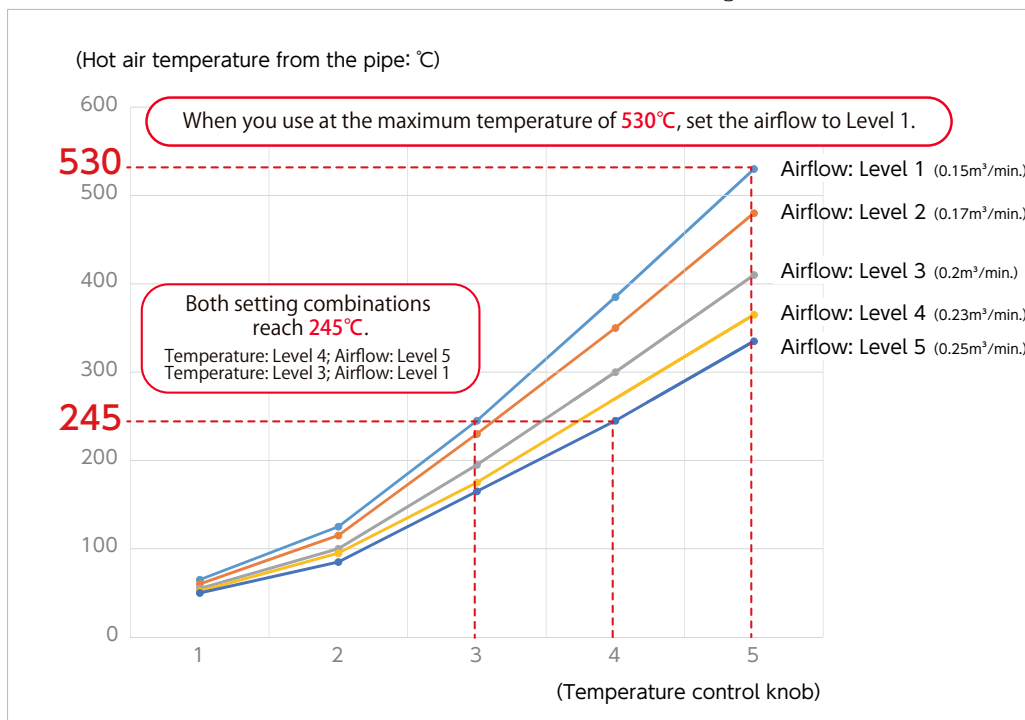

Although there is a click feeling, adjustment is stepless. Temperature and airflow suitable for the work can be set.



**HEAD OFFICE**

4-5, SHIOKUSA 2-CHOME, NANIWA-KU, OSAKA, 556-0024 JAPAN  
TEL: +81-6-6561-3225 FAX: +81-6-6561-8466  
<https://www.hakko.com> E-mail: [sales@hakko.com](mailto:sales@hakko.com)

**Please access the web address below for other distributors.**

**<https://www.hakko.com>**



**QMS.EMS**

**ISO 9001**

**ISO 14001**

**JSAQ181, JSAE601**

Production Section only is certified by ISO 9001.



**JAB**

**CM001**