

## Product information

# 20 05 140

- Flat, short, wide jaws
- Knurled gripping surfaces
- Special tool steel, forged, oil-hardened

## Flat Nose Pliers

DIN ISO 5745



### General

Article No.	20 05 140
EAN	4003773042464
Pliers	chrome-plated
Head	chrome-plated
Handles	with multi-component grips
Weight	136 g
Dimensions	140 x 56 x 18 mm
Standard	DIN ISO 5745
REACH compliant	does not contain SVHC
RoHS compliant	not applicable

### Technical details

Jaw thickness (joint) (T1)	9.5 mm
Jaw length (L3)	28.0 mm
Head width (W3)	15.5 mm

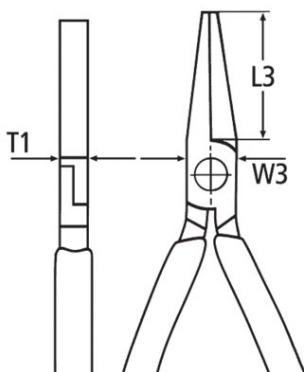

*technical change and errors excepted*

