

## SPECIFICATION

- Part No. : **CGGBP.35.6.A.02**
- Product Name : 35mm\*35mm\*6.5mm 3~4dBi  
GPS/GLONASS/GALILEO/BEIDOU  
Embedded Patch Antenna  
BEIDOU 1561MHz / GPS-GALILEO 1575MHz /  
GLONASS 1602MHz
- Feature : Dielectric Ceramic  
Pin Mount  
RoHS Compliant



## 1. Introduction

This 35mm square ceramic GPS/GLONASS/GALILEO/BEIDOU patch antenna's wide band of operation leads to excellent gain and radiation pattern stability on all three GNSS system bands.

Compared to using a smaller antenna, this will translate into the GNSS system having much higher location accuracy, improved reliability of lock in urban areas, better signal reception, with more satellites acquired and a quicker time to first fix.

The patch is mounted via pin and double-sided adhesive.

## 2. Specification

ELECTRICAL	
Frequency	BeiDou: 1561.098MHz $\pm$ 2.046MHz GPS/GALILEO: 1575.42 $\pm$ 1.023MHz GLONASS: 1602 $\pm$ 5MHz
Centre Frequency	1594MHz $\pm$ 6MHz
VSWR	1.8: 1 max
Bandwidth	80MHz Return Loss @-10dB
Peak Gain	BeiDou: +6.0dBi typ. GPS/GALILEO: +6.0dBi typ. GLONASS: +6.1dBi typ.
Impedance	50 $\Omega$
MECHANICAL	
Dimensions	35 x 35 x 6.5mm
Material	Ceramic
Pin Diameter	0.9mm
Pin Length	4.0mm
ENVIRONMENTAL	
Operation Temperature	-40°C to 85°C
Storage Temperature	-40°C to 105°C
Humidity	Non-condensing 65°C 95% RH

## 3. Antenna Characteristics

### 3.1. Test Setup

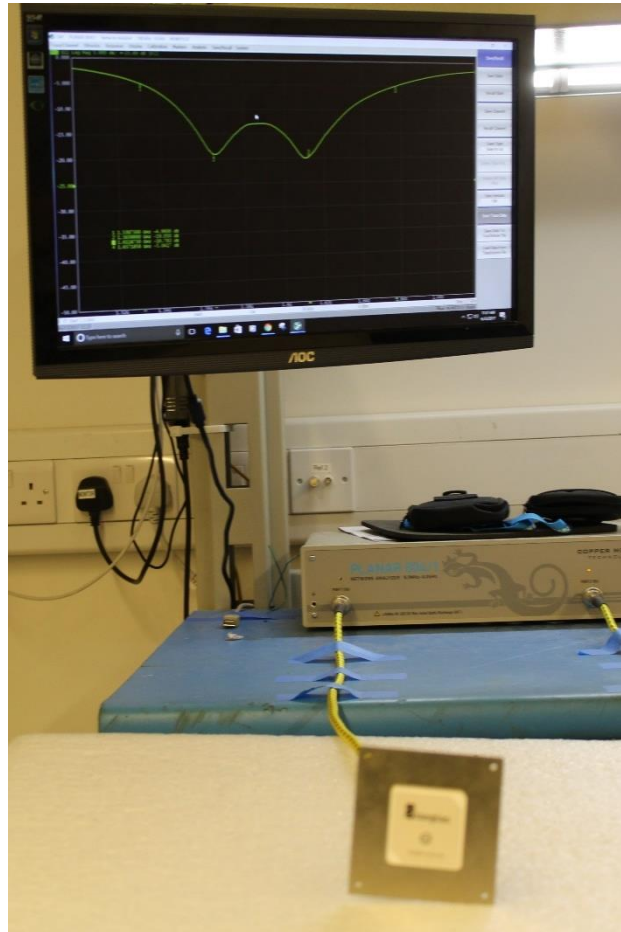

### 3.2. Return Loss

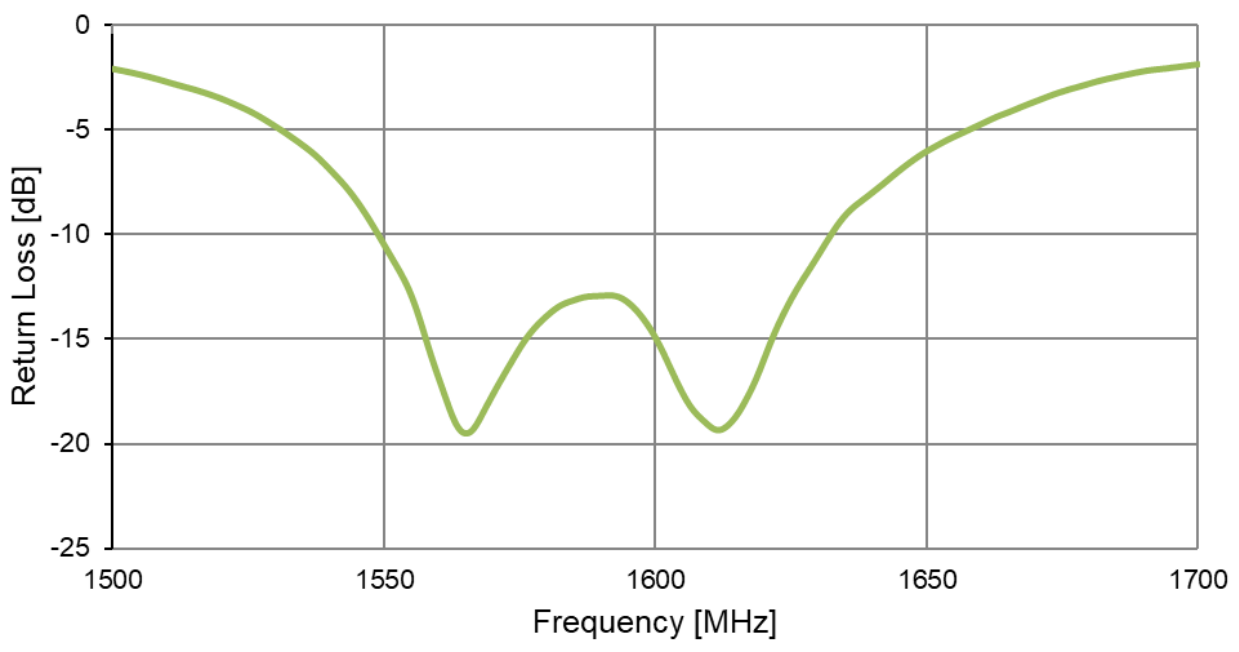

### 3.3. VSWR

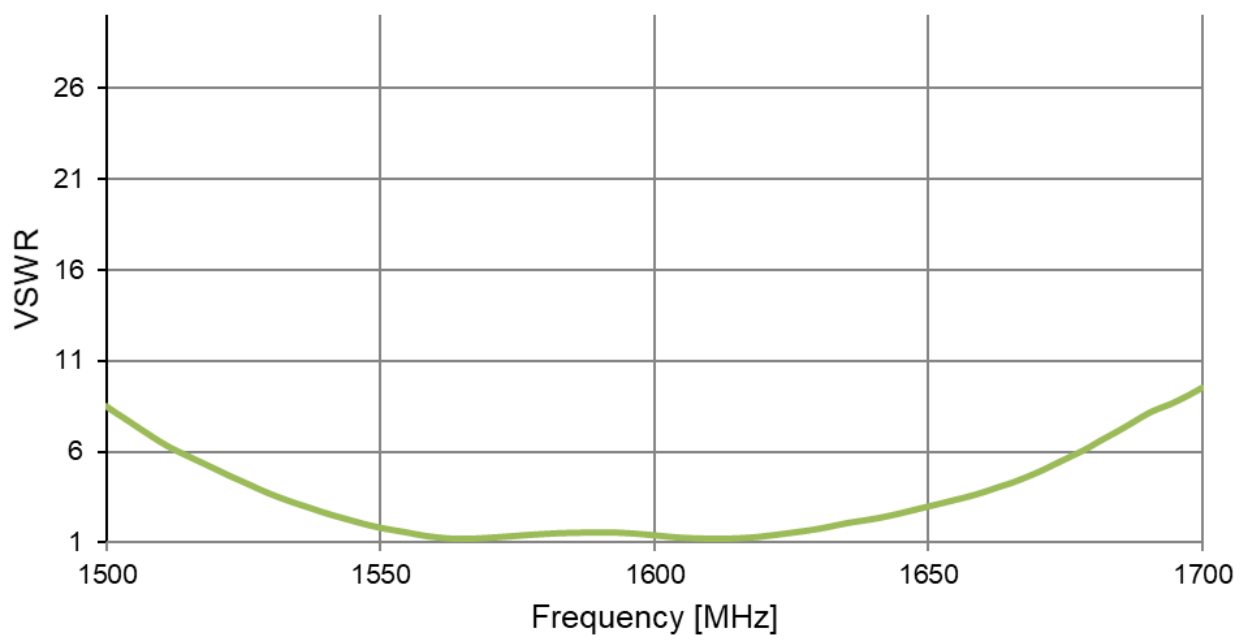

### 3.4. Efficiency

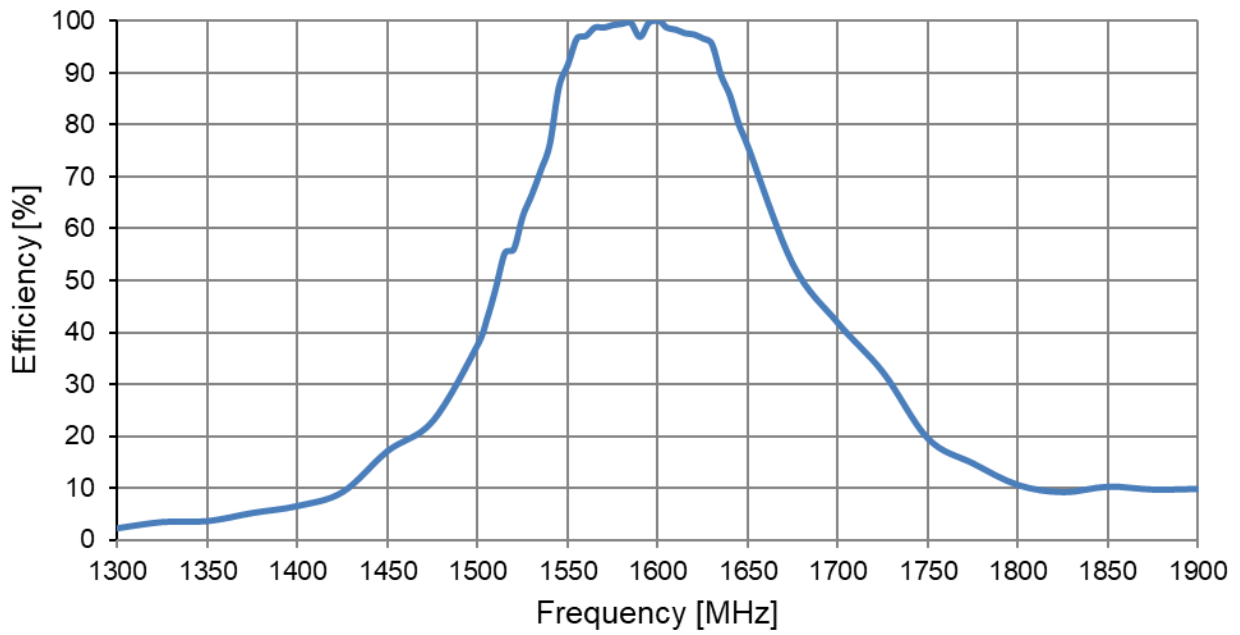

### 3.5. Peak Gain

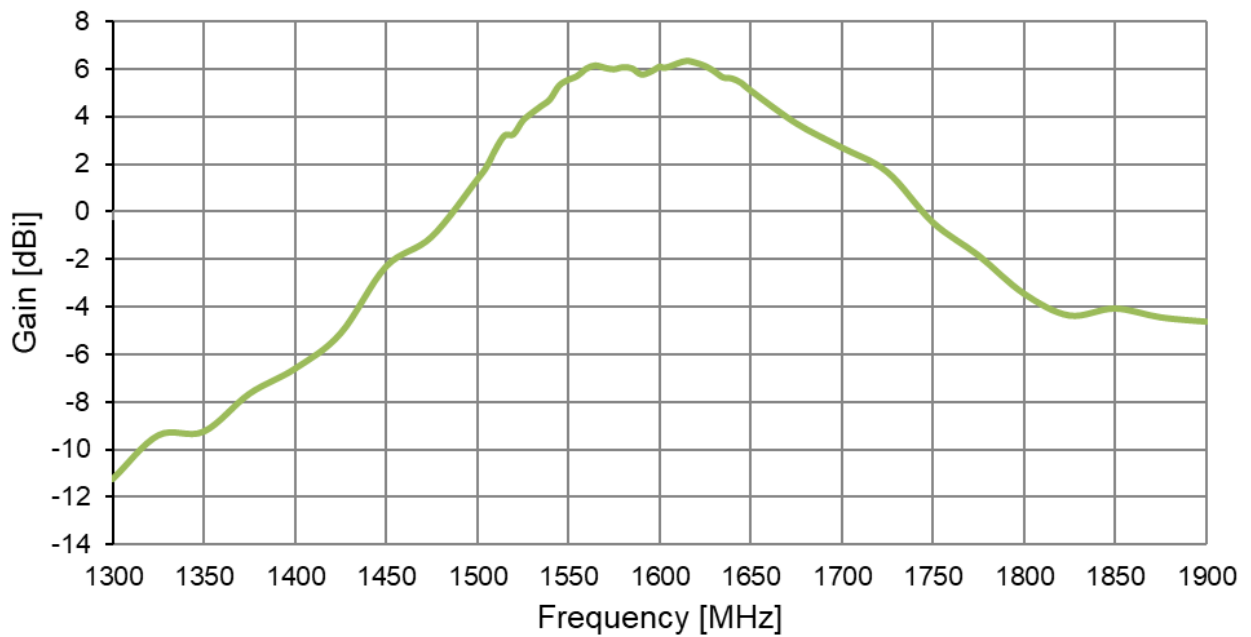

### 3.6. Average Gain

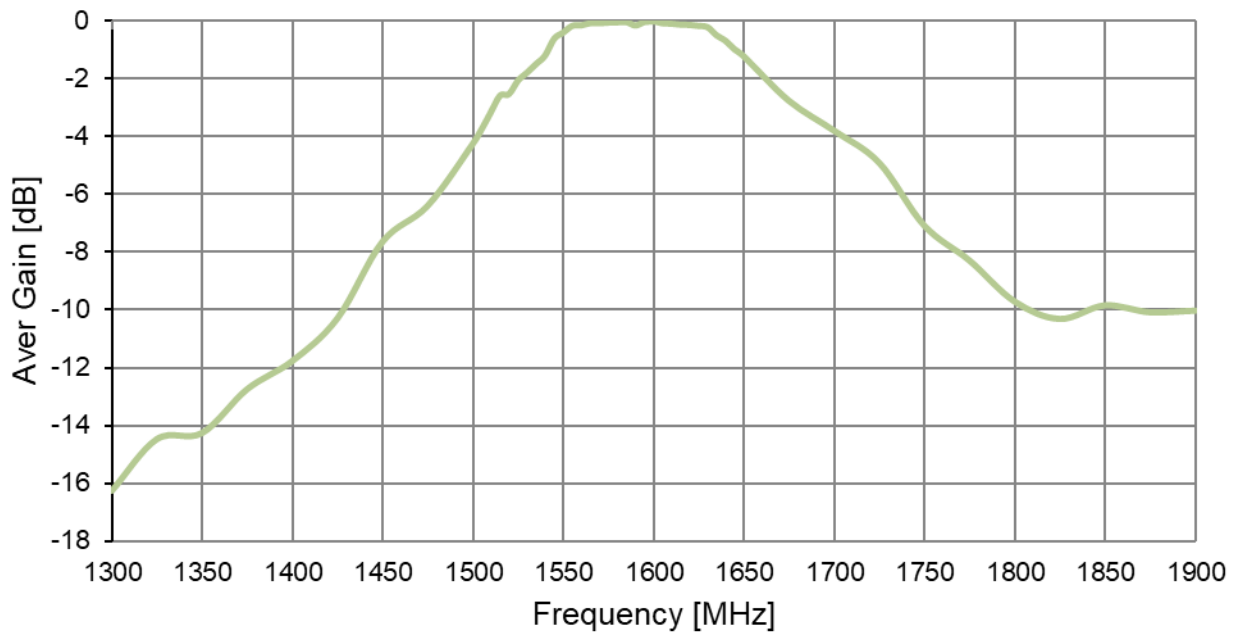

### 3.7. Axial Ratio

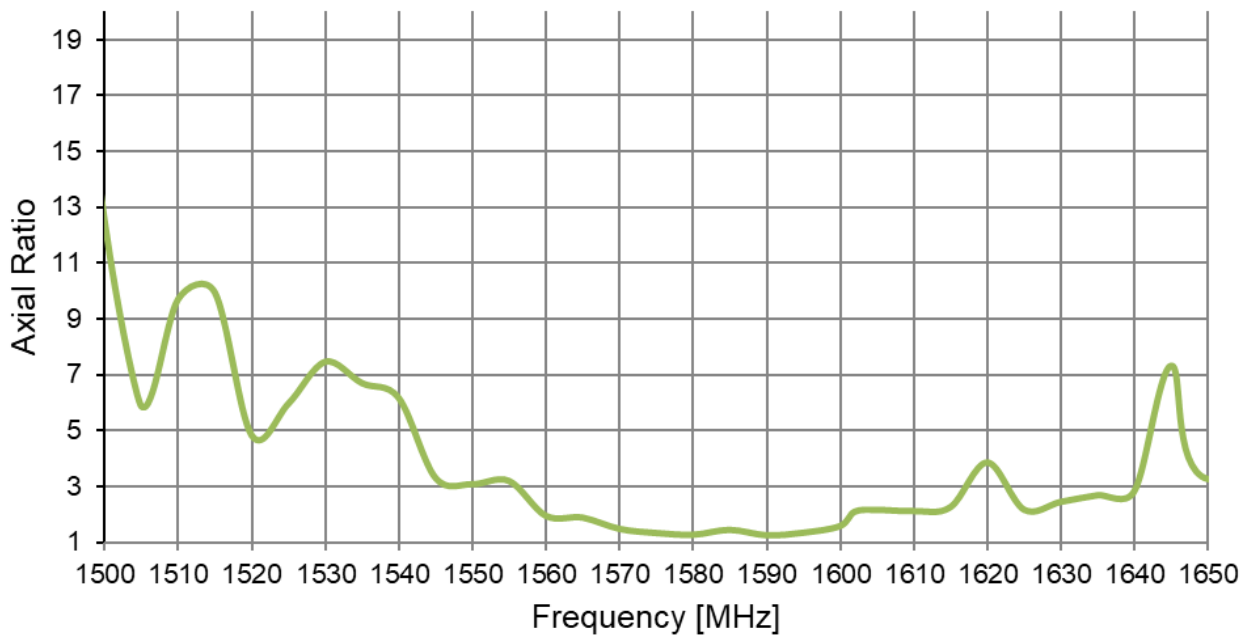

### 3.8. S11 Properties

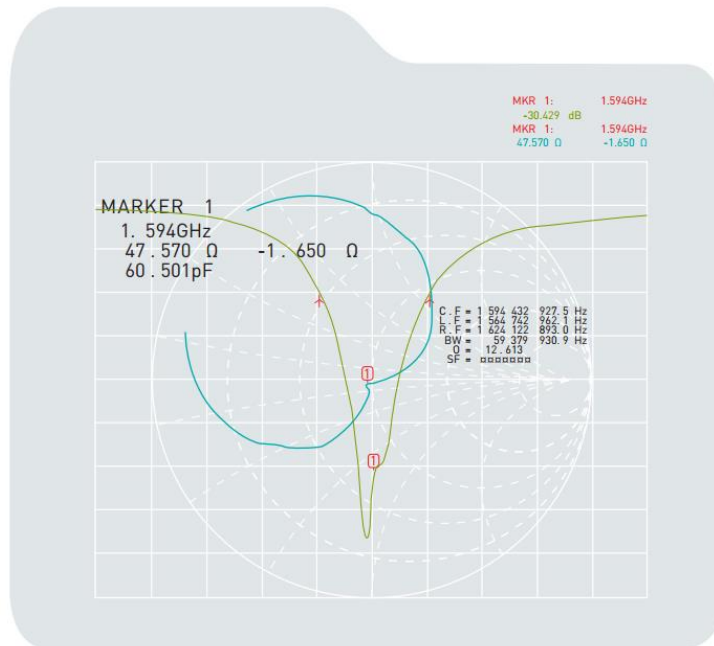



## 4. 2D Antenna Radiation

XY Plane

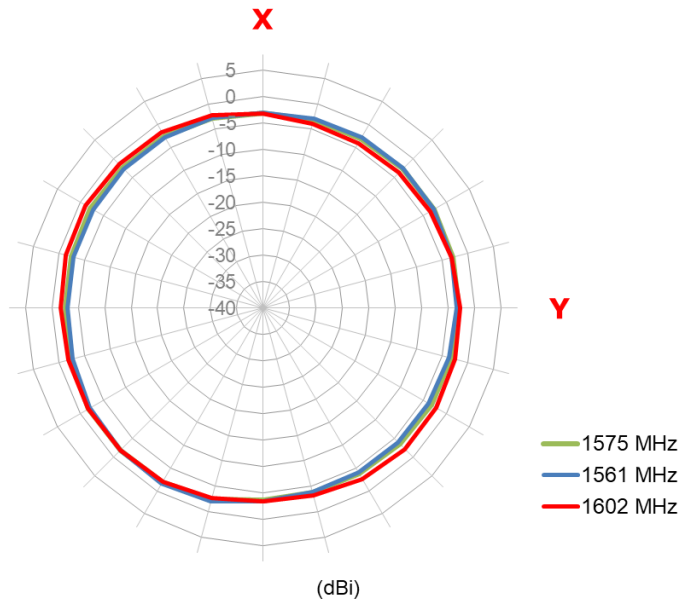

XZ Plane

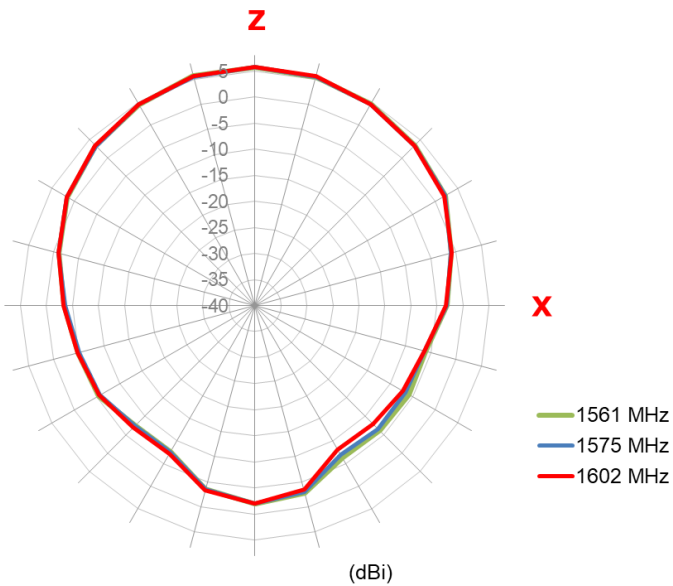

YZ Plane

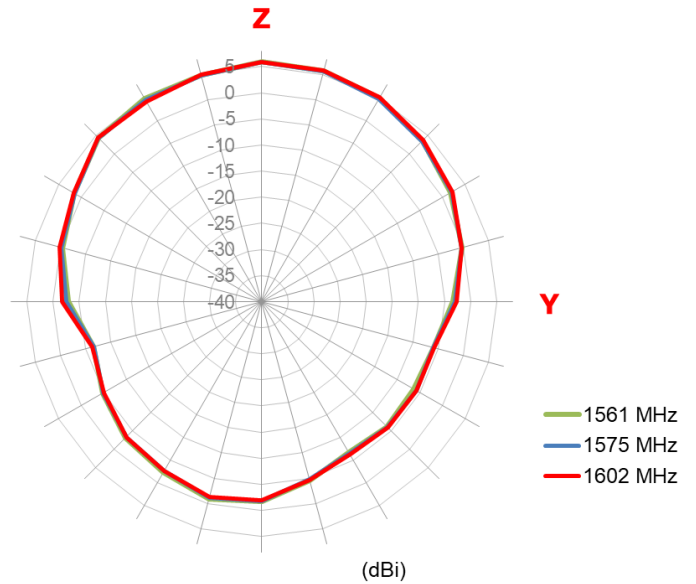

# 5. Mechanical Drawing

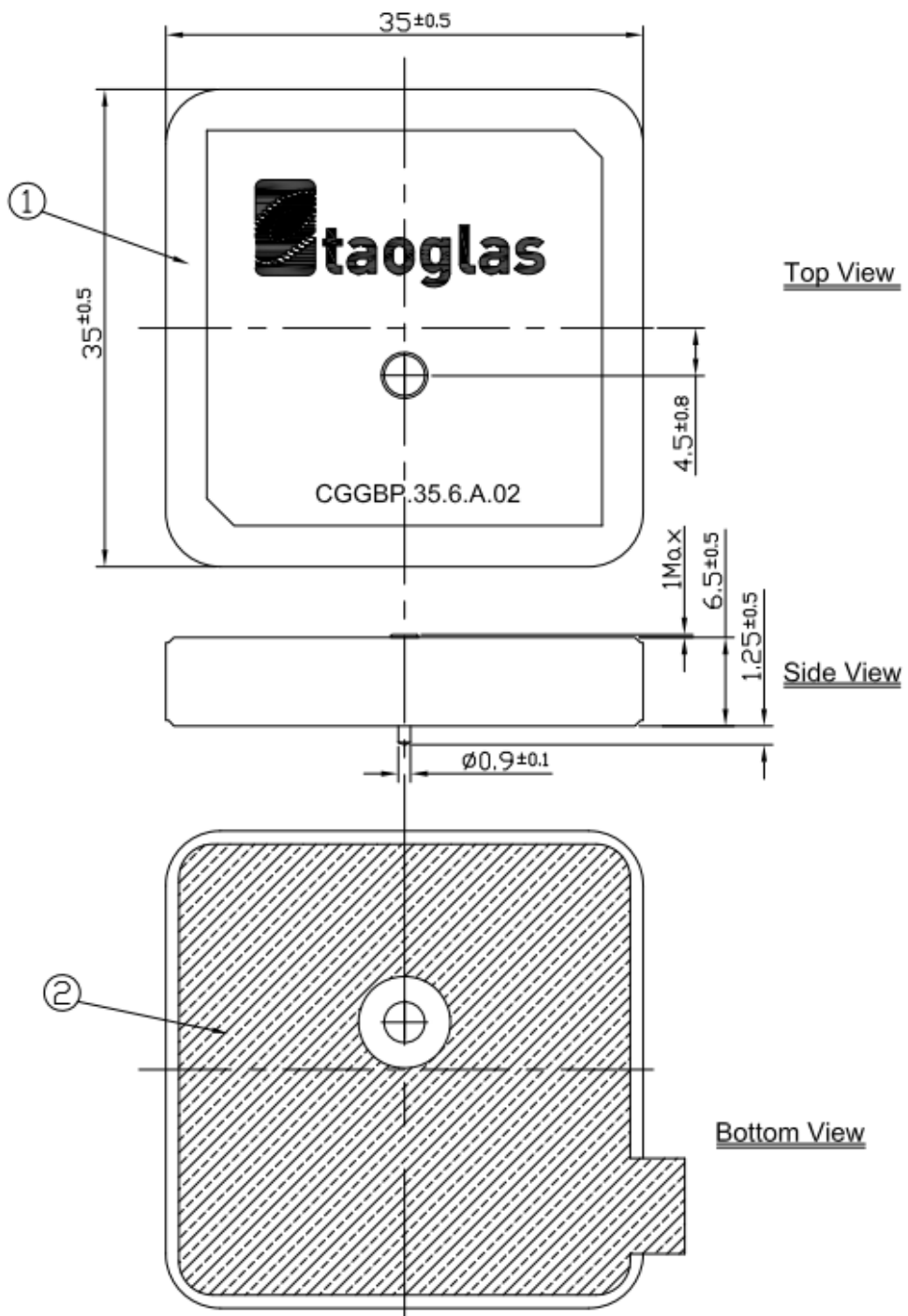

NOTES:  
 1. Double sided adhesive area 

### 5.1. Adhesive Thickness

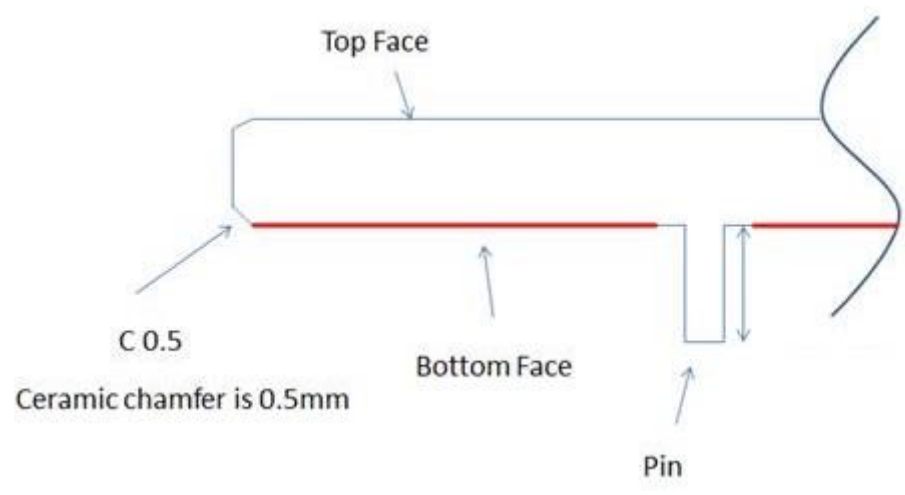

Red Line shows the adhesive without Liner – thickness 0.08~0.1mm

## 6. CGGBP.D.35.A EVB

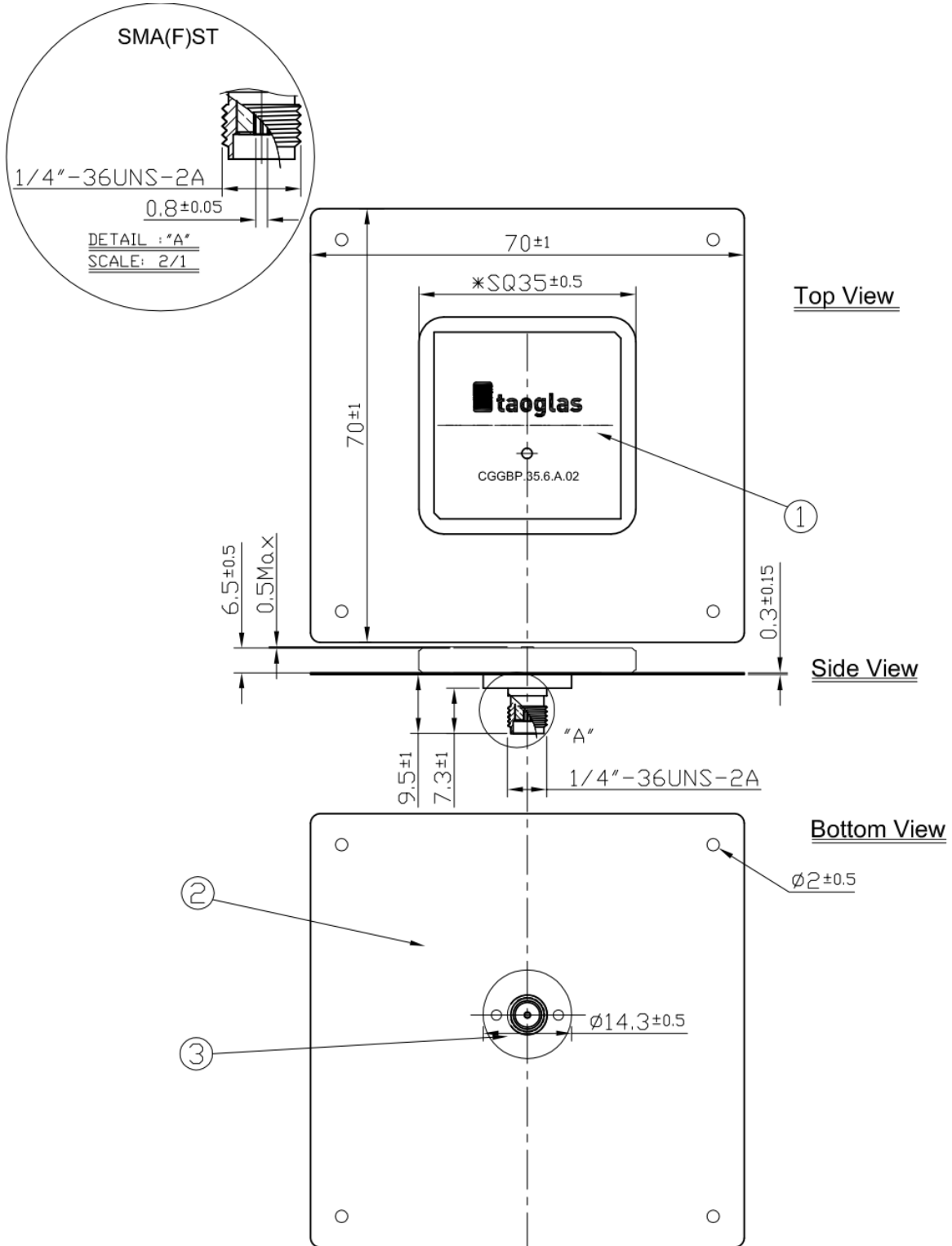



### 6.1. PCB Footprint Recommendation

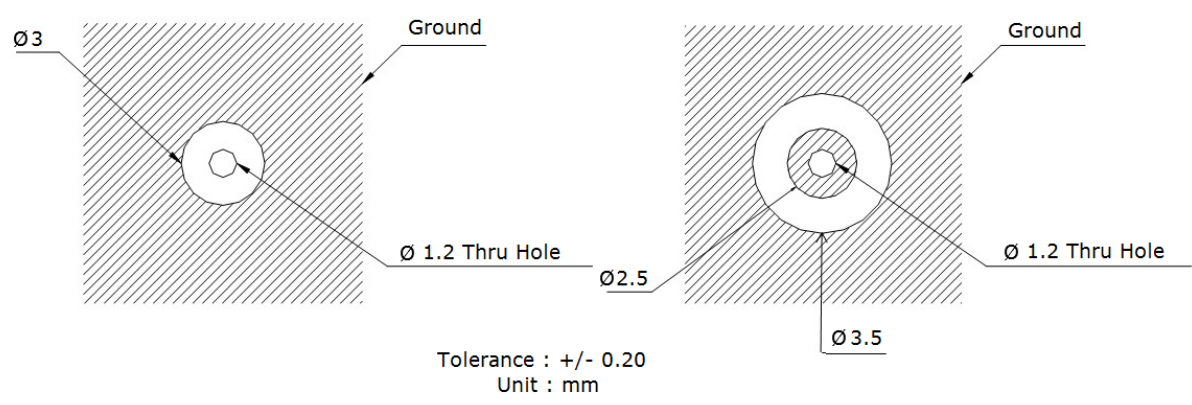

## 7. Packaging

### 7.1. Inner Tray

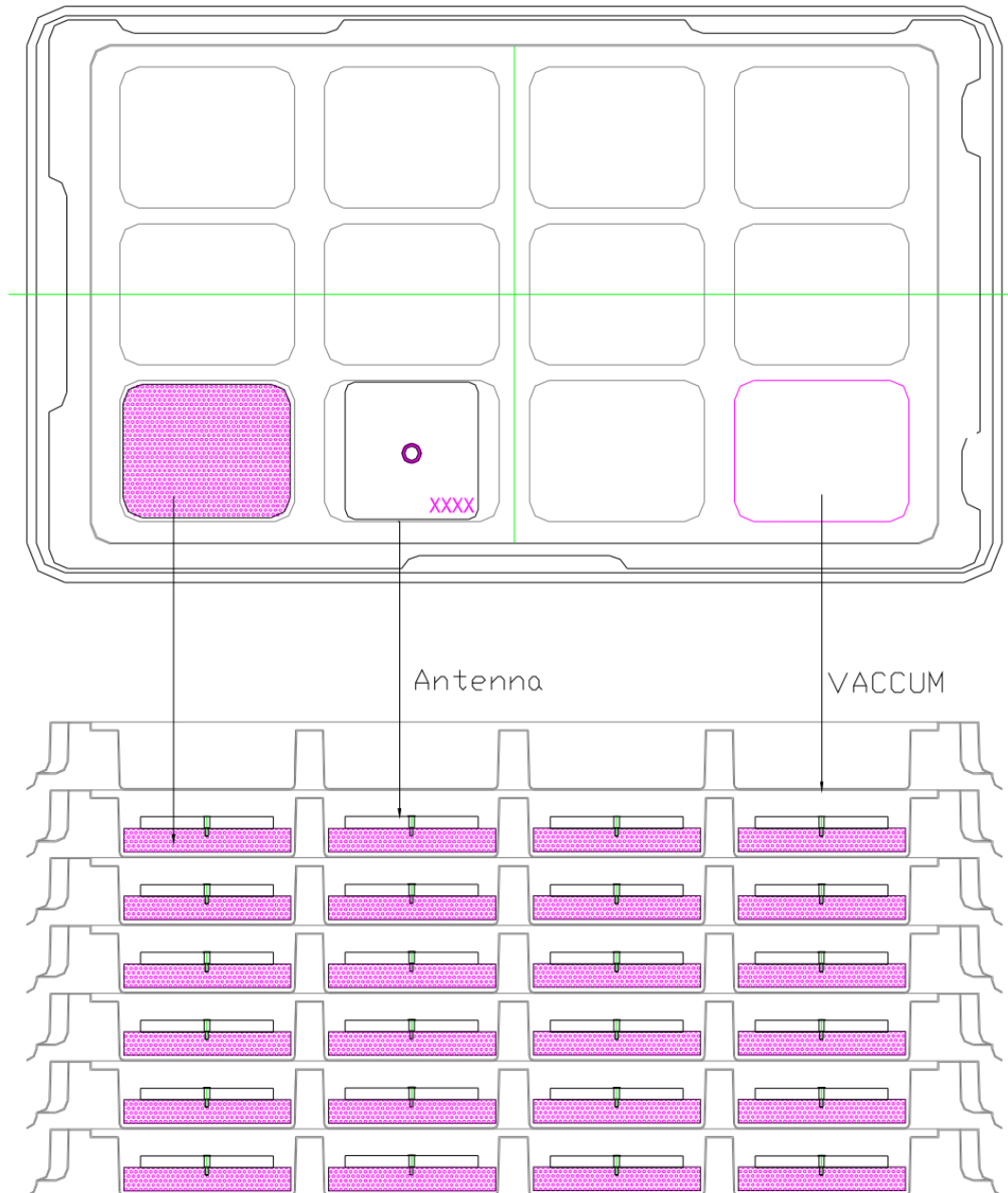

12 pieces per tray

6 Trays per Inside Box = 72

4 Inside Boxes per Outer Carton -Outer Carton contains 288 pieces

## 7.2. Carton

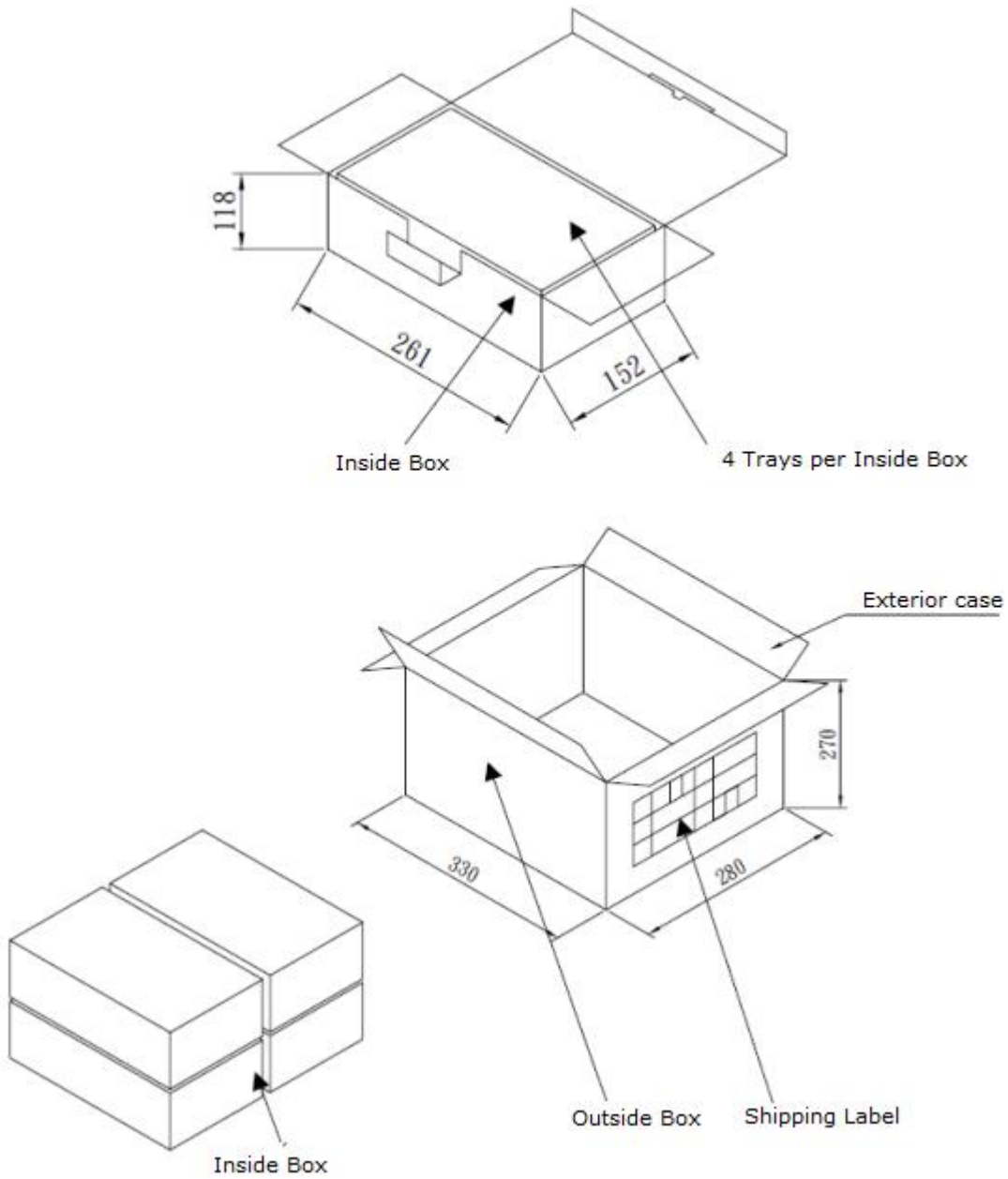

Taoglas makes no warranties based on the accuracy or completeness of the contents of this document and reserves the right to make changes to specifications and product descriptions at any time without notice. Taoglas reserves all rights to this document and the information contained herein.

Reproduction, use or disclosure to third parties without express permission is strictly prohibited.

Copyright © Taoglas Ltd.