

MCOT128064HV-YM	128 x 64	OLED Module
Specification		
Version: 1	Date: 07/11/2015	
Revision		
1	05/11/2015	First Issue

Display Features			Box Quantity	Weight / Display
Resolution	128 x 64			
Appearance	Yellow on Black			
Logic Voltage	3~5V			
Interface	Multi			
Module Size	60.50 x 37.00 x 2.00mm			
Operating Temperature	-40°C ~ +80°C			
Construction	COT			

* - For full design functionality, please use this specification in conjunction with the SSD1309 specification. (Provided Separately)

Display Accessories	
Part Number	Description

Optional Variants	
Appearance	Voltage



Functions and Features

- 128X64 Graphic
- Built-in controller
- viewing angle Free
- Wide Temperature -40°C ~ +80°C (Operating)
- RoHS compliant

Mechanical Specification

Item	Description	
Product No.	MCOT128064HV-YM	
Inch	2.42"	
Color	Yellow	
Active Area	55.01(W)×27.49(H)	mm
Panel Size	60.50(W)×37.00(H)×2.00(D)	mm
Dot Size	0.4(W)×0.4(H)	mm
Dot Pitch	0.43(W)×0.43(H)	mm
Display Format	128×64	
Duty Ratio	1/64 Duty	Duty
Controller	SSD1309 or Equivalent	
Operation Temperature	-40~80	°C
Storage Temperature	-40~85	°C
Response Time	≤10	us
Assembly	Connecter	



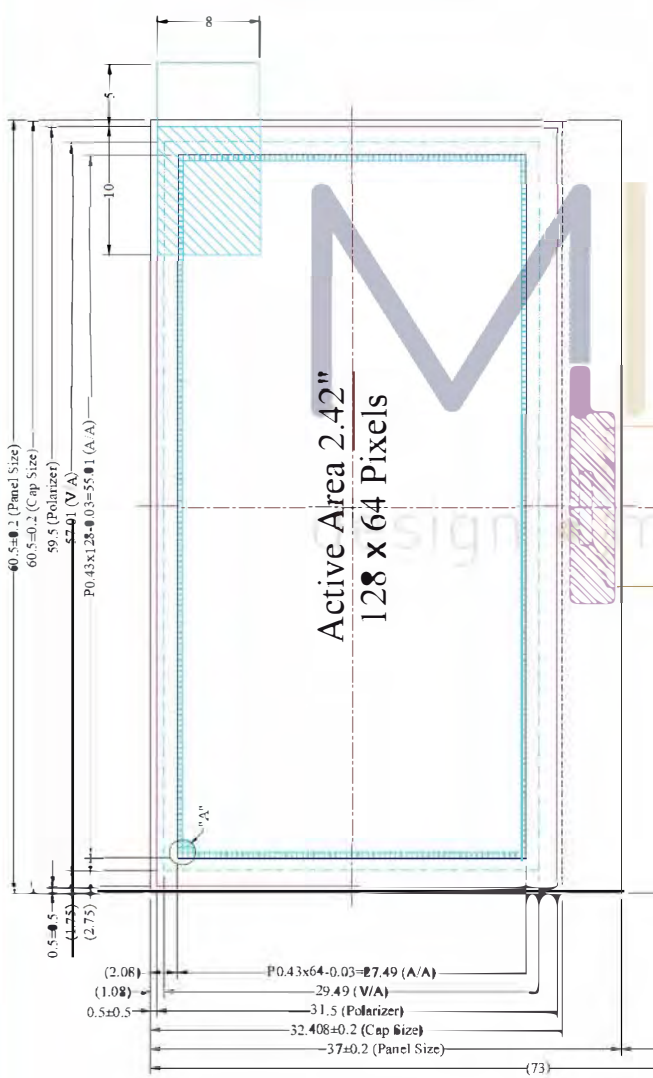
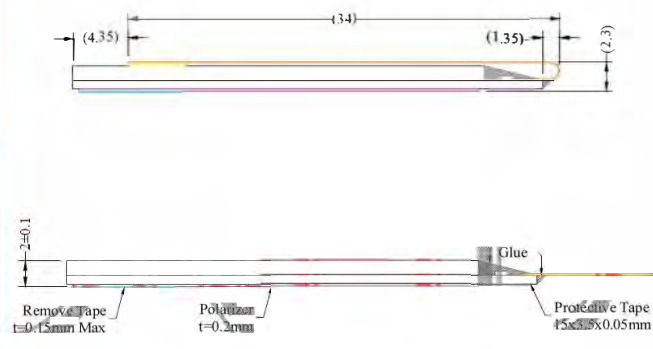

Pin	Symbol	Function
1	N.C. (GND)	
2	V _{LS}	
3	V _{SS}	
4	N.C.	
5	VDD	
6	BS1	
7	BS2	
8	CS#	
9	RES#	
10	V _{CM}	
11	R/N#	
12	ER#	
13	D0	
14	D1	
15	D2	
16	D3	
17	D4	
18	D5	
19	D6	
20	D7	
21	REF	
22	V _{CMH}	
23	VCC	
24	N.C. (GND)	

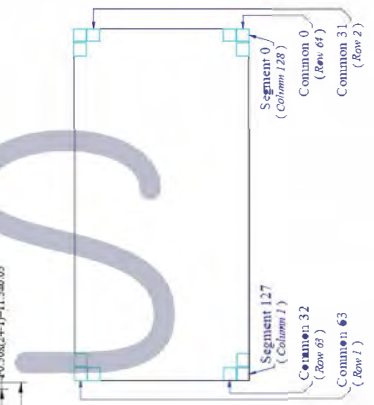
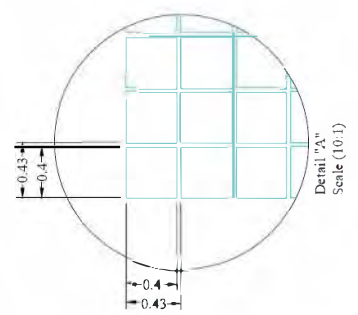

- Notes:**
1. Color: Light Blue
 2. Driver IC: SSD1309
 3. FPC Number: UT-0205-P05
 4. Interface: 8-bit 68XX/80XX Parallel, 4-wire SPI, I2C
 5. General Tolerance: ±0.3
 6. The total thickness (2.10 Max) is without polarizer, protective film & remove tape. The actual assembled total thickness with above materials should be 2.35 Max.

Pin Description

Power Supply

Pin Number	Symbol	Type	Function
5	VDD	P	Power Supply for Logic Circuit This is a voltage supply pin. It must be connected to external source.
3	VSS		Ground of Logic Circuit This is a ground pin. It also acts as a reference for the logic pins. It must be connected to external ground.
23	VCC		Power Supply for OEL Panel This is the most positive voltage supply pin of the chip. It must be supplied externally.
2	VLSS		Ground of Analog Circuit This is an analog ground pin. It should be connected to VSS externally.

Dirver

Pin Number	Symbol	Type	Function
21	IREF	I	Current reference for Brightness Adjustment This pin is segment current reference pin. A resistor should be connected between this pin and VSS. Set the current at 10 μ A maximum.
22	VCOMH	O	Voltage Output High Level for COM Signal This pin is the input pin for the voltage output high level for COM signals. A tantalum capacitor should be connected between this pin and VSS.



Interface

Pin Number	Symbol	Type	Function															
6 7	BS1 BS2		<p>Communicating Protocol Select</p> <p>These pins are MCU interface selection input. See the following table:</p> <table border="1"> <thead> <tr> <th></th> <th>BS1</th> <th>BS2</th> </tr> </thead> <tbody> <tr> <td>I2C</td> <td>1</td> <td>0</td> </tr> <tr> <td>4-wire Serial</td> <td>0</td> <td>0</td> </tr> <tr> <td>8-bit 68xx Parallel</td> <td>0</td> <td>1</td> </tr> <tr> <td>8-bit 80xx Parallel</td> <td>1</td> <td>1</td> </tr> </tbody> </table>		BS1	BS2	I2C	1	0	4-wire Serial	0	0	8-bit 68xx Parallel	0	1	8-bit 80xx Parallel	1	1
				BS1	BS2													
			I2C	1	0													
			4-wire Serial	0	0													
			8-bit 68xx Parallel	0	1													
8-bit 80xx Parallel	1	1																
9	RES#	<p>Power Reset for Controller and Driver</p> <p>This pin is reset signal input. When the pin is low, initialization of the chip is executed. Keep this pin pull high during normal operation.</p>																
8	CS#	<p>Chip Select</p> <p>This pin is the chip select input. The chip is enabled for MCU communication only when CS# is pulled low.</p>																
10	D/C#	<p>Data/Command Control</p> <p>This pin is Data/Command control pin. When the pin is pulled high, the input at D7~D0 will be interpreted as display data. When the pin is pulled low, the input at D7~D0 will be transferred to the command register.</p> <p>When the pin is pulled high and serial interface mode is selected, the data at SDIN will be interpreted as data. When it is pulled low, the data at SDIN will be transferred to the command register. In I2C mode, this pin acts as SA0 for slave address selection. For detail relationship to MCU interface signals, please refer to the Timing Characteristics Diagrams.</p>																
		<p>Read/Write Enable or Read</p> <p>This pin is MCU interface input. When interfacing to a 68XX-series microprocessor, this pin will be used as the Enable (E) signal. Read/write operation is initiated when this pin is pulled high and the CS# is pulled low. When connecting to an 80XX-microprocessor, this pin receives the Read (RD#) signal. Data read operation is initiated when this pin is pulled low and CS# is pulled low.</p> <p>When serial mode is selected, this pin must be connected to VSS.</p>																
11	R/W#	<p>Read/Write Select or Write</p> <p>This pin is MCU interface input. When interfacing to a 68XX-series microprocessor, this pin will be used as Read/Write (R/W#) selection input. Pull this pin to "High" for read mode and pull it to "Low" for write mode.</p> <p>When 80XX interface mode is selected, this pin will be the Write (WR#)</p>																



			input. Data write operation is initiated when this pin is pulled low and the CS# is pulled low. When serial or I2C mode is selected, this pin must be connected to VSS.
13~20	D0~D7	I/O	Host Data Input/Output Bus These pins are 8-bit bi-directional data bus to be connected to the microprocessor's data bus. When serial mode is selected, D1 will be the serial data input SDIN and D0 will be the serial clock input SCLK. When I2C mode is selected, D2, D1 should be tied together and serve as SDAOUT, SDAIN in application and D0 is the serial clock input, SCL. Unused pins must be connected to VSS except for D2 in serial mode.

Reserve

Pin Number	Symbol	Type	Function
4	N.C.	-	Reserved Pin The N.C. pin between function pins is reserved for compatible and flexible design.
1, 24	N.C. (GND)	-	Reserved Pin (Supporting Pin) The supporting pins can reduce the influences from stresses on the function pins. These pins must be connected to external ground as the ESD protection circuit.

DESIGN • MANUFACTURE • SUPPLY



Block Diagram

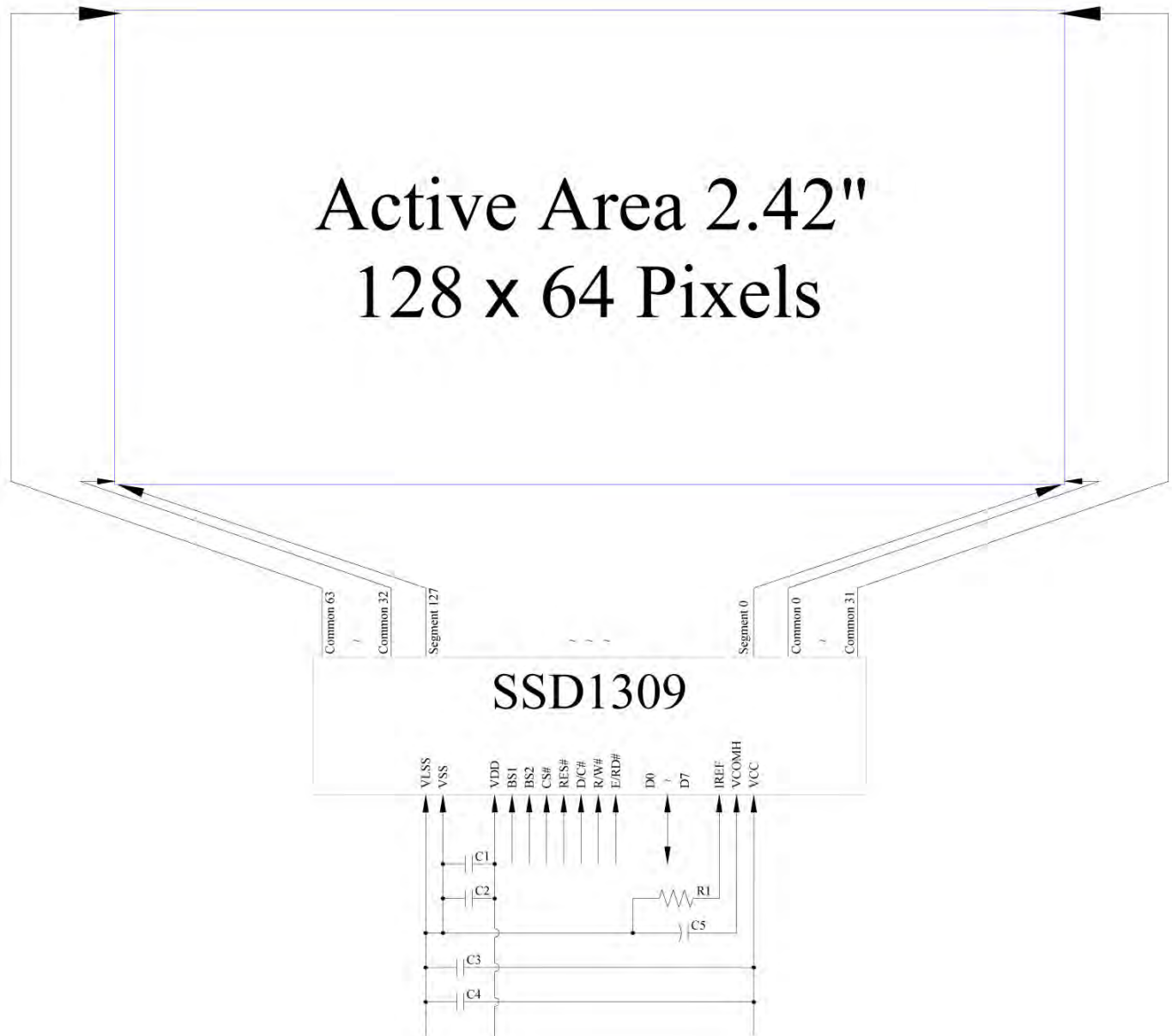

MCU Interface Selection: BS1 and BS2

Pins connected to MCU interface: D7~D0, E/RD#, R/W#, D/C#, RES#, and CS#

C1, C3: 0.1 μ F

C2: 4.7 μ F

C4: 10 μ F

C5: 4.7 μ F / 25V Tantalum Capacitor

R1: 910k Ω , $R1 = (\text{Voltage at IREF} - \text{BGGND}) / \text{IREF}$

DC Characteristics

Item	Symbol	Condition	Min.	Type	Max.	Unit
Supply Voltage for Logic	VDD		1.65	3~5	5.3	Volt
Supply Voltage for Display	VCC	Note 5	12.5	13.0	13.5	Volt
Operating Current for VDD	I _{DD}		-	180	300	μA
Operating Current for VCC	I _{CC}	Note 6	-	16.0	20.0	mA
		Note 7	-	23.2	29.1	mA
		Note 8	-	36.2	45.3	mA
Sleep Mode Current for VDD	I _{DD,SLEEP}		-	1	5	μA
Sleep Mode Current for VCC	I _{CC,SLEEP}		-	2	10	μA

Note 5: Brightness (Lbr) and Supply Voltage for Display (VCC) are subject to the change of the panel characteristics and the customer's request.

Note 6: VDD = 2.8V, VCC = 13.0V, 30% Display Area Turn on.

Note 7: VDD = 2.8V, VCC = 13.0V, 50% Display Area Turn on.

Note 8: VDD = 2.8V, VCC = 13.0V, 100% Display Area Turn on.

Optical Characteristics

Item	Symbol	Conditions	Min.	Typ	Max.	Unit
Brightness(White)	Lbr	Note 5		80	-	cd/m ²
C.I.E. (White)	(X)	C.I.E 1931	0.46	0.50	0.54	
	(Y)		0.45	0.49	0.53	
Dark Room Contrast	CR	-	-	>10000:1	-	
Viewing anglerrange	-	-	-	Free	-	Degree

* Optical measurement taken at VDD = 2.8V, VCC = 13.0V.



Absolute Maximum rating

Item	Symbol	Min.	Typ.	Max.	Unit	Notes
Supply Voltage for Logic	VDD	-0.3	-	5.5	Volt	1,2
Supply Voltage for Display	Vcc	0	-	15	Volt	1,2
Life Time (60 cd/m ²)		---	100,000	---	Hour	3

Note 1: All the above voltages are on the basis of "VSS = 0V".

Note 2: When this module is used beyond the above absolute maximum ratings, permanent breakage of the module may occur. Also, for normal operations, it is desirable to use this module under the conditions according to Section 3. "Optics". If this module is used beyond these conditions, malfunctioning of the module can occur and the reliability of the module may deteriorate.

Note 3: VCC = 13.0V, Ta = 25°C, 50% Checkerboard.

AC Characteristics

Please refer "SSD1309 specification.

MIDAS
DISPLAYS

DESIGN • MANUFACTURE • SUPPLY



Actual Application Example

Command usage and explanation of an actual example

<Power up Sequence>

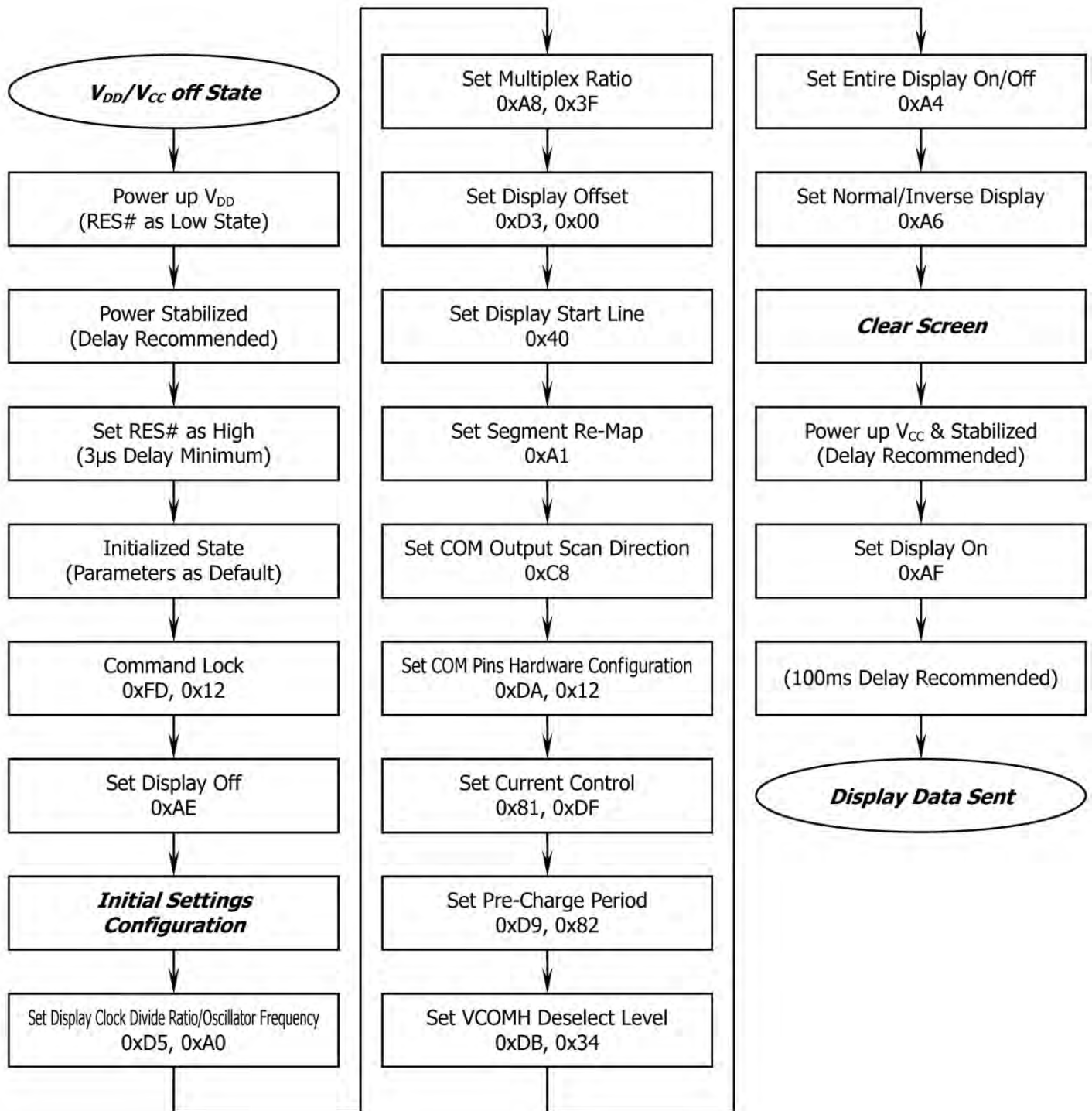

If the noise is accidentally occurred at the displaying window during the operation, please reset the display in order to recover the display function.

<Power down Sequence>



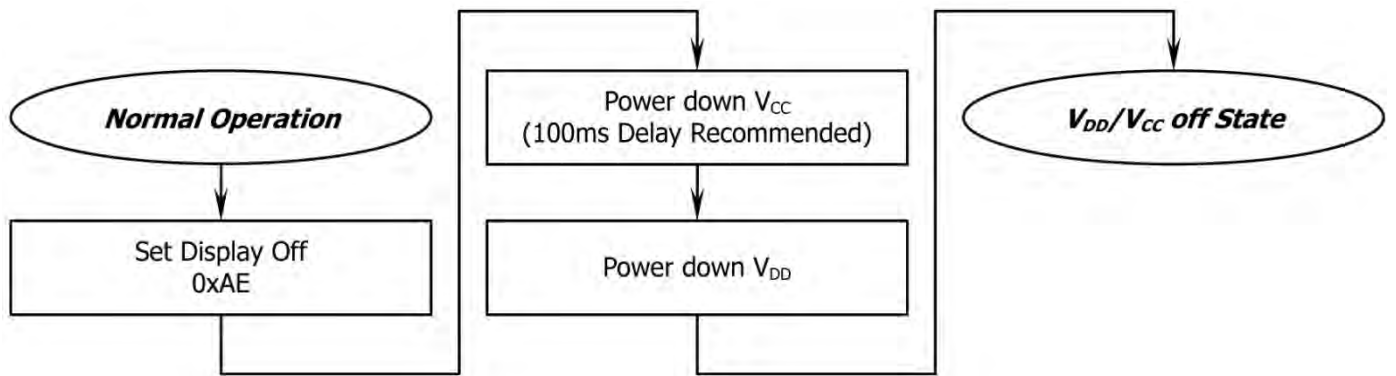

<Entering Sleep Mode>

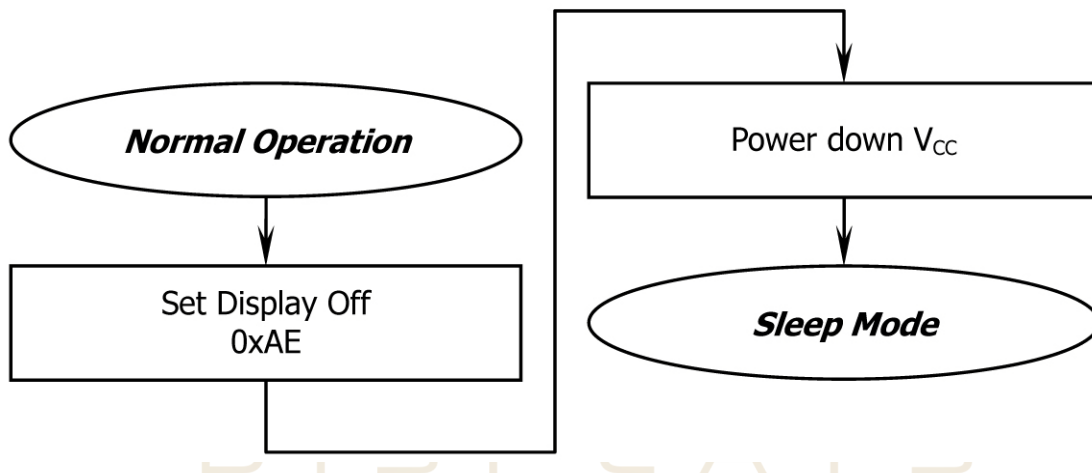

<Exiting Sleep Mode>

