



CIRCUIT-BREAKER SZ S00, FOR MOTOR PROTECTION, CLASS 10, W. OVERLOAD RELAY FUNCTION A-RELEASE 0.28...0.4A,N-RELEASE 5.2A SCREW CONNECTION, STANDARD SW. CAPACITY

product brand name		SIRIUS
Product designation		3RV2 circuit breaker

General technical data:		
Active power loss total typical	W	5
Insulation voltage		
• with degree of pollution 3 Rated value	V	690
Shock resistance		
• acc. to IEC 60068-2-27		25g / 11 ms
Surge voltage resistance Rated value	kV	6
Mechanical service life (switching cycles)		
• of the main contacts typical		100 000
• of the auxiliary contacts typical		100 000
Electrical endurance (switching cycles)		
• typical		100 000
Temperature compensation	°C	-20 ... +60
Size of contactor can be combined company-specific		S00
Protection class IP		
• on the front		IP20
• of the terminal		IP20
Type of protection		Increased safety
Equipment marking		
• acc. to DIN EN 81346-2		Q

Main circuit:		
Number of poles for main current circuit		3

Adjustable response value current of the current-dependent overload release	A	0.28 ... 0.4
Operating voltage		
• Rated value	V	690
• at AC-3 Rated value maximum	V	690
Operating frequency Rated value	Hz	50 ... 60
Operating current Rated value	A	0.4
Operating current		
• at AC-3		
— at 400 V Rated value	A	0.4
Operating power		
• at AC-3		
— at 230 V Rated value	W	60
— at 400 V Rated value	W	90
— at 500 V Rated value	W	120
— at 690 V Rated value	W	180
Operating frequency		
• at AC-3 maximum	1/h	15

Auxiliary circuit:

Number of NC contacts		
• for auxiliary contacts		0
Number of NO contacts		
• for auxiliary contacts		0
Number of CO contacts		
• for auxiliary contacts		0
Product expansion Auxiliary switch		Yes
Design of the auxiliary switch		laterally
Operating current of the auxiliary contacts at AC-15		
• at 24 V	A	1.5
• at 230 V	A	1.5
Operating current of the auxiliary contacts at DC-13		
• at 24 V	A	1

Protective and monitoring functions:

Trip class		CLASS 10
Design of the overload circuit breaker		thermal
Operational short-circuit current breaking capacity (Ics) with AC		
• at 240 V Rated value	kA	100
• at 400 V Rated value	kA	100
• at 500 V Rated value	kA	100
• at 690 V Rated value	kA	100
Maximum short-circuit current breaking capacity (Icu)		

• with AC at 240 V Rated value	kA	100
• with AC at 400 V Rated value	kA	100
• with AC at 500 V Rated value	kA	100
• with AC at 690 V Rated value	kA	100
Breaking capacity short-circuit current (I_{cn})		
• with 1 current path for DC at 150 V Rated value	kA	10
• with 2 current paths in series for DC at 300 V Rated value	kA	10
• with 3 current paths in series for DC at 450 V Rated value	kA	10
Response value current of the instantaneous short-circuit release	A	5.2

UL/CSA ratings:

Full-load current (FLA) for three-phase AC motor		
• at 480 V Rated value	A	0.4
• at 600 V Rated value	A	0.4
Contact rating of the auxiliary contacts acc. to UL		C600 / R300

Short-circuit:

Product function Short circuit protection		Yes
Design of the short-circuit trip		magnetic
Design of the fuse link		fuse gL/gG: 6 A, quick: 10 A
• for short-circuit protection of the auxiliary switch required		

Installation/ mounting/ dimensions:

mounting position		any
Mounting type		screw and snap-on mounting onto 35 mm standard mounting rail according to DIN EN 60715
Height	mm	97
Width	mm	65
Depth	mm	96
Required spacing		
• with side-by-side mounting		
— forwards	mm	0
— Backwards	mm	0
— upwards	mm	50
— downwards	mm	50
— at the side	mm	0
• for grounded parts		
— forwards	mm	0
— Backwards	mm	0
— upwards	mm	50
— at the side	mm	30

— downwards	mm	50
• for live parts		
— forwards	mm	0
— Backwards	mm	0
— upwards	mm	50
— downwards	mm	50
— at the side	mm	30

Connections/ Terminals:

Type of electrical connection		
• for main current circuit		screw-type terminals
• for auxiliary and control current circuit		screw-type terminals
Arrangement of electrical connectors for main current circuit		Top and bottom
Product function		
• removable terminal for auxiliary and control circuit		No
Type of connectable conductor cross-section		
• for main contacts		
— single or multi-stranded		2x (0,75 ... 2,5 mm ²), 2x 4 mm ²
— finely stranded with core end processing		2x (0.5 ... 1.5 mm ²), 2x (0.75 ... 2.5 mm ²)
• for AWG conductors for main contacts		2x (18 ... 14), 2x 12
• for auxiliary contacts		
— single or multi-stranded		2x (0,5 ... 1,5 mm ²), 2x (0,75 ... 2,5 mm ²)
— finely stranded with core end processing		2x (0.5 ... 1.5 mm ²), 2x (0.75 ... 2.5 mm ²)
• for AWG conductors for auxiliary contacts		2x (20 ... 16), 2x (18 ... 14)
Tightening torque		
• for main contacts with screw-type terminals	N·m	0.8 ... 1.2
Design of screwdriver shaft		Diameter 5 to 6 mm
Design of the thread of the connection screw		
• for main contacts		M3
• of the auxiliary and control contacts		M3

Safety related data:

B10 value with high demand rate acc. to SN 31920		50 000
Proportion of dangerous failures		
• with low demand rate acc. to SN 31920	%	40
• with high demand rate acc. to SN 31920	%	40
Failure rate [FIT] with low demand rate acc. to SN 31920	FIT	50
T1 value for proof test interval or service life acc. to IEC 61508	y	10
Protection against electrical shock		finger-safe

Mechanical data:

Size of the circuit-breaker		S00
-----------------------------	--	-----





Ambient conditions:

Installation altitude at height above sea level maximum	m	2 000
Ambient temperature		
• during operation	°C	-20 ... +60
• during storage	°C	-50 ... +80
• during transport	°C	-50 ... +80
Relative humidity during operation	%	10 ... 95

Display:

Display version		Handle
• for switching status		

Certificates/ approvals:

General Product Approval	Declaration of Conformity	Test Certificates
 CCC	 CSA	 EAC
	 EG-Konf.	Type Test Certificates/Test Report
		Special Test Certificate

Shipping Approval



Shipping Approval

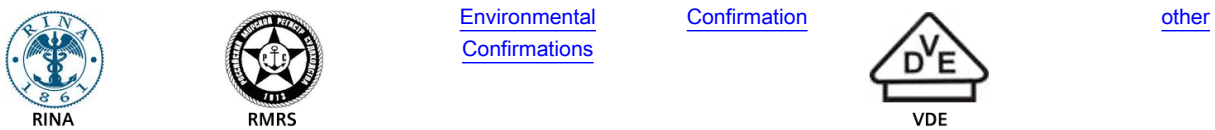

Further information

Information- and Downloadcenter (Catalogs, Brochures,...)

<http://www.siemens.com/industrial-controls/catalogs>

Industry Mall (Online ordering system)

<http://www.siemens.com/industrymall>

Cax online generator

<http://support.automation.siemens.com/WW/CAXorder/default.aspx?lang=en&mlfb=3RV21110EA10>

Service&Support (Manuals, Certificates, Characteristics, FAQs,...)

<http://support.automation.siemens.com/WW/view/en/3RV21110EA10/all>

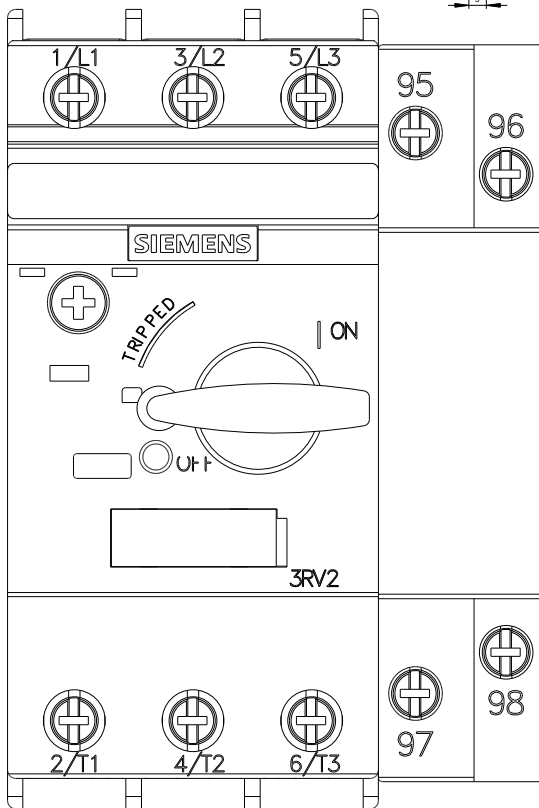
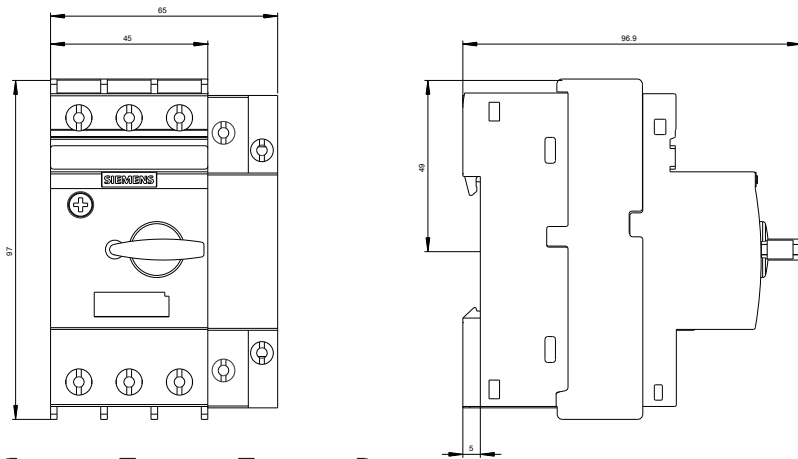

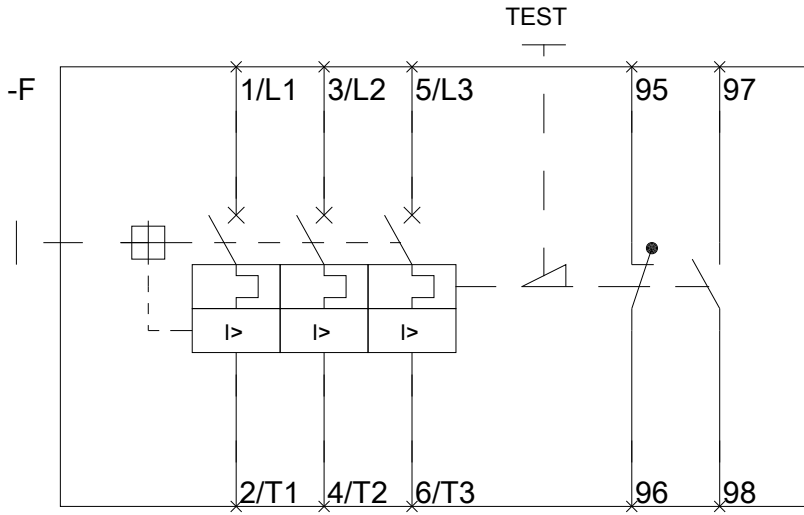

last modified:

11.03.2015