



## Specifications

### Electrical

Contact Rating : Silver : 5A at 120V AC or 28V DC, 2A at 250V AC  
 Max. Contact Resistance : 10mΩ  
 Min. Insulation Resistance : 1,000MΩ at 500V DC  
 Dielectric Strength : 1,000Vrms

### Mechanical



Life : 40,000 cycles

### Environmental

Operating Temperature : -30°C to +85°C

### Material

Case : DAP  
 Housing : Stainless steel  
 Actuator : Brass, chrome plated  
 Bushing : Brass, nickel plated  
 Support : Brass, tin plated  
 Contact / Terminals : Copper Alloy, Silver Plated

Model No.	Switching Position		
			
SPC21314 SPC21409	ON	ON	ON
SPC21315	MOM	ON	MOM
SPC21316	ON	ON	MOM
Conn. Terms	2-3 5-6	2-3 5-4	2-1 5-4

### For PC Mount Termination Only

#### PCB Layout Component Side

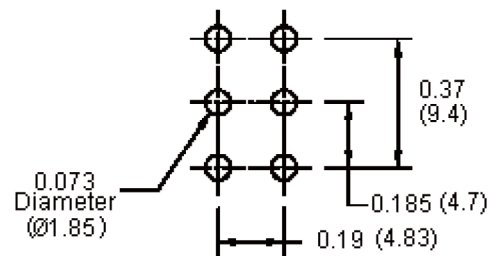

## Diagram

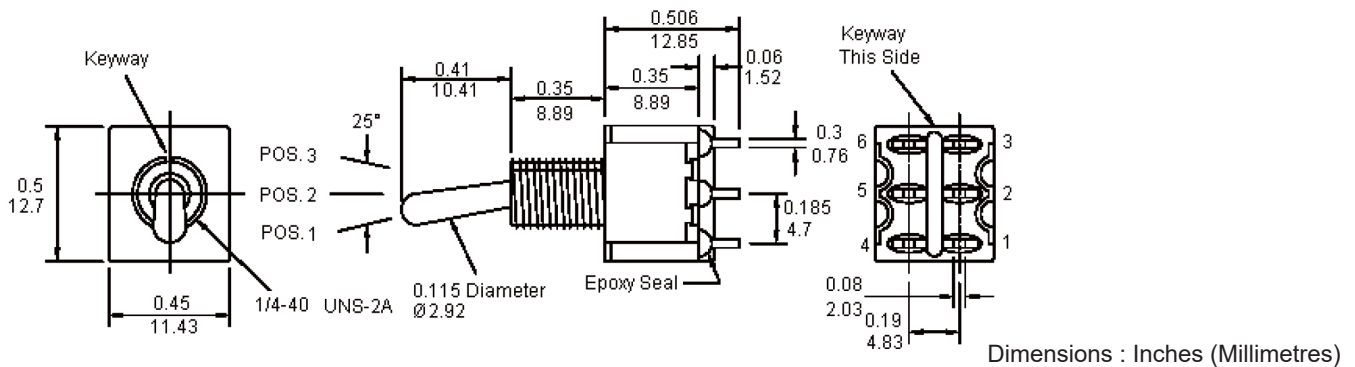

## Three - Way Switch Wiring Diagram

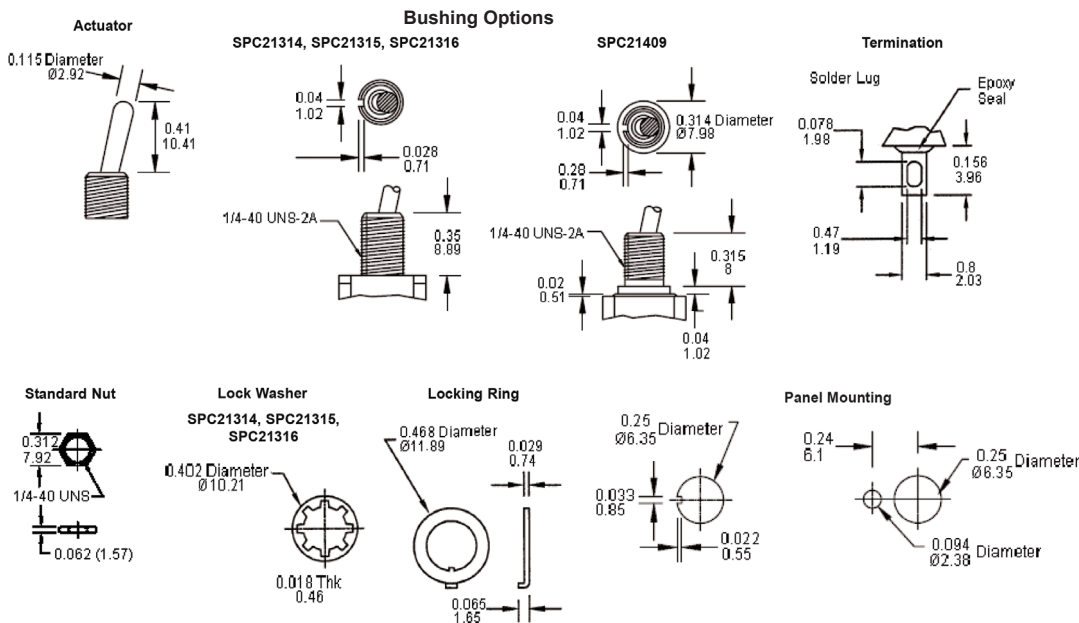
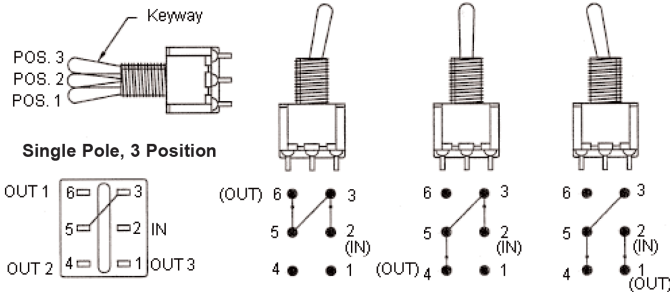

## Part Number Table

Description	Part Number
Toggle Switch, 5A, Panel Mount	SPC21314
	SPC21315
	SPC21316
	SPC21409

Dimensions : Inches (Millimetres)

**Important Notice :** This data sheet and its contents (the "Information") belong to the members of the AVNET group of companies (the "Group") or are licensed to it. No licence is granted for the use of it other than for information purposes in connection with the products to which it relates. No licence of any intellectual property rights is granted. The Information is subject to change without notice and replaces all data sheets previously supplied. The Information supplied is believed to be accurate but the Group assumes no responsibility for its accuracy or completeness, any error in or omission from it or for any use made of it. Users of this data sheet should check for themselves the Information and the suitability of the products for their purpose and not make any assumptions based on information included or omitted. Liability for loss or damage resulting from any reliance on the Information or use of it (including liability resulting from negligence or where the Group was aware of the possibility of such loss or damage arising) is excluded. This will not operate to limit or restrict the Group's liability for death or personal injury resulting from its negligence. Multicomp Pro is the registered trademark of Premier Farnell Limited 2019.